

OCTA UNIVERSAL

PANEL | FABRIC | LED

FREESTANDING WALLS
WITH A SYSTEM

TECHNICS 11/22

OCTANORM ®

CONTENT

OCTAUNIVERSAL

BASIC PARTS UPRIGHT	3
BASIC PARTS BEAM	10
BASIC PARTS FLOOR	15
ACCESSORIES	17
OCTALUMINA PLUS UNIVERSAL	21
KITS	29
KITS VARIABEL	35
TECHNICAL INFORMATION	41

BASIC PARTS UPRIGHT

OCTAuniversal

UPRIGHT

4-sided
80 × 80 mm



U 100-2500.09

aluminium
with mounting possibilities on 4 sides, comprising: 1 × upright U 100-2500oZ and 1 × adjustable foot M 1038D, 80 × 80 mm, 2525 mm long
5.86 kg

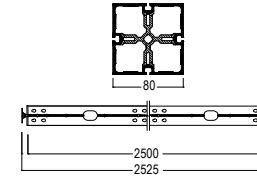

UPRIGHT

4-sided
80 × 80 mm



U 100-3000.09

aluminium
with mounting possibilities on 4 sides, comprising: 1 × upright U 100-3000oZ and 1 × adjustable foot M 1038D, 80 × 80 mm, 3025 mm long
0.31 kg

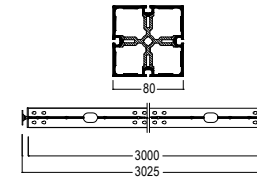

UPRIGHT
4-sided
80 × 80 mm



U 100-4000.09

aluminium
with mounting possibilities on 4 sides, comprising: 1 × upright U 100-2500oZ and 1 × upright U 100-1500oZ, 1 × straight connector U 350-0400 and 1 × adjustable foot M 1038D, 80 × 80 mm, 4025 mm long
9.898 kg

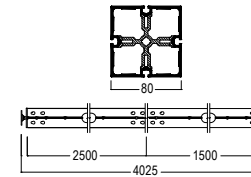

UPRIGHT
4-sided
80 × 80 mm



U 100-4500.09

aluminium
with mounting possibilities on 4 sides, comprising: 1 × upright U 100-3000oZ and 1 × upright U 100-1500oZ, 1 × straight connector U 350-0400 and 1 × adjustable foot M 1038D, 80 × 80 mm, 4525 mm long
4.348 kg

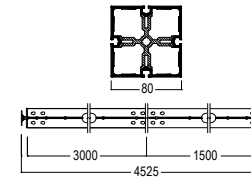

BASIC PARTS UPRIGHT

OCTAuniversal

UPRIGHT

4-sided
80 × 80 mm



U 100-5000.09

aluminium

with mounting possibilities on 4 sides, comprising: 2 × upright U 100-2500oZ, 1 × straight connector U 350-0400 and 1 × adjustable foot M 1038D, 80 × 80 mm, 5025 mm long
12.182 kg

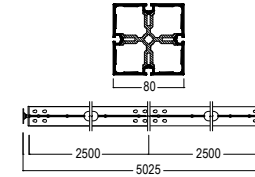

UPRIGHT

4-sided
80 × 80 mm



U 100-5500.09

aluminium

with mounting possibilities on 4 sides, comprising: 1 × upright U 100-3000oZ and 1 × upright U 100-2500oZ, 1 × straight connector U 350-0400 and 1 × adjustable foot M 1038D, 80 × 80 mm, 5525 mm long
6.632 kg

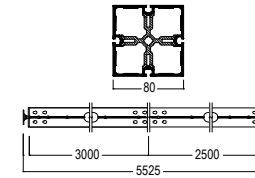

UPRIGHT
4-sided
80 × 80 mm



U 100-6000.09

aluminium
with mounting possibilities on 4 sides, comprising: 2 × upright U 100-3000oZ, 1 × straight connector U 350-0400 and 1 × adjustable foot M 1038D, 80 × 80 mm, 6025 mm long
1.082 kg

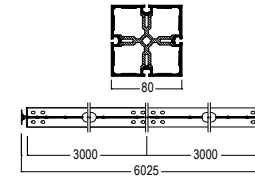

UPRIGHT
2-sided
80 × 80 mm



U 120-2500.09

aluminium
with mounting possibilities on 2 sides, comprising: 1 × upright U 120-2500oZ and 1 × adjustable foot M 1038D, 80 × 80 mm, 2525 mm long
5.944 kg

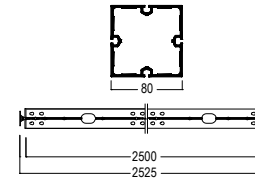

BASIC PARTS UPRIGHT

OCTAuniversal

UPRIGHT

2-sided
80 × 80 mm



U 120-3000.09

aluminium

with mounting possibilities on 2 sides, comprising: 1 × upright U 120-3000oZ and 1 × adjustable foot M 1038D, 80 × 80 mm, 3025 mm long
0.31 kg

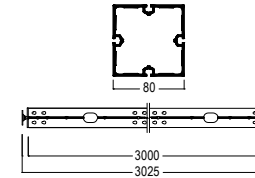

UPRIGHT

2-sided
80 × 80 mm



U 120-4000.09

aluminium

with mounting possibilities on 2 sides, comprising: 2 × upright U 120-2000oZ, 1 × straight connector U 350-0400 and 1 × adjustable foot M 1038D, 80 × 80 mm, 4025 mm long
10.02 kg

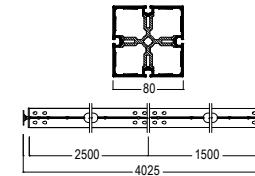

UPRIGHT

2-sided
80 × 80 mm



U 120-4500.09

aluminium

with mounting possibilities on 2 sides, comprising: 1 × upright U 100-3000oZ and 1 × upright U 100-1500oZ, 1 × straight connector U 350-0400 and 1 × adjustable foot M 1038D, 80 × 80 mm, 4525 mm long
4.386 kg

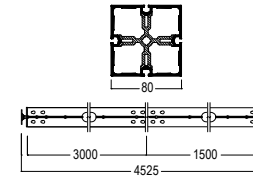

UPRIGHT

2-sided
80 × 80 mm



U 120-5000.09

aluminium

with mounting possibilities on 2 sides, comprising: upright 2 × U 120-2500oZ, 1 × straight connector U 350-0400 and 1 × adjustable foot M 1038D, 80 × 80 mm, 5025 mm long
12.35 kg

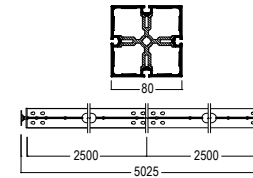

BASIC PARTS UPRIGHT

OCTAuniversal

UPRIGHT

2-sided
80 × 80 mm



U 120-5500.09

aluminium

with mounting possibilities on 2 sides, comprising: 1 × upright U 120-3000oZ and 1 × upright U 120-2500oZ, 1 × straight connector U 350-0400 and 1 × adjustable foot M 1038D, 80 × 80 mm, 5525 mm long
6.716 kg

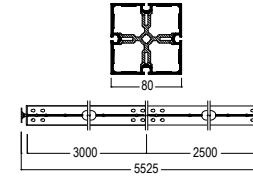

UPRIGHT

2-sided
80 × 80 mm



U 120-6000.09

aluminium

with mounting possibilities on 2 sides, comprising: 2 × upright U 120-3000oZ, 1 × straight connector U 350-0400 and 1 × adjustable foot M 1038D, 80 × 80 mm, 6025 mm long
1.082 kg

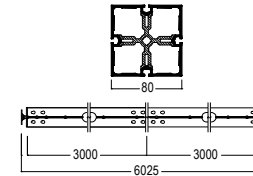

BEAM
for 990 mm grid
80 × 80 mm



U 200-0910.09

aluminium
for dimension between axis of 990 mm, with mounting possibilities, comprising: 1 × beam U 200-0910oZ, 1 × adaptor U 1103-L and 1 × adaptor U 1103-R, 80 × 80 mm, 910 mm long
1.087 kg

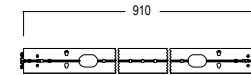

BEAM
for 1000 mm grid
80 × 80 mm



U 200-0920.09

aluminium
for axis measurement 1000 mm, with mounting possibilities, comprising: 1 × beam U 200-0920oZ, 1 × adaptor U 1103-L and 1 × adaptor U 1103-R, 80 × 80 mm, 920 mm long
3.101 kg

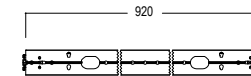

BASIC PARTS BEAM

OCTAuniversal

BEAM

for 990 mm grid
80 × 80 mm



U 200-1900.09

aluminium

for dimension between axis of 990 mm, with mounting possibilities, comprising: 1 × beam U 200-0920oZ, 1 × adaptor U 1103-L and 1 × adaptor U 1103-R, 80 × 80 mm, 1900 mm long
1.087 kg

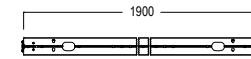

BEAM

for 1000 mm grid
80 × 80 mm



U 200-1920.09

aluminium

for axis measurement 1000 mm, with mounting possibilities, comprising: 1 × beam U 200-1920oZ, 1 × adaptor U 1103-L and 1 × adaptor U 1103-R, 80 × 80 mm, 1920 mm long
5.486 kg

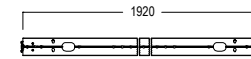

BEAM
variable
80 × 80 mm

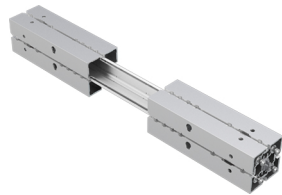

U 210-0480.09

aluminium

variable, with mounting possibilities, comprising: 2 × beam U 210-0480oZ, 1 × adaptor U 1103-L, 1 × adaptor U 1103-R, 1 × connector U 295-0280oZ and 16 × countersunk screw U 350-20 (M5), 80 × 80 mm, 480-620 mm
2.688 kg

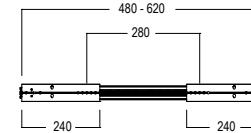

1 Variable beams are adjustable in 10 mm steps

BEAM
variable
80 × 80 mm



U 210-0560.09

aluminium

variable, with mounting possibilities, comprising: 2 × beam U 210-0560oZ, 1 × adaptor U 1103-L, 1 × adaptor U 1103-R, 1 × connector U 295-0360oZ and 16 × countersunk screw U 350-20 (M5), 80 × 80 mm, 560-800 mm long
1.755 kg

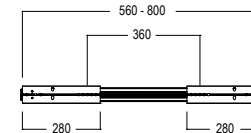

1 Variable beams are adjustable in 10 mm steps

BASIC PARTS BEAM

OCTAuniversal

BEAM
variable
80 × 80 mm



U 210-0720.09

aluminium
variable, with mounting possibilities, comprising: 2 × beam U 210-0720oZ, 1 × adaptor U 1103-L, 1 × adaptor U 1103-R, 1 × connector U 295-0520oZ and 16 × countersunk screw U 350-20 (M5), 80 × 80 mm, 720-1120 mm long
3.69 kg

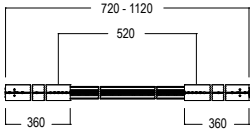

1 Variable beams are adjustable in 10 mm steps

BEAM
variable
80 × 80 mm



U 210-1120.09

aluminium
variable, with mounting possibilities, comprising: 2 × beam U 210-1120oZ, 1 × adaptor U 1103-L, 1 × adaptor U 1103-R, 1 × connector U 295-0920oZ and 16 × countersunk screw U 350-20 (M5), 80 × 80 mm, 1120-1920 mm long
5.327 kg

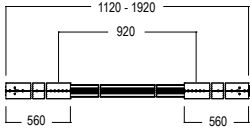

1 Variable beams are adjustable in 10 mm steps

BEAM
short
80 × 80 mm



U 240-0160.09

aluminium

short, for inside corners, with mounting possibilities,
comprising: 1 × beam single sided U 280-0160oZ and 1 ×
adaptor U 1107-16, 80 × 80 mm, 160 mm long
0.92 kg

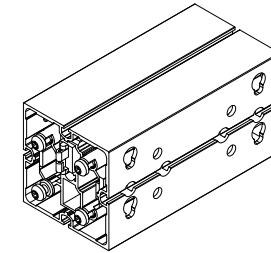
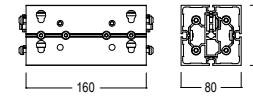

BASIC PARTS FLOOR

OCTAuniversal

FLOOR BALLASTING

for base plate U 10
L 900 × W 150 × H 50 mm

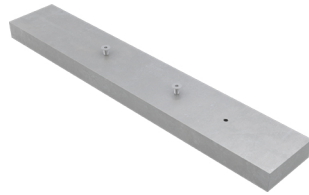

U 13.21

steel

as additional weight for floor panel U 10, incl. 2 × countersunk screw DFZ M12 × 40 (M12), L 900 × W 150 × H 50 mm
53 kg

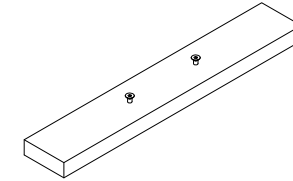
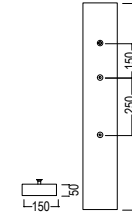

UPRIGHT FOOTING

for base plate U 10
L 398 × W 548 × H 395 mm



U 19.37

aluminium

to connect upright U 100 / U 120 with floor panel U 10, incl. 2 × connector U19-B, 2 × screw with slot U 19-20 (M12), 2 × washer M 530-40, L 398 × W 548 × H 395 mm
53.544 kg

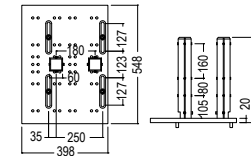

INTERNAL CONNECTOR

straight

L 420 × W 40 × H 40 mm



U 27.37

aluminium

straight, to connect two base plates U 10, incl. 4 × countersunk screw DFZ M12 × 40 (M12), L 420 × W 40 × H 40 mm
3.82 kg

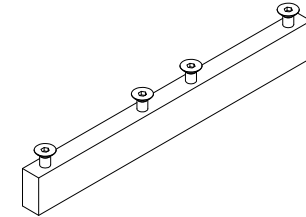
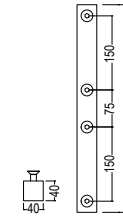

BASE PLATE

for sandwich panel SP 10

L 85 × W 85 × H 10 mm



U 29.37

aluminium

to connect the floor panel U 10 with sandwich panel SP 10 of OCTAclassic floor, incl. 2 × countersunk screw OL C422-20 (M8), 1 × set screw U 29-20 (M8), L 85 × W 85 × H 10 mm
0.355 kg

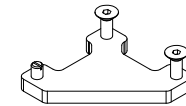
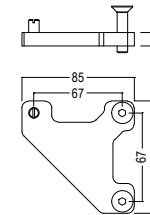

ACCESSORIES

OCTAuniversal

ADJUSTABLE FOOT

square
for extrusions 80 × 80 mm

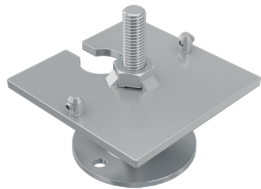

M 1038D.37

steel

for square extrusions 80 mm, thread M10, incl. 2 × set
screw M 1075/20 (M4), L 82 × W 82 × H 74 mm
0.31 kg

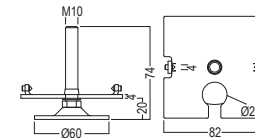

REINFORCEMENT

for system groove 4.3 mm
L 460 × W 460 × H 20 mm



U 300-0500.09

aluminium

for reinforcement of the frame construction of
OCTAuniversal, for system groove 4.3 mm, L 460 × W 460
× H 20 mm
2.15 kg

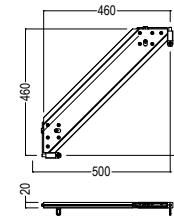

INTERNAL CONNECTOR

straight
57 × 57 mm



U 350-0400.00

aluminium
straight, for extension of uprights U 100 / U 120 vertical
with 8 × countersunk screw U 350-20 (M5), 57 × 57 mm,
400 mm long
0.772 kg

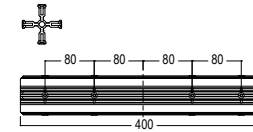

DISTANCE PIECE

single
L 100 × W 20 × H 72 mm



U 400-0100.09

aluminium
single, for flush mounting of 16 mm plates (in front of 120
mm upright), incl. 1 × mounting screw U 495, L 100 × W
20 × H 72 mm
1.584 kg

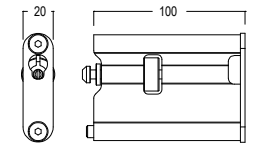

ACCESSORIES

OCTAuniversal

MOUNTING SCREW



U 495.37

zinc die cast/steel

with additional removing aid, 4 pieces per panel required
0.014 kg

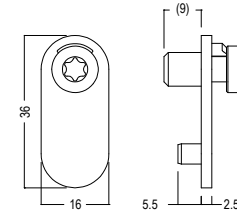

! Attention: 4 pieces per panel required

THREADED INSERT M8 for OC 2870 / U 495



OC 2880.37

steel

M8, to fix the panel screw OC 2870 and mounting screw U 495, for wall panels (16 mm and up), L 14 × W 14 × H 13 mm
0.005 kg

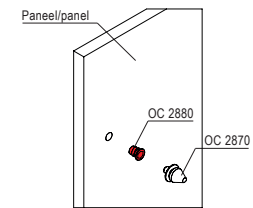
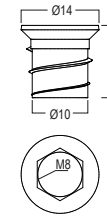

! Attention: required in combination with U 495

INTERNAL CONNECTOR
for extrusion U 1060 / U 1063
L 136 × W 20.6 × H 11.6 mm

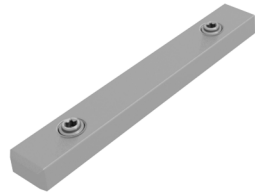

Z 984.00

aluminium
for extrusion U 1060 / U 1063, for lateral connection of frame extrusion with tension lock chamber 21 × 12 mm, with 2 × tension screw Z 985/S, L 136 × W 20.6 × H 11.6 mm
0.07 kg

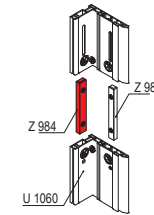
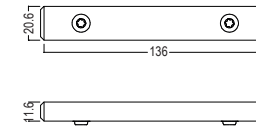

INTERNAL CONNECTOR
for extrusion U 1060 / U 1063
L 136 × W 15.9 × H 11.6 mm

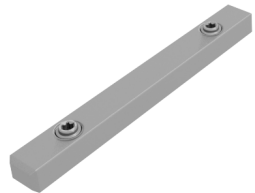

Z 985.00

aluminium
for extrusion U 1060 / U 1063, for lateral connection of frame profiles with 16 × 12 mm lock chamber, with 2 × clamping screw Z 985/S, L 136 × W 15.9 × H 11.6 mm
0.071 kg

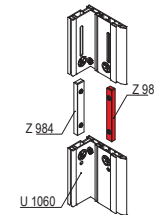
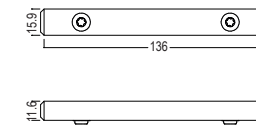

TENSION FABRIC ELEMENT

straight
120 × 66 mm



U 601-0500.01

aluminium
straight, made of tension fabric extrusion U 1060, with cable duct and 1 × cable protection U 600-N20, incl. 1 × straight connector Z 984 and 1 × straight connector Z 985, with 2 × suspension screw U 695 for mounting to upright U 100/U 120, 120 × 66 mm, 500 mm long
1.55 kg

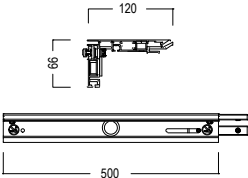

TENSION FABRIC ELEMENT

straight
120 × 66 mm



U 601-1000.01

aluminium
straight, made of tension fabric extrusion U 1060, with cable duct and 2 × cable protection U 600-N20, incl. 1 × straight connector Z 984 and 1 × straight connector Z 985, with 2 × suspension screw U 695 for mounting to upright U 100/U 120, 120 × 66 mm, 1000 mm long
2.65 kg

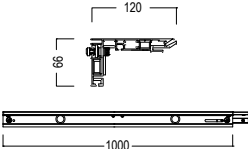

TENSION FABRIC ELEMENT

straight
120 × 66 mm



U 601-1500.01

aluminium
straight, made of tension fabric extrusion U 1060, with cable duct and 3 × cable protection U 600-N20, incl. 1 × straight connector Z 984 and 1 × straight connector Z 985, with 2 × suspension screw U 695 for mounting to upright U 100/U 120, 120 × 66 mm, 1500 mm long
4.33 kg

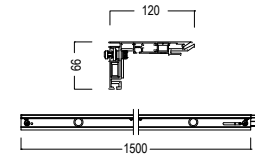

TENSION FABRIC ELEMENT

straight
120 × 66 mm



U 601-2000.01

aluminium
straight, made of tension fabric extrusion U 1060, with cable duct and 4 × cable protection U 600-N20, incl. 1 × straight connector Z 984 and 1 × straight connector Z 985, with 2 × suspension screw U 695 for mounting to upright U 100/U 120, 120 × 66 mm, 2000 mm long
5.13 kg

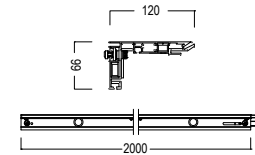

TENSION FABRIC ELEMENT

straight
120 × 66 mm



U 601-2500.01

aluminium

straight, made of tension fabric extrusion U 1060, with cable duct and 4 × cable protection U 600-N20, incl. 1 × straight connector Z 984 and 1 × straight connector Z 985, with 2 × suspension screw U 695 for mounting to upright U 100/U 120, 120 × 66 mm, 2500 mm long
6.435 kg

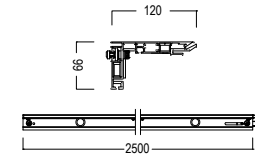

TENSION FABRIC ELEMENT

straight
120 × 66 mm



U 601-3000.01

aluminium

straight, made of tension fabric extrusion U 1060, with cable duct and 4 × cable protection U 600-N20, incl. 1 × straight connector Z 984 and 1 × straight connector Z 985, with 2 × suspension screw U 695 for mounting to upright U 100/U 120, 120 × 66 mm, 3000 mm long
0.704 kg

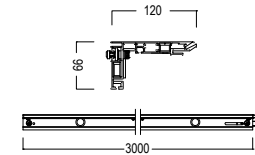

TENSION FABRIC ELEMENT

straight 135°
120 × 193 mm



U 603-0500.01

aluminium

straight 135°, made of tension fabric extrusion U 1063, with cable duct and 1 × cable protection U 600-N20, incl. 1 × straight connector Z 984 and 1 × straight connector Z 985, with 2 × suspension screw U 695 for mounting to upright U 100/U 120, 120 × 193 mm, 500 mm long

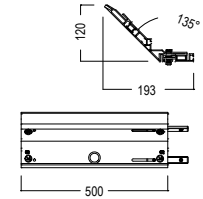

TENSION FABRIC ELEMENT

straight 135°
120 × 193 mm



U 603-1000.01

aluminium

straight 135°, made of tension fabric extrusion U 1063, with cable duct and 2 × cable protection U 600-N20, incl. 1 × straight connector Z 984 and 1 × straight connector Z 985, with 2 × suspension screw U 695 for mounting to upright U 100/U 120, 120 × 193 mm, 1000 mm long 3.54 kg

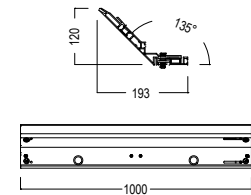

TENSION FABRIC ELEMENT

straight 135°
120 × 193 mm

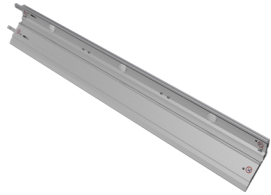

U 603-1500.01

aluminium

straight 135°, made of tension fabric extrusion U 1063, with cable duct and 3 × cable protection U 600-N20, incl. 1 × straight connector Z 984 and 1 × straight connector Z 985, with 2 × suspension screw U 695 for mounting to upright U 100/U 120, 120 × 193 mm, 1500 mm long

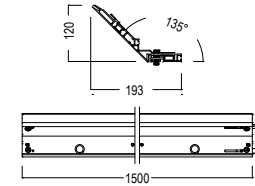

TENSION FABRIC ELEMENT

straight 135°
120 × 193 mm



U 603-2000.01

aluminium

straight 135°, made of tension fabric extrusion U 1063, with cable duct and 4 × cable protection U 600-N20, incl. 1 × straight connector Z 984 and 1 × straight connector Z 985, with 2 × suspension screw U 695 for mounting to upright U 100/U 120, 120 × 193 mm, 2000 mm long
6.702 kg

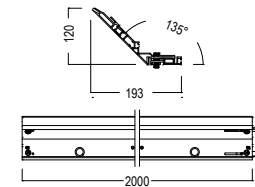

TENSION FABRIC ELEMENT

straight 135°
120 × 193 mm



U 603-2500.01

aluminium

straight 135°, made of tension fabric extrusion U 1063, with cable duct and 4 × cable protection U 600-N20, incl. 1 × straight connector Z 984 and 1 × straight connector Z 985, with 2 × suspension screw U 695 for mounting to upright U 100/U 120, 120 × 193 mm, 2500 mm long 8.662 kg

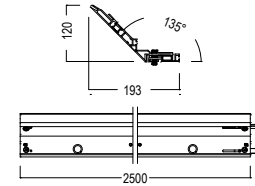

TENSION FABRIC ELEMENT

straight 135°
120 × 193 mm

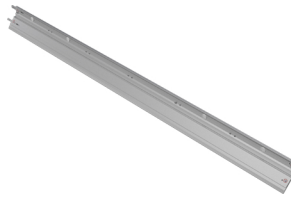

U 603-3000.01

aluminium

straight 135°, made of tension fabric extrusion U 1063, with cable duct and 4 × cable protection U 600-N20, incl. 1 × straight connector Z 984 and 1 × straight connector Z 985, with 2 × suspension screw U 695 for mounting to upright U 100/U 120, 120 × 193 mm, 3000 mm long

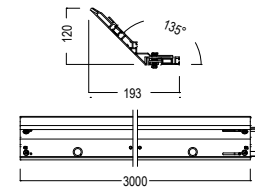

TENSION FABRIC CORNER

90° corner right/left
L 498 × W 120 × H 498 mm



U 610-0498.01

aluminium

90° corner right/left, made of tension fabric extrusion U 1060, with cable duct and 2 × cable protection U 600-N20, incl. 1 × straight connector Z 984 and 1 × Verbindungsteil gerade Z 985, with 2 × suspension screw U 695 for mounting to upright U 100/U 120, L 498 × W 120 × H 498 mm
2.75 kg

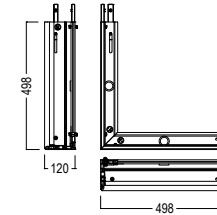

TENSION FABRIC CORNER

135° corner right
L 500 × W 120 × H 498 mm



U 615-0498.01

aluminium

135° corner right, made of tension fabric extrusion U 1060 and U 1063, with cable duct and 2 × cable protection U 600-N20, incl. 1 × straight connector Z 984 and 1 × straight connector Z 985, with 2 × suspension screw U 695 for mounting to upright U 100/U 120, L 500 × W 120 × H 498 mm
3 kg

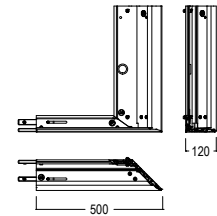

TENSION FABRIC CORNER

135° corner left
L 500 × W 120 × H 498 mm



U 616-0498.01

aluminium

135° corner left, made of tension fabric extrusion U 1060 and U 1063, with cable duct and 2 × cable protection U 600-N20, incl. 1 × straight connector Z 984 and 1 × Verbindungsteil gerade Z 985, with 2 × suspension screw U 695 for mounting to upright U 100/U 120, L 500 × W 120 × H 498 mm
2.99 kg

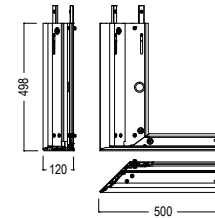

TENSION FABRIC CORNER

Corner right/left
L 500 × W 120 × H 498 mm



U 619-0498.01

aluminium

corner right/left, made of tension fabric extrusion U 1060 and U 1063, with cable duct and 2 × cable protection U 600-N20, incl. 1 × straight connector Z 984 and 1 × Verbindungsteil gerade Z 985, with 2 × suspension screw U 695 for mounting to upright U 100/U 120, L 500 × W 120 × H 498 mm

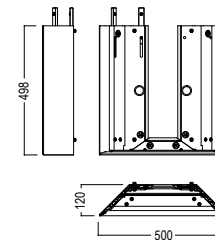

FREESTANDING WALL

Kit
1080 × 4000 mm

U WH14.09

aluminium

Kit, 1 × freestanding frame with a total depth of 260 mm: comprising 2 × single frame with an extrusion depth of 80 mm, connected with connecting beams U 280-0100, incl. 4 × base plate U 10, dimensions w/o base plates: B 1080 × H 4000 × D 260 mm, dimensions with base plates: W 1998 × H 4126 × D 1998 mm
741.256 kg

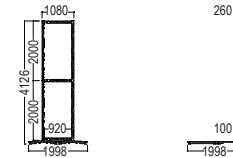

! Attention: Maximum load for cladding in front of uprights with a distance of 120 mm: 15 kg/m²

FREESTANDING WALL

Kit
1080 × 5000 mm

U WH15.09

aluminium

Kit, 1 × freestanding frame with a total depth of 260 mm: comprising 2 × single frame with an extrusion depth of 80 mm, connected with connecting beams U 280-0100, incl. 4 × base plate U 10, dimensions w/o base plates: B 1080 × H 5000 × D 260 mm, dimensions with base plates: W 1998 × H 5126 × D 1998 mm
750.392 kg

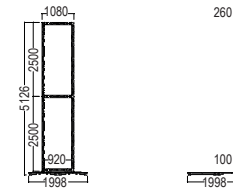

! Attention: Maximum load for cladding in front of uprights with a distance of 120 mm: 15 kg/m²

FREESTANDING WALL

Kit
1080 × 6000 mm

U WH16.09

aluminium

Kit, 1 × freestanding frame with a total depth of 260 mm: comprising 2 × single frame with an extrusion depth of 80 mm, connected with connecting beams U 280-0100, incl. 4 × base plate U 10, dimensions w/o base plates: B 1080 × H 6000 × D 260 mm, dimensions with base plates: W 1998 × H 6126 × D 1998 mm
759.272 kg

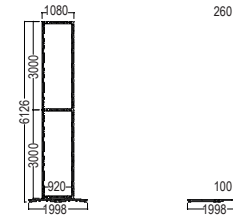

! Attention: Maximum load for cladding in front of uprights with a distance of 120 mm: 15 kg/m²

FREESTANDING WALL

Kit
2080 × 4000 mm

U WH24.09

aluminium

Kit, 1 × freestanding frame with a total depth of 260 mm: comprising 2 × single frame with an extrusion depth of 80 mm, connected with connecting beams U 280-0100, incl. 4 × base plate U 10, dimensions w/o base plates: B 2080 × H 4000 × D 260 mm, dimensions with base plates: W 2998 × H 4126 × D 1998 mm
755.566 kg

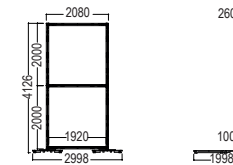

! Attention: Maximum load for cladding in front of uprights with a distance of 120 mm: 15 kg/m²

FREESTANDING WALL

Kit
2080 × 5000 mm

U WH25.09

aluminium

Kit, 1 × freestanding frame with a total depth of 260 mm: comprising 2 × single frame with an extrusion depth of 80 mm, connected with connecting beams U 280-0100, incl. 4 × base plate U 10, dimensions w/o base plates: B 2080 × H 5000 × D 260 mm, dimensions with base plates: W 2998 × H 5126 × D 1998 mm
764.702 kg

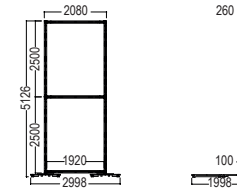

! Attention: Maximum load for cladding in front of uprights with a distance of 120 mm: 15 kg/m²

FREESTANDING WALL

Kit
2080 × 6000 mm

U WH26.09

aluminium

Kit, 1 × freestanding frame with a total depth of 260 mm: comprising 2 × single frame with an extrusion depth of 80 mm, connected with connecting beams U 280-0100, incl. 4 × base plate U 10, dimensions w/o base plates: B 2080 × H 6000 × D 260 mm, dimensions with base plates: W 2998 × H 6126 × D 1998 mm
773.582 kg

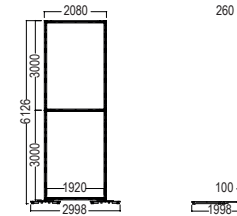

! Attention: Maximum load for cladding in front of uprights with a distance of 120 mm: 15 kg/m²

FREESTANDING WALL

Kit
4080 × 4000 mm

U WH44.09

aluminium

Kit, 1 × freestanding frame with a total depth of 260 mm: comprising 2 × single frame with an extrusion depth of 80 mm, connected with connecting beams U 280-0100, incl. 6 × base plate U 10, dimensions w/o base plates: B 4080 × H 4000 × D 260 mm, dimensions with base plates: W 4998 × H 4126 × D 1998 mm
1150.051 kg

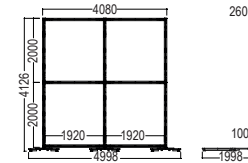

! Attention: Maximum load for cladding in front of uprights with a distance of 120 mm: 15 kg/m²

FREESTANDING WALL

Kit
4080 × 5000 mm

U WH45.09

aluminium

Kit, 1 × freestanding frame with a total depth of 260 mm: comprising 2 × single frame with an extrusion depth of 80 mm, connected with connecting beams U 280-0100, incl. 6 × base plate U 10, dimensions w/o base plates: B 4080 × H 5000 × D 260 mm, dimensions with base plates: W 4998 × H 5126 × D 1998 mm
1163.847 kg

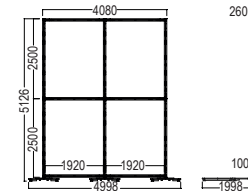

! Attention: Maximum load for cladding in front of uprights with a distance of 120 mm: 15 kg/m²

FREESTANDING WALL

Kit
4080 × 6000 mm



U WH46.09

aluminium

Kit, 1 × freestanding frame with a total depth of 260 mm: comprising 2 × single frame with an extrusion depth of 80 mm, connected with connecting beams U 280-0100, incl. 6 × base plate U 10, dimensions w/o base plates: B 4080 × H 6000 × D 260 mm, dimensions with base plates: W 4998 × H 6126 × D 1998 mm
1336.293 kg

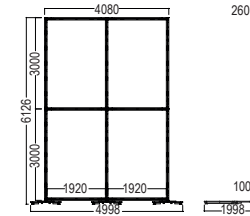

! Attention: Maximum load for cladding in front of uprights with a distance of 120 mm: 15 kg/m²

FREESTANDING WALL

Kit
6080 × 4000 mm

U WH64.09

aluminium

Kit, 1 × freestanding frame with a total depth of 260 mm: comprising 2 × single frame with an extrusion depth of 80 mm, connected with connecting beams U 280-0100, incl. 8 × base plate U 10, dimensions w/o base plates: B 6080 × H 4000 × D 260 mm, dimensions with base plates: W 6998 × H 4126 × D 1998 mm
1544.536 kg

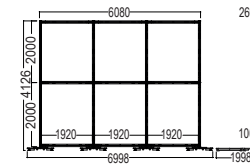

! Attention: Maximum load for cladding in front of uprights with a distance of 120 mm: 15 kg/m²

FREESTANDING WALL

Kit
6080 × 5000 mm

U WH65.09

aluminium

Kit, 1 × freestanding frame with a total depth of 260 mm: comprising 2 × single frame with an extrusion depth of 80 mm, connected with connecting beams U 280-0100, incl. 8 × base plate U 10, dimensions w/o base plates: B 6080 × H 5000 × D 260 mm, dimensions with base plates: W 6998 × H 5126 × D 1998 mm
1562.992 kg

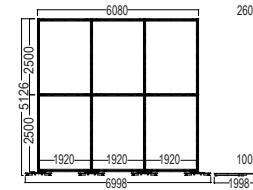

! Attention: Maximum load for cladding in front of uprights with a distance of 120 mm: 15 kg/m²

FREESTANDING WALL

Kit
6080 × 6000 mm

U WH66.09

aluminium

Kit, 1 × freestanding frame with a total depth of 260 mm: comprising 2 × single frame with an extrusion depth of 80 mm, connected with connecting beams U 280-0100, incl. 8 × base plate U 10, dimensions w/o base plates: B 6080 × H 6000 × D 260 mm, dimensions with base plates: W 6998 × H 6126 × D 1998 mm
2005.152 kg

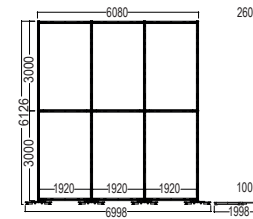

! Attention: Maximum load for cladding in front of uprights with a distance of 120 mm: 15 kg/m²

KITS VARIABEL

OCTAuniversal

FREESTANDING WALL

Kit variable
720-960 × 4000 mm

U WH14V.09

aluminium

Kit variable, 1 × freestanding frame with a total depth of 260 mm: comprising 2 × single frame with an extrusion depth of 80 mm, connected with connecting beams U 280-0100, incl. 4 × base plate U 10, dimensions w/o base plates: W 720-960 × H 4000 × D 260 mm, dimensions with base plates: W 1998-2498 × H 4126 × D 1998 mm
743.71 kg

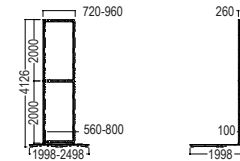

! Attention: Maximum load for cladding in front of uprights with a distance of 120 mm: 15 kg/m²

FREESTANDING WALL

Kit variable
720-960 × 5000 mm

U WH15V.09

aluminium

Kit variable, 1 × freestanding frame with a total depth of 260 mm: comprising 2 × single frame with an extrusion depth of 80 mm, connected with connecting beams U 280-0100, incl. 4 × base plate U 10, dimensions w/o base plates: W 720-960 × H 5000 × D 260 mm, dimensions with base plates: W 1998-2498 × H 5126 × D 1998 mm
742.316 kg

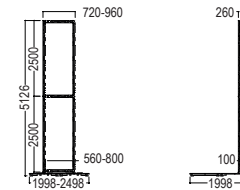

! Attention: Maximum load for cladding in front of uprights with a distance of 120 mm: 15 kg/m²

FREESTANDING WALL

Kit variable
720-960 × 6000 mm

U WH16V.09

aluminium

Kit variable, 1 × freestanding frame with a total depth of 260 mm: comprising 2 × single frame with an extrusion depth of 80 mm, connected with connecting beams U 280-0100, incl. 4 × base plate U 10, dimensions w/o base plates: W 720-960 × H 6000 × D 260 mm, dimensions with base plates: W 1998-2498 × H 6126 × D 1998 mm
751.196 kg

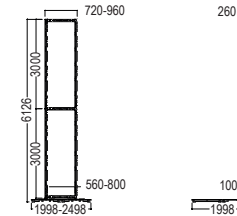

! Attention: Maximum load for cladding in front of uprights with a distance of 120 mm: 15 kg/m²

FREESTANDING WALL

Kit variable
1280-2080 × 4000 mm

U WH24V.09

aluminium

Kit variable, 1 × freestanding frame with a total depth of 260 mm: comprising 2 × single frame with an extrusion depth of 80 mm, connected with connecting beams U 280-0100, incl. 4 × base plate U 10, dimensions w/o base plates: W 1280-2080 × H 4000 × D 260 mm, dimensions with base plates: W 1998-2998 × H 4126 × D 1998 mm
754.612 kg



! Attention: Maximum load for cladding in front of uprights with a distance of 120 mm: 15 kg/m²

KITS VARIABEL

OCTAuniversal

FREESTANDING WALL

Kit variable
1280-2080 × 5000 mm

U WH25V.09

aluminium

Kit variable, 1 × freestanding frame with a total depth of 260 mm: comprising 2 × single frame with an extrusion depth of 80 mm, connected with connecting beams U 280-0100, incl. 4 × base plate U 10, dimensions w/o base plates: W 1280-2080 × H 5000 × D 260 mm, dimensions with base plates: W 1998-2998 × H 5126 × D 1998 mm 763.748 kg

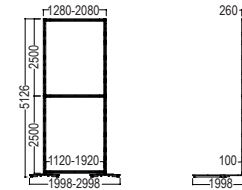

! Attention: Maximum load for cladding in front of uprights with a distance of 120 mm: 15 kg/m²

FREESTANDING WALL

Kit variable
1280-2080 × 6000 mm

U WH26V.09

aluminium

Kit variable, 1 × freestanding frame with a total depth of 260 mm: comprising 2 × single frame with an extrusion depth of 80 mm, connected with connecting beams U 280-0100, incl. 4 × base plate U 10, dimensions w/o base plates: B 1280-2080 × H 6000 × D 260 mm, dimensions with base plates: W 1998-2998 × H 6126 × D 1998 mm 772.628 kg

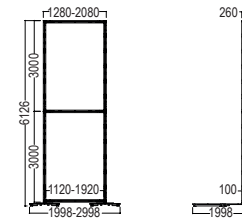

! Attention: Maximum load for cladding in front of uprights with a distance of 120 mm: 15 kg/m²

FREESTANDING WALL

Kit variable
2480-4080 × 4000 mm

U WH44V.09

aluminium

Kit variable, 1 × freestanding frame with a total depth of 260 mm: comprising 2 × single frame with an extrusion depth of 80 mm, connected with connecting beams U 280-0100, incl. 6 × base plate U 10, dimensions w/o base plates: W 2480-4080 × H 4000 × D 260 mm, dimensions with base plates: W 2998-3998 × H 4126 × D 1998 mm 1148.143 kg

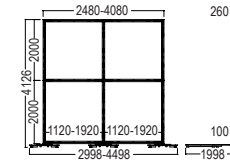

! Attention: Maximum load for cladding in front of uprights with a distance of 120 mm: 15 kg/m²

FREESTANDING WALL

Kit variable
2480-4080 × 5000 mm

U WH45V.09

aluminium

Kit variable, 1 × freestanding frame with a total depth of 260 mm: comprising 2 × single frame with an extrusion depth of 80 mm, connected with connecting beams U 280-0100, incl. 6 × base plate U 10, dimensions w/o base plates: W 2480-4080 × H 5000 × D 260 mm, dimensions with base plates: W 2998-3998 × H 5126 × D 1998 mm 1161.939 kg

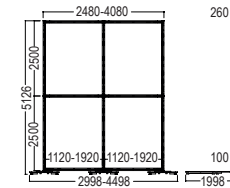

! Attention: Maximum load for cladding in front of uprights with a distance of 120 mm: 15 kg/m²

KITS VARIABEL

OCTAuniversal

FREESTANDING WALL

Kit variable
2480-4080 × 6000 mm

U WH46V.09

aluminium

Kit variable, 1 × freestanding frame with a total depth of 260 mm: comprising 2 × single frame with an extrusion depth of 80 mm, connected with connecting beams U 280-0100, incl. 6 × base plate U 10, dimensions w/o base plates: W 2480-4080 × H 6000 × D 260 mm, dimensions with base plates: W 2998-3998 × H 6126 × D 1998 mm
1334.385 kg

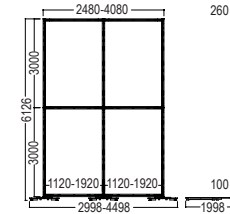

! Attention: Maximum load for cladding in front of uprights with a distance of 120 mm: 15 kg/m²

FREESTANDING WALL

Kit variable
4480-6080 × 4000 mm

U WH64V.09

aluminium

Kit variable, 1 × freestanding frame with a total depth of 260 mm: comprising 2 × single frame with an extrusion depth of 80 mm, connected with connecting beams U 280-0100, incl. 8 × base plate U 10, dimensions w/o base plates: W 4480-6080 × H 4000 × D 260 mm, dimensions with base plates: W 4498-6998 × H 4126 × D 1998 mm
1498.628 kg

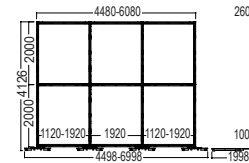

! Attention: Maximum load for cladding in front of uprights with a distance of 120 mm: 15 kg/m²

FREESTANDING WALL

Kit variable
4480-6080 × 5000 mm

U WH65V.09

aluminium

Kit variable, 1 × freestanding frame with a total depth of 260 mm: comprising 2 × single frame with an extrusion depth of 80 mm, connected with connecting beams U 280-0100, incl. 8 × base plate U 10, dimensions w/o base plates: W 4480-6080 × H 5000 × D 260 mm, dimensions with base plates: W 4498-6998 × H 5126 × D 1998 mm

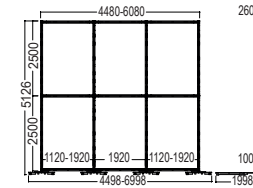

! Attention: Maximum load for cladding in front of uprights with a distance of 120 mm: 15 kg/m²

FREESTANDING WALL

Kit variable
4480-6080 × 6000 mm



U WH66V.09

aluminium

Kit variable, 1 × freestanding frame with a total depth of 260 mm: comprising 2 × single frame with an extrusion depth of 80 mm, connected with connecting beams U 280-0100, incl. 8 × base plate U 10, dimensions w/o base plates: W 4480-6080 × H 6000 × D 260 mm, dimensions with base plates: W 4498-6998 × H 6126 × D 1998 mm

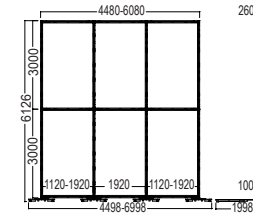

! Attention: Maximum load for cladding in front of uprights with a distance of 120 mm: 15 kg/m²

TECHNICAL INFORMATION

TI-U-010 Bracing panel	44
TI-U-2.0 Compositions of kits	45
TI-U-2.1 Compositions of kits variable	47
TI-U-4.0 Floor ballasting 2 meters - edge	49
TI-U-4.1 Floor ballasting 2 meters - middle	50
TI-U-4.2 Floor ballasting 4 meters - edge	51
TI-U-4.3 Floor ballasting 4 meters - middle	52
TI-U-4.5 Floor ballasting 6 meters - middle	53
TI-U-A Drilling pattern for mounting panel Type A	54
TI-U-BL020 Drilling pattern for mounting panel Type B-L20 left	55
TI-U-BL120 Drilling pattern for mounting panel Type B-L 120 left	56

TECHNICAL INFORMATION

TI-U-BR020	57
Drilling pattern for mounting panel Type B-R20 right	
TI-U-BR120	58
Drilling pattern for mounting panel Type B-R 120 right	
TI-U-BS-A001	59
Example cross section L-wall M 1915 depth 120 mm	
TI-U-BS-A002	60
Example cross section L-wall M 1901 depth 120 mm	
TI-U-BS-C001	61
Example cross section freestanding wall depth 300 mm	
TI-U-BS-D001	62
Example cross section freestanding wall depth 400 mm	
TI-U-BS-E001	63
Example cross section freestanding wall depth 500 mm	
TI-U-LED010	64
Arrangement LED modules	
TI-U-P20.0	65
Drilling pattern for mounting panels type A 20 + 120 mm to OCTAuniversal	
TI-U-S01	66
U 695 Mounting screw for frame elements OCTAlumina plus universal	
TI-U-S30.0	67
Fabric dimensions for hanging frame OCTAlumina plus universal type A	

TECHNICAL INFORMATION

TI-U-S30.1	68
Exploded drawing frame element OCTALumina plus universal type A	
TI-U-S31.0	69
Fabric dimensions for hanging frame OCTALumina plus universal type B	
TI-U-S31.1	70
Exploded drawing frame element OCTALumina plus universal type B	
TI-U-S32.0	71
Fabric dimensions for hanging frame OCTALumina plus universal type C	
TI-U-S32.1	72
Exploded drawing frame element OCTALumina plus universal type C	
TI-U-U10-U19	73
Assembly positions upright footing U 19	
TI-U-U19	74
Assembly position upright footing U 19	
TI-U-U19-1	75
Assembly position connector U 19-B	
TI-U-WH6654	76
Kit 6 m width subconstruction	
TI-U-WH6654V	77
Kit variable 6 m width subconstruction	

BRACING PANEL

TI-U-010

IMPORTANT INFORMATION!

Bracing panel made of plywood (with grooves on all edges)
F/2010 E 40/20 as per EN 123692 : 201106

(The bracing panel is part of the stability proof. Material, quality and design are imperative!)

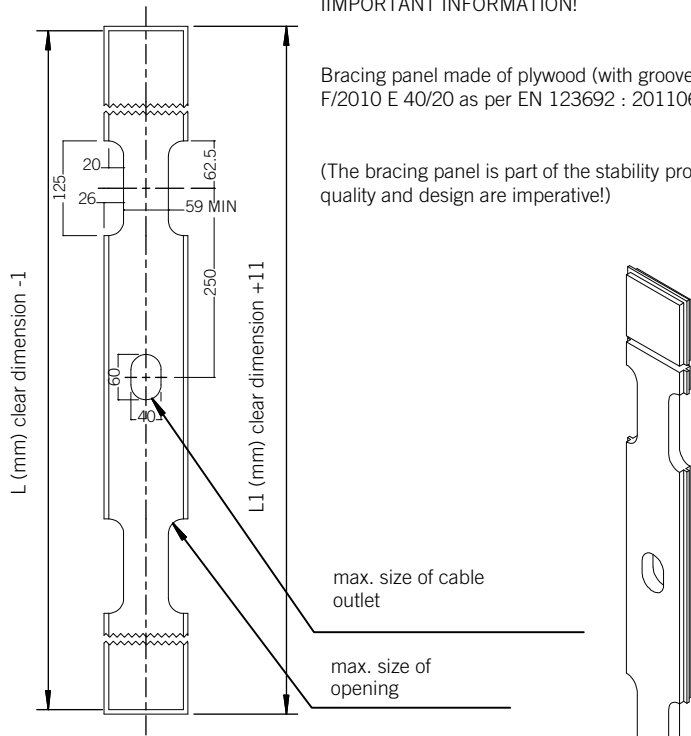

max. size of cable outlet

max. size of opening

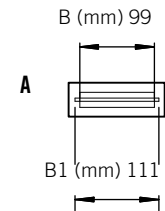

All dimensions are in mm!

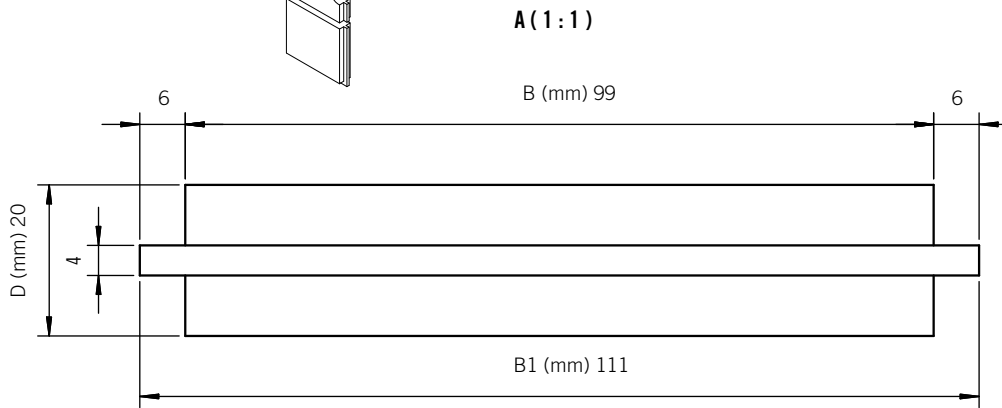

A (1:1)

Bracing panel with max. of cable outlets and openings!

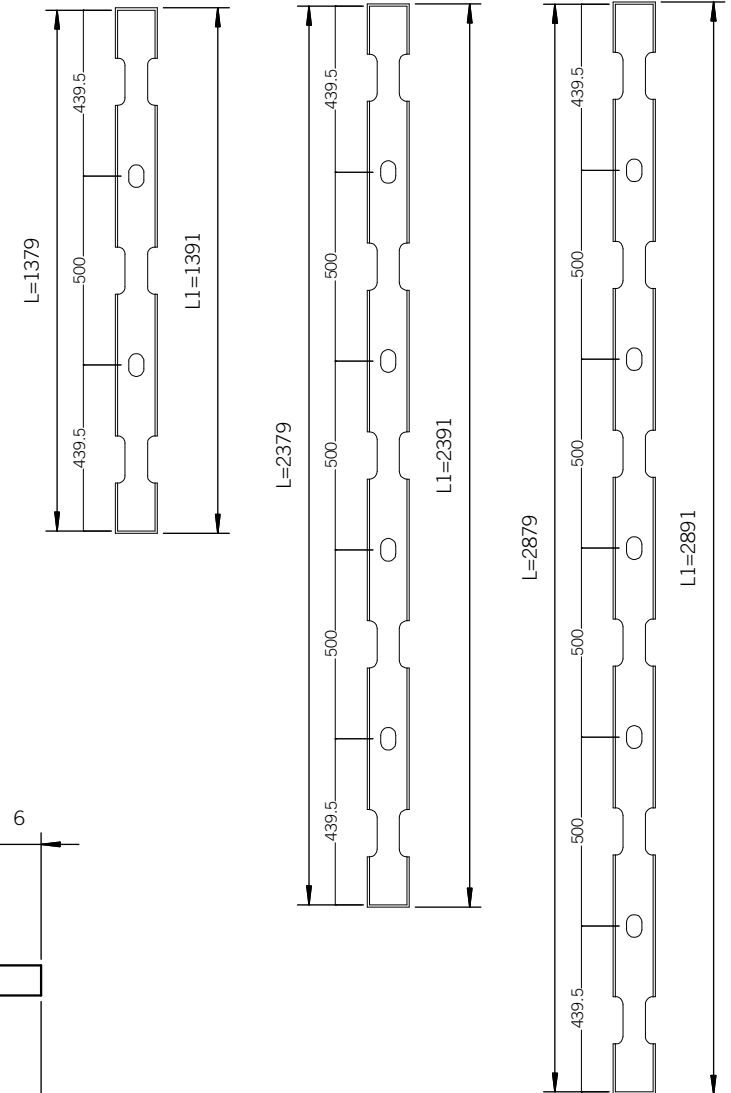

TI-U-010.D E-000605 0599A T00 A

U WH16

Width: 1080 mm, Height: 6125 mm

U 350-0400	4
U 100-3000oZ	8
U 200-0920	6
U 280-0100	6
U 10	4
U 27	4
U 19	2
Bracing panel 2879 mm	4

U WH15

Width: 1080 mm, Height: 5125 mm

U 350-0400	4
U 100-2500oZ	8
U 200-0920	6
U 280-0100	6
U 10	4
U 27	4
U 19	2
Bracing panel 2379 mm	4

U WH14

Width: 1080 mm, Height: 4125 mm

U 350-0400	4
U 100-1500oZ	4
U 100-2500oZ	4
U 200-0920	6
U 280-0100	6
U 10	4
U 27	4
U 19	2
Bracing panel 2379 mm	2
Bracing panel 1379 mm	2

! Attention!
Bracing panel is not included in kit.
See technical information TI-U-010

U WH26

Width: 2080 mm, Height: 6125 mm

U 350-0400	4
U 100-3000oZ	8
U 200-1920	6
U 280-0100	6
U 10	4
U 27	4
U 19	2
Bracing panel 2879 mm	4

U WH25

Width: 2080 mm, Height: 5125 mm

U 350-0400	4
U 100-2500oZ	8
U 200-1920	6
U 280-0100	6
U 10	4
U 27	4
U 19	2
Bracing panel 2379 mm	4

U WH24

Width: 2080 mm, Height: 4125 mm

U 350-0400	4
U 100-1500oZ	4
U 100-2500oZ	4
U 200-1920	6
U 280-0100	6
U 10	4
U 27	4
U 19	2
Bracing panel 2379 mm	2
Bracing panel 1379 mm	2

COMPOSITIONS OF KITS

TI-U-2.0 2 / 2

U WH46

Width: 4080 mm, Height: 6125 mm

U 350-0400	6
U 100-3000oZ	8
U 120-3000oZ	4
U 200-1920	12
U 280-0100	9
U 10	6
U 27	6
U 19	3
U 13	3
Bracing panel 2879 mm	6

U WH66

Width: 6080 mm, Height: 6125 mm

U 350-0400	8
U 100-3000oZ	8
U 120-3000oZ	8
U 200-1920	18
U 280-0100	12
U 10	8
U 27	8
U 19	4
U 13	8
Bracing panel 2879 mm	8

U WH45

Width: 4080 mm, Height: 5125 mm

U 350-0400	6
U 100-2500oZ	8
U 120-2500oZ	4
U 200-1920	12
U 280-0100	9
U 10	6
U 27	6
U 19	3
Bracing panel 2379 mm	6

U WH65

Width: 6080 mm, Height: 5125 mm

U 350-0400	8
U 100-2500oZ	8
U 120-2500oZ	8
U 200-1920	18
U 280-0100	12
U 10	8
U 27	8
U 19	4
Bracing panel 2379 mm	8

U WH44

Width: 4080 mm, Height: 4125 mm

U 350-0400	6
U 100-1500oZ	4
U 100-2500oZ	4
U 120-1500oZ	2
U 120-2500oZ	2
U 200-1920	12
U 280-0100	9
U 10	6
U 27	6
U 19	3
Bracing panel 2379 mm	3
Bracing panel 1379 mm	3

U WH64

Width: 6080 mm, Height: 4125 mm

U 350-0400	8
U 100-1500oZ	4
U 100-2500oZ	4
U 120-1500oZ	4
U 120-2500oZ	4
U 200-1920	18
U 280-0100	12
U 10	8
U 27	8
U 19	4
Bracing panel 2379 mm	4
Bracing panel 1379 mm	4

! Attention!
Bracing panel is not included in kit.
See technical information TI-U-010

TI-U-2.0

COMPOSITIONS OF KITS VARIABLE

TI-U-2.1 1 / 2

TECHNICAL INFORMATION

U WH16V

Width: 720-960 mm, Height: 6125 mm

U 350-0400	4
U 100-3000oZ	8
U 210-0560	6
U 280-0100	6
U 10	4
U 27	4
U 19	2
Bracing panel 2879 mm	4

U WH15V

Width: 720-960 mm, Height: 5125 mm

U 350-0400	4
U 100-2500oZ	8
U 210-0560	6
U 280-0100	6
U 10	4
U 27	4
U 19	2
Bracing panel 2379 mm	4

U WH14V

Width: 720-960 mm, Height: 4125 mm

U 350-0400	4
U 100-1500oZ	4
U 100-2500oZ	4
U 210-0560	6
U 280-0100	6
U 10	4
U 27	4
U 19	2
Bracing panel 2379 mm	2
Bracing panel 1379 mm	2

! Attention!
Bracing panel is not
included in kit.
See technical
information TI-U-010

U WH26V

Width: 1280-2080 mm, Height: 6125 mm

U 350-0400	4
U 100-3000oZ	8
U 210-1120	6
U 280-0100	6
U 10	4
U 27	4
U 19	2
Bracing panel 2879 mm	4

U WH25V

Width: 1280-2080 mm, Height: 5125 mm

U 350-0400	4
U 100-2500oZ	8
U 210-1120	6
U 280-0100	6
U 10	4
U 27	4
U 19	2
Bracing panel 2379 mm	4

U WH24V

Width: 1280-2080 mm, Height: 4125 mm

U 350-0400	4
U 100-1500oZ	4
U 100-2500oZ	4
U 210-1120	6
U 280-0100	6
U 10	4
U 27	4
U 19	2
Bracing panel 2379 mm	2
Bracing panel 1379 mm	2

TI-U-2.1

COMPOSITIONS OF KITS VARIABLE

TI-U-2.1 2 / 2

U WH46V

Width: 2480-4080 mm, Height: 6125 mm

U 350-0400	6
U 100-3000oZ	8
U 120-3000oZ	4
U 210-1120	12
U 280-0100	9
U 10	6
U 27	6
U 19	3
U 13	3
Bracing panel 2879 mm	6

U WH66V

Width: 4480-6080 mm, Height: 6125 mm

U 350-0400	8
U 100-3000oZ	8
U 120-3000oZ	8
U 200-1920	6
U 210-1120	12
U 280-0100	12
U 10	8
U 27	8
U 19	4
U 13	8
Bracing panel 2879 mm	8

U WH45V

Width: 2480-4080 mm, Height: 5125 mm

U 350-0400	6
U 100-2500oZ	8
U 120-2500oZ	4
U 210-1120	12
U 280-0100	9
U 10	6
U 27	6
U 19	3
Bracing panel 2379 mm	6

U WH65V

Width: 4480-6080 mm, Height: 5125 mm

U 350-0400	8
U 100-2500oZ	8
U 120-2500oZ	8
U 200-1920	6
U 210-1120	12
U 280-0100	12
U 10	8
U 27	8
U 19	4
Bracing panel 2379 mm	8

U WH44V

Width: 2480- 4080 mm, Height: 4125 mm

U 350-0400	6
U 100-1500oZ	4
U 100-2500oZ	4
U 120-1500oZ	2
U 120-2500oZ	2
U 210-1120	12
U 280-0100	9
U 10	6
U 27	6
U 19	3
Bracing panel 2379 mm	3
Bracing panel 1379 mm	3

U WH64V

Width: 4480-6080 mm, Height: 4125 mm

U 350-0400	8
U 100-1500oZ	4
U 100-2500oZ	4
U 120-1500oZ	4
U 120-2500oZ	4
U 200-1920	6
U 210-1120	12
U 280-0100	12
U 10	8
U 27	8
U 19	4
Bracing panel 2379 mm	4
Bracing panel 1379 mm	4

! Attention!
Bracing panel is not included in kit.
See technical information TI-U-010

TI-U-2.1

height 6 m - width 2 m

4 × U10

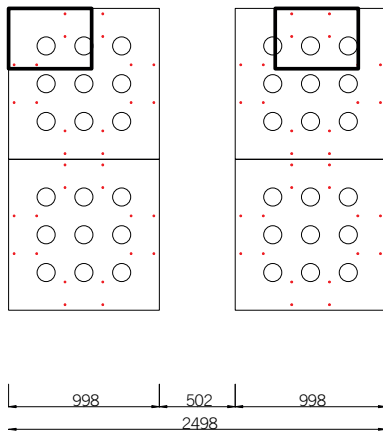

height 4 m - width 2 m

4 × U10

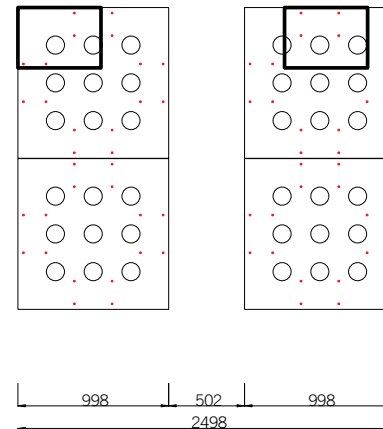

height 5 m - width 2 m

4 × U10

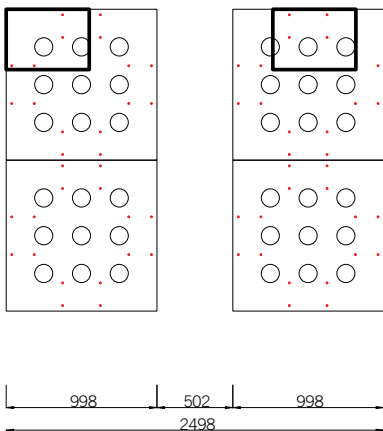

height 3 m - width 2 m

2 × U10

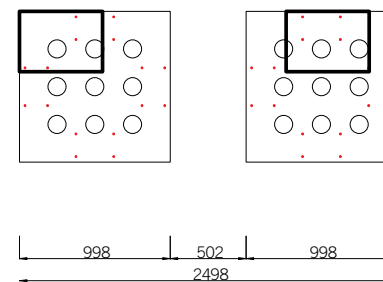

TI-U-4.0

FLOOR BALLASTING 2 METERS - MIDDLE

TI-U-4.1

height 6 m - width 2 m

4 × U10

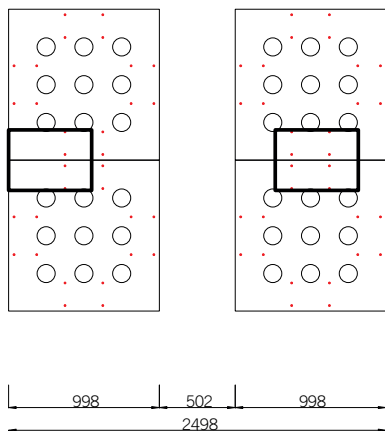

height 4 m - width 2 m

2 × U10

4 × U13

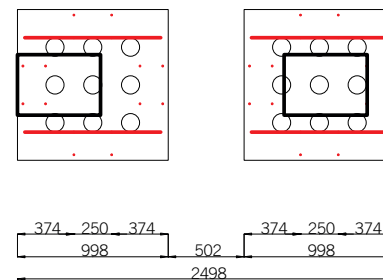

height 5 m - width 2 m

4 × U10

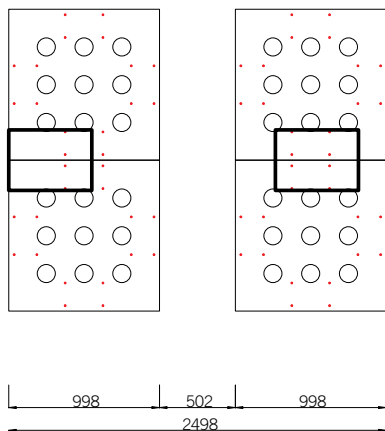

height 3 m - width 2 m

2 × U10

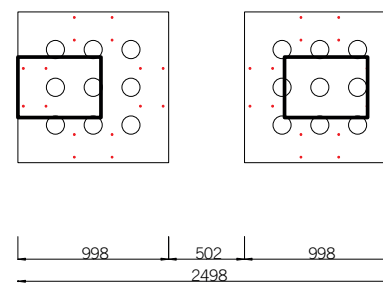

TI-U-4.1

height 6 m - width 4 m

6 × U10
3 × U13

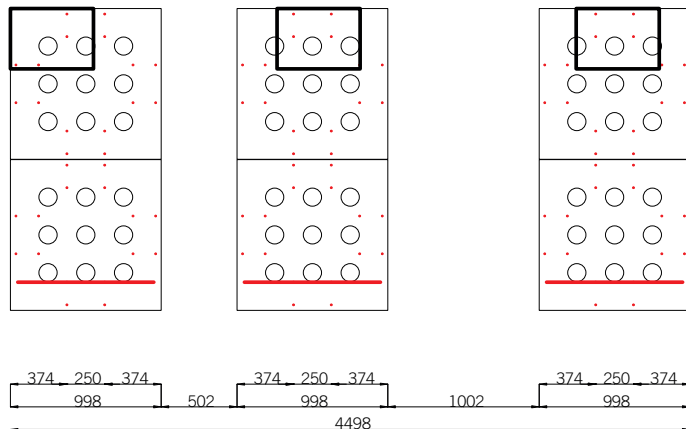

height 4 m - width 4 m

6 × U10

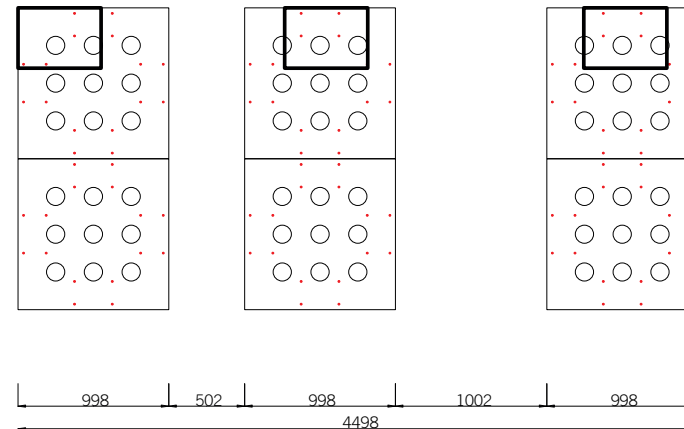

height 5 m - width 4 m

6 × U10

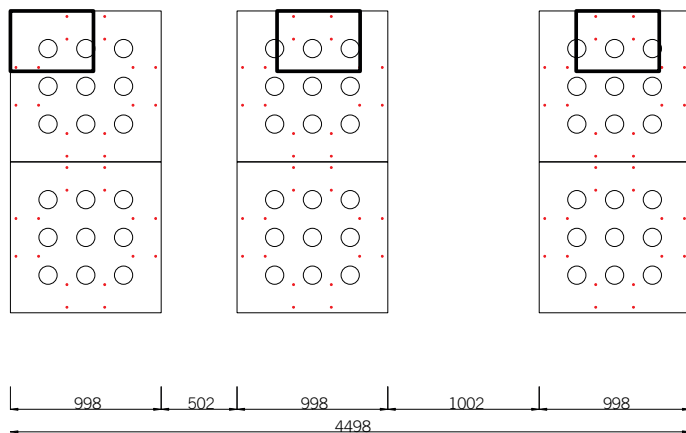

height 3 m - width 4 m

3 × U10
3 × U13

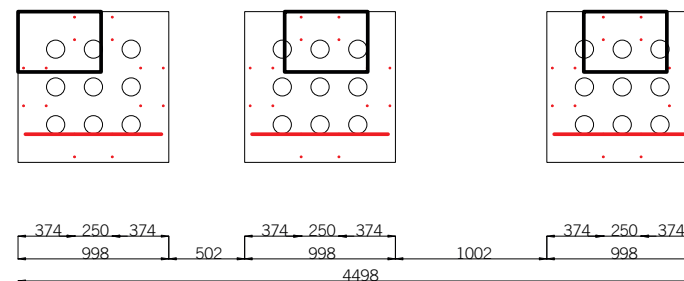

TI-U-4.2

FLOOR BALLASTING 4 METERS - MIDDLE

TI-U-4.3

Height 6 M - Width 4 M

6 × U10
6 × U13

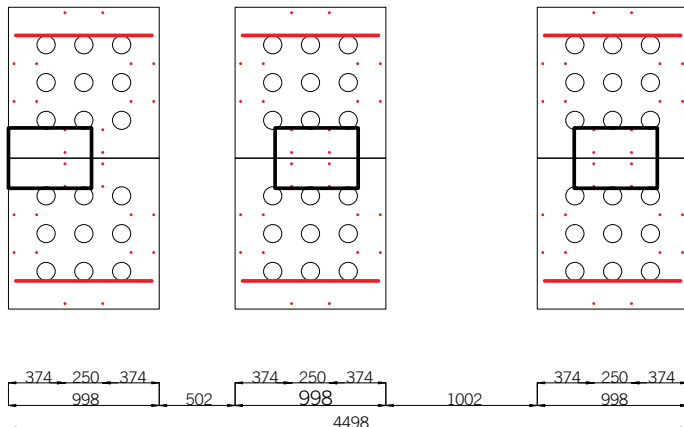

Height 4 M - Width 4 M

6 × U10

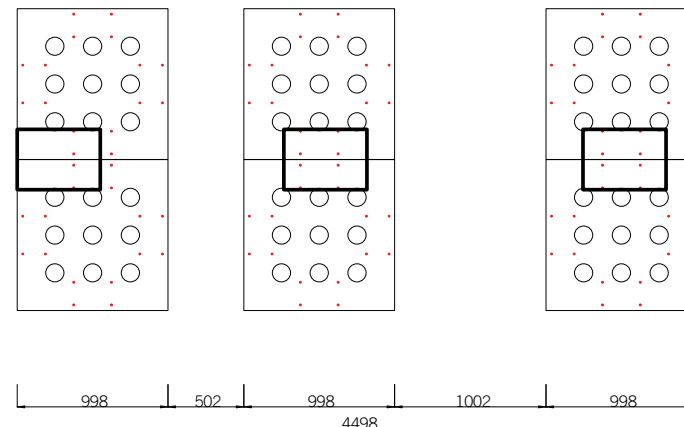

Height 5 M - Width 4 M

6 × U10

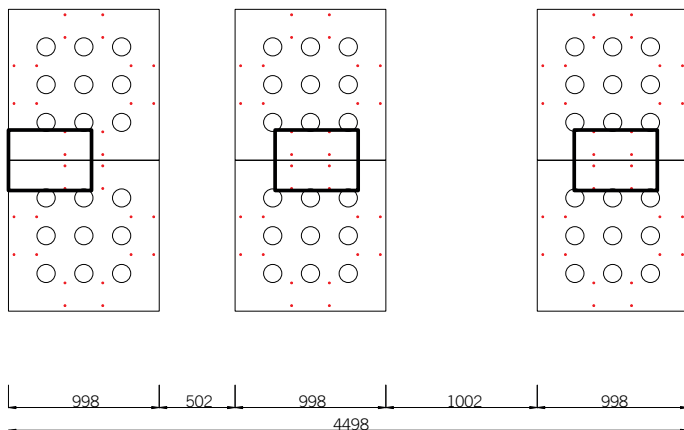

Height 3 M - Width 4 M

3 × U10
3 × U13

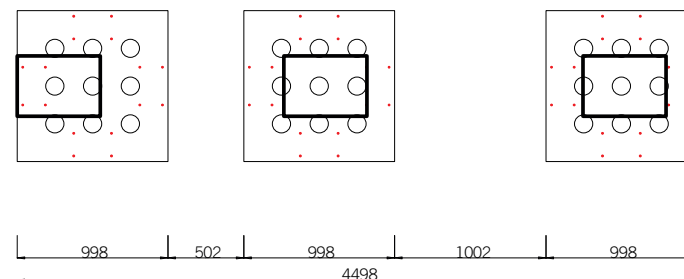

TI-U-4.3

height 6 m - width 6 m

8 × U10
8 × U13

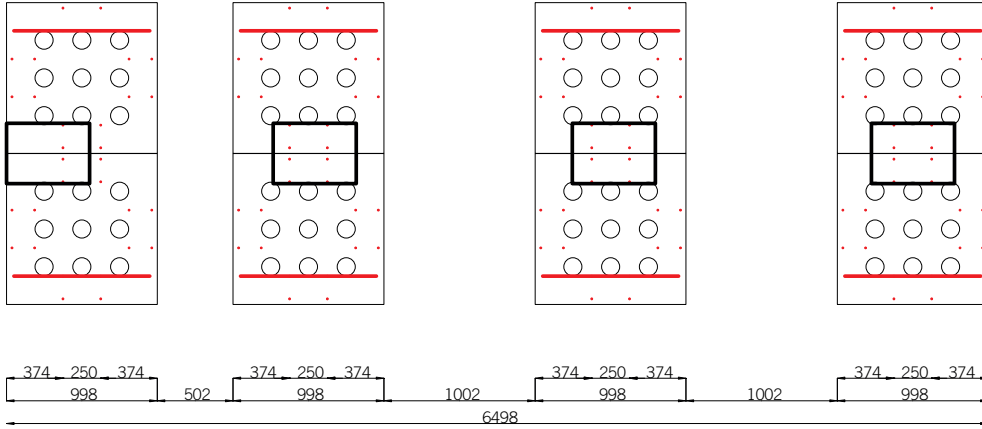

height 4 m - width 6 m

8 × U10

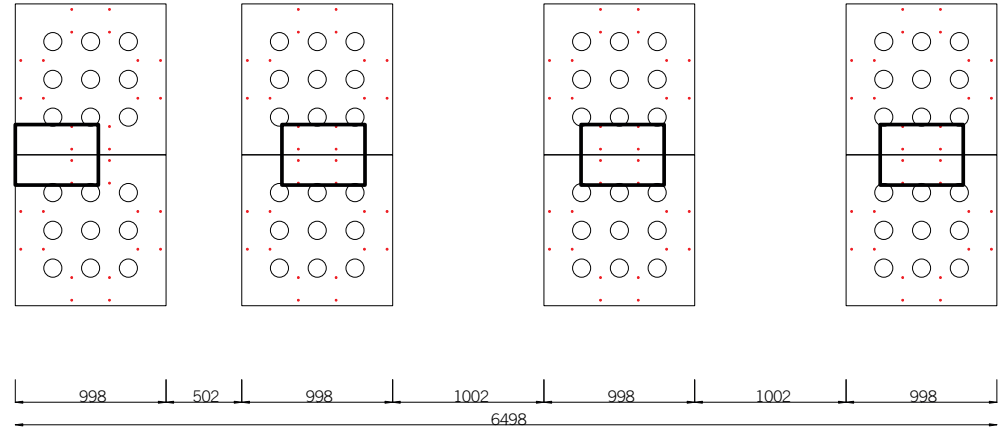

height 5 m - width 6 m

8 × U10

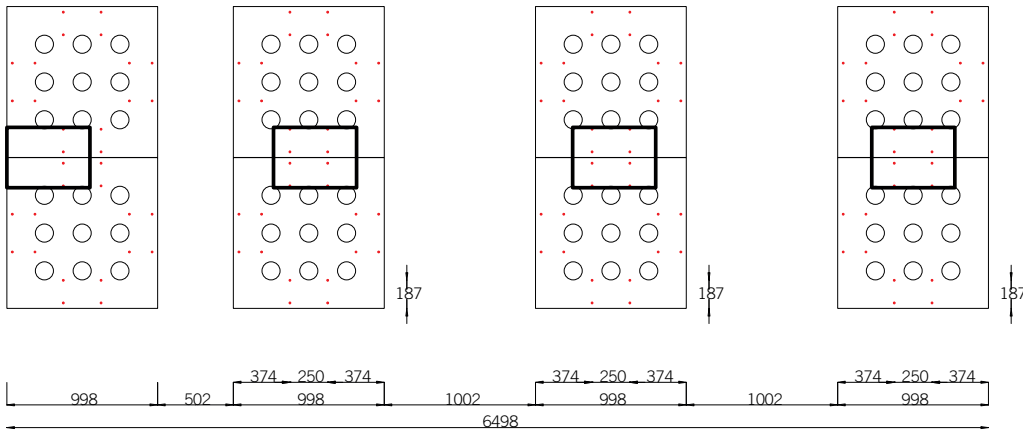

height 3 m - width 6 m

4 × U10
6 × U13

ANz. U13 - 6 Stk

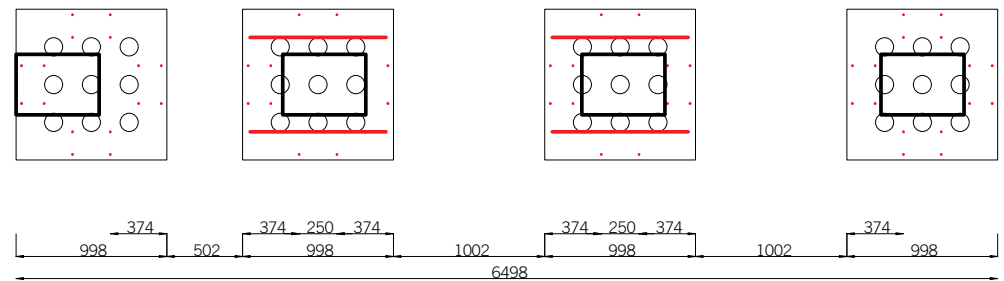

TI-U-4.5

DRILLING PATTERN FOR MOUNTING PANEL TYPE A

TI-U-A

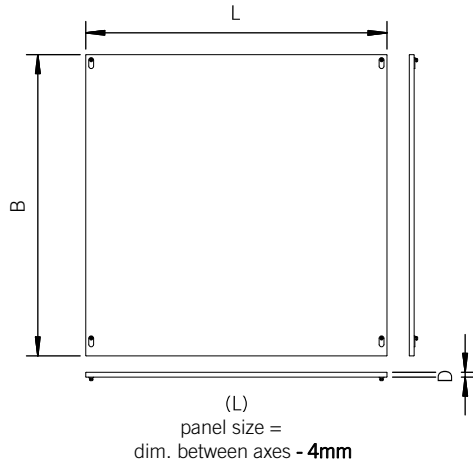

DRILLING INFORMATION

drillings: \varnothing 10mm, depth: 13,5 mm

drillings: \varnothing 5mm, depth: 8 mm

Mount threaded insert OC 2880 and mounting screw U 495 to drillings with \varnothing 10mm

horizontal groove = 4mm

vertical groove = 4mm

parts list		
Quantity	Article No.	Description
4	OC 2880	threaded insert M8
4	U 495	mounting screw

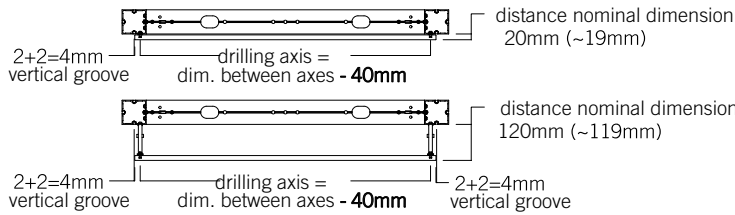
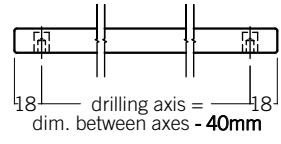
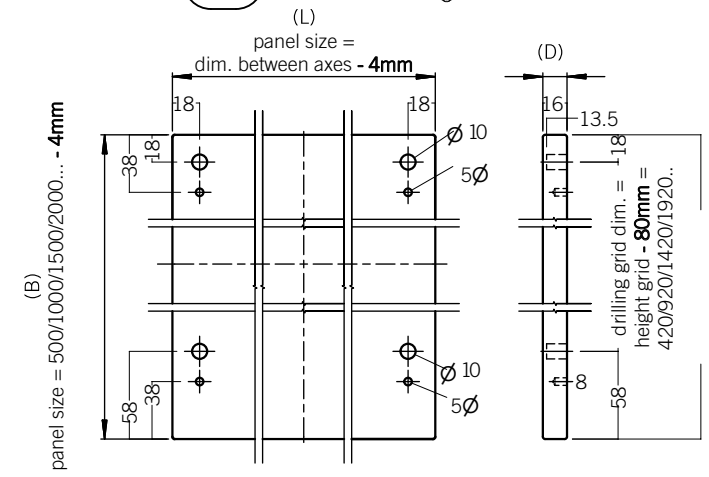
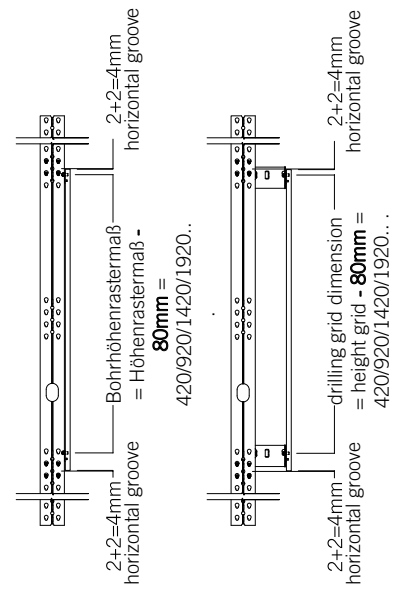
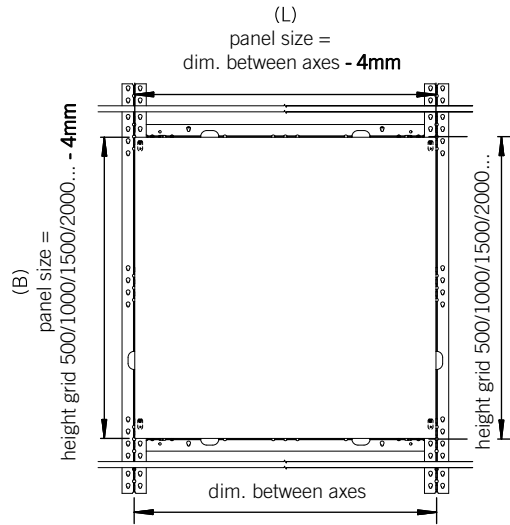
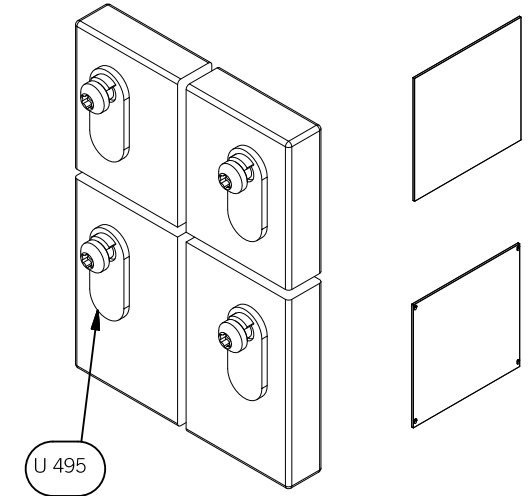

496/996/1496/1996...
TIUA.D E-000606-2010A-T00 A

DRILLING PATTERN FOR MOUNTING PANEL TYPE B-L20 LEFT

TI-U-BL020

TECHNICAL INFORMATION

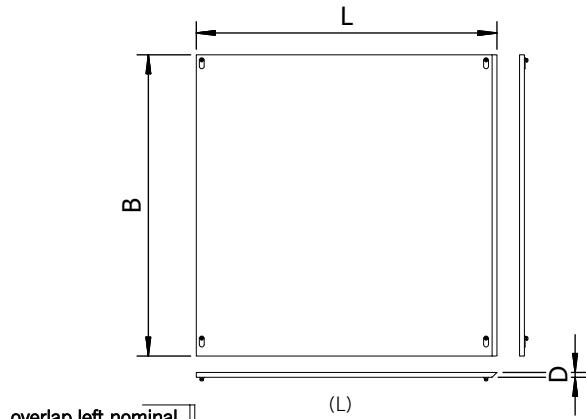

DRILLING INFORMATION

drillings: \varnothing 10mm, depth: 13,5 mm

drillings: \varnothing 5mm, depth: 8 mm

Mount threaded insert OC 2880 and mounting screw U 495 to drillings with \varnothing 10mm.
 horizontal groove = 4mm
 vertical groove = 4mm
 vertical groove miter = ~4mm

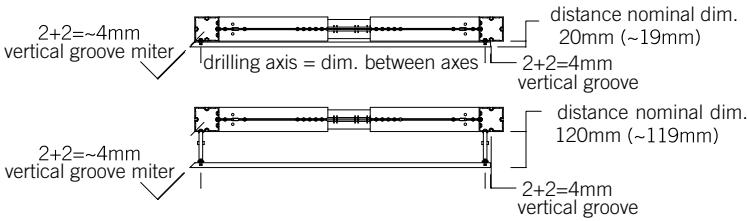
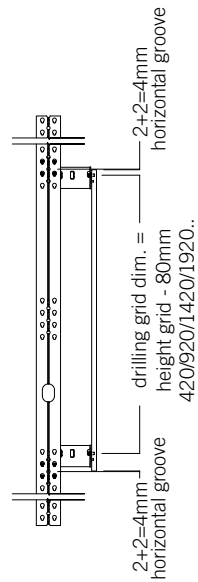
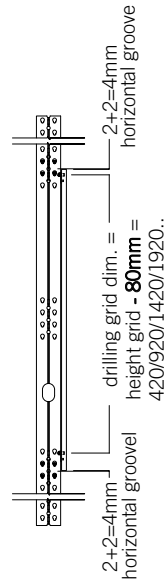
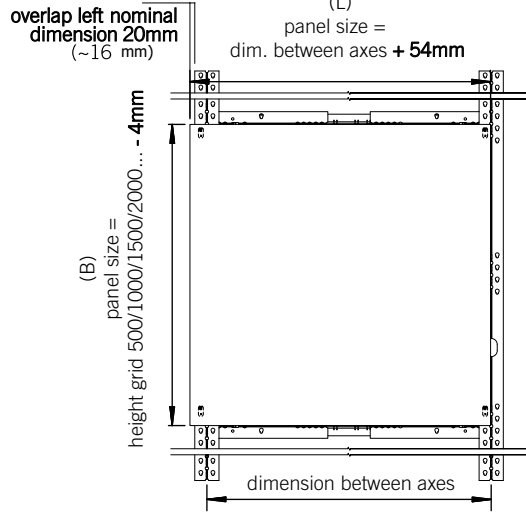

parts list		
Quantity	Article No.	Description
4	OC 2880	threaded insert M8
4	U 495	mounting screw

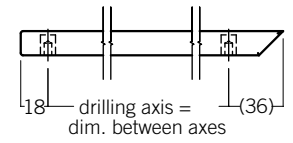
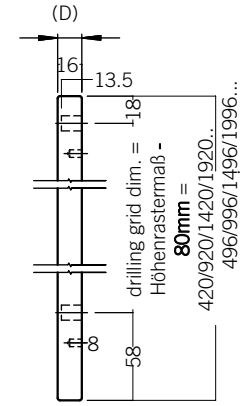
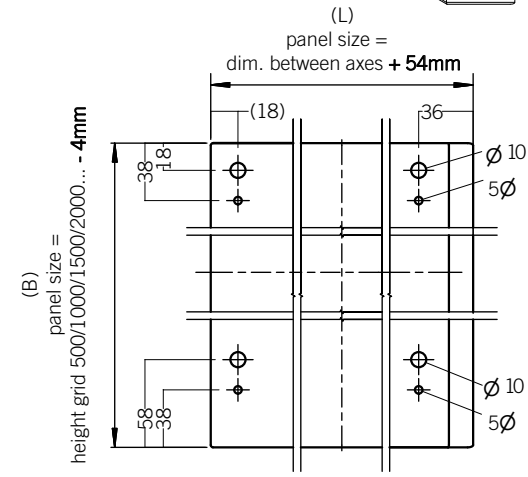
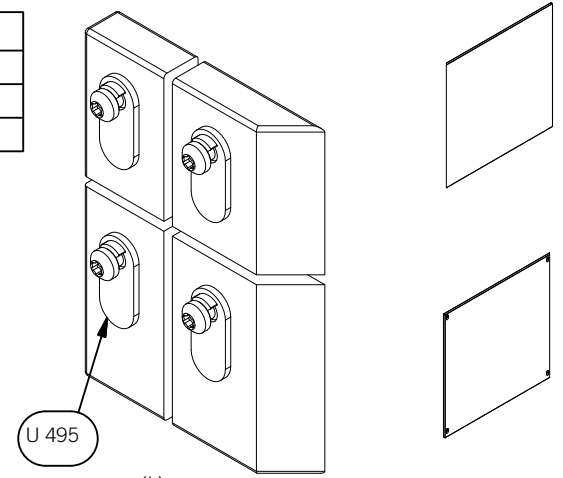

TIUBL020.D E-000606-2012A-T00 A

DRILLING PATTERN FOR MOUNTING PANEL TYPE B-L 120 LEFT

TI-U-BL120

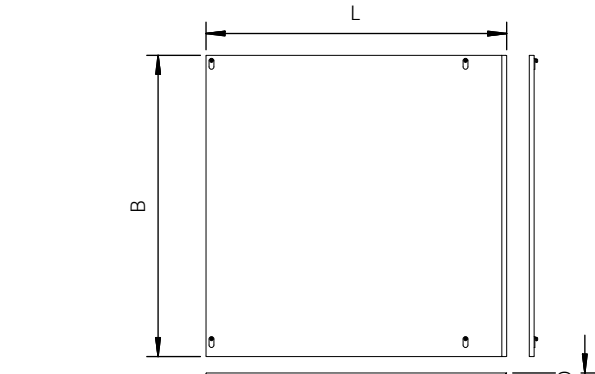

DRILLING INFORMATION

drillings: \varnothing 10mm, depth: 13,5 mm

drillings: \varnothing 5mm, depth: 8 mm

Mount threaded insert OC 2880 and mounting screw U 495 to drilling with \varnothing 10 mm

horizontal groove = 4mm
vertical groove = 4mm
vertical groove miter = -4mm

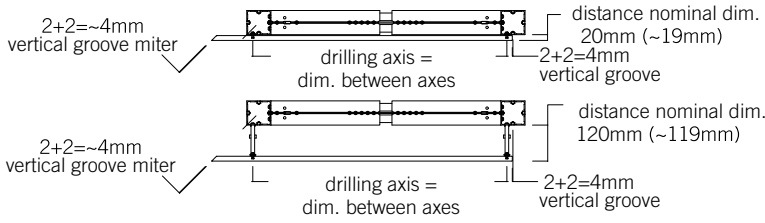
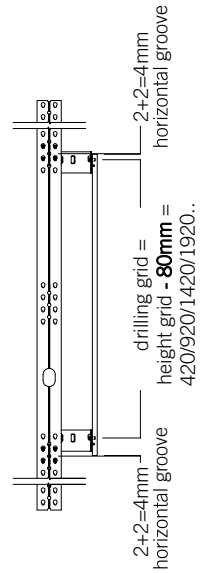
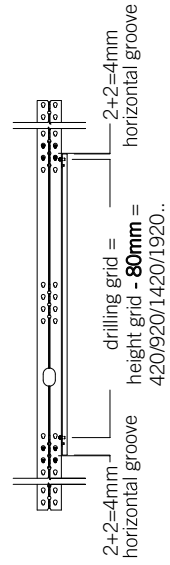
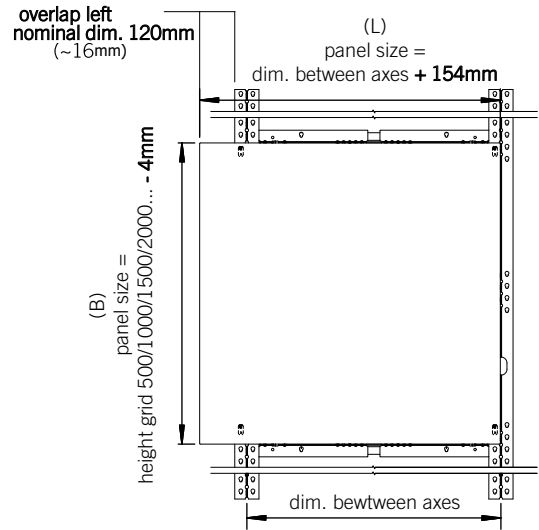

parts list		
Quantity	Article No.	Description
4	OC 2880	threaded insert M8
4	U 495	mounting screw

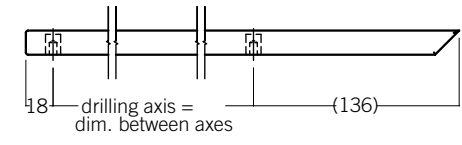
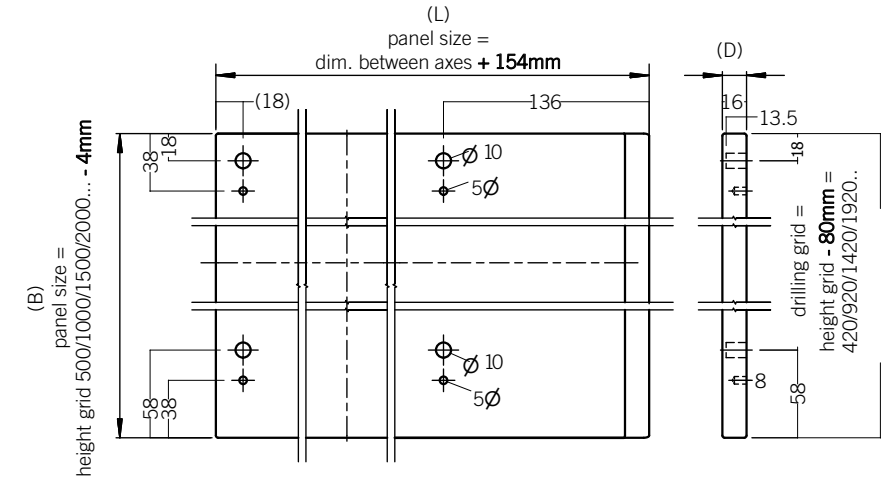
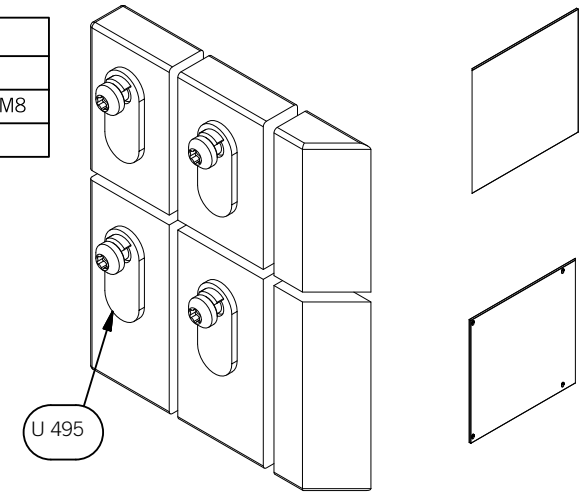

496/996/1496/1996...
TTUBL120.D E-000606-2016A-T00 A

DRILLING PATTERN FOR MOUNTING PANEL TYPE B-R20 RIGHT

TI-U-BR020

TECHNICAL INFORMATION

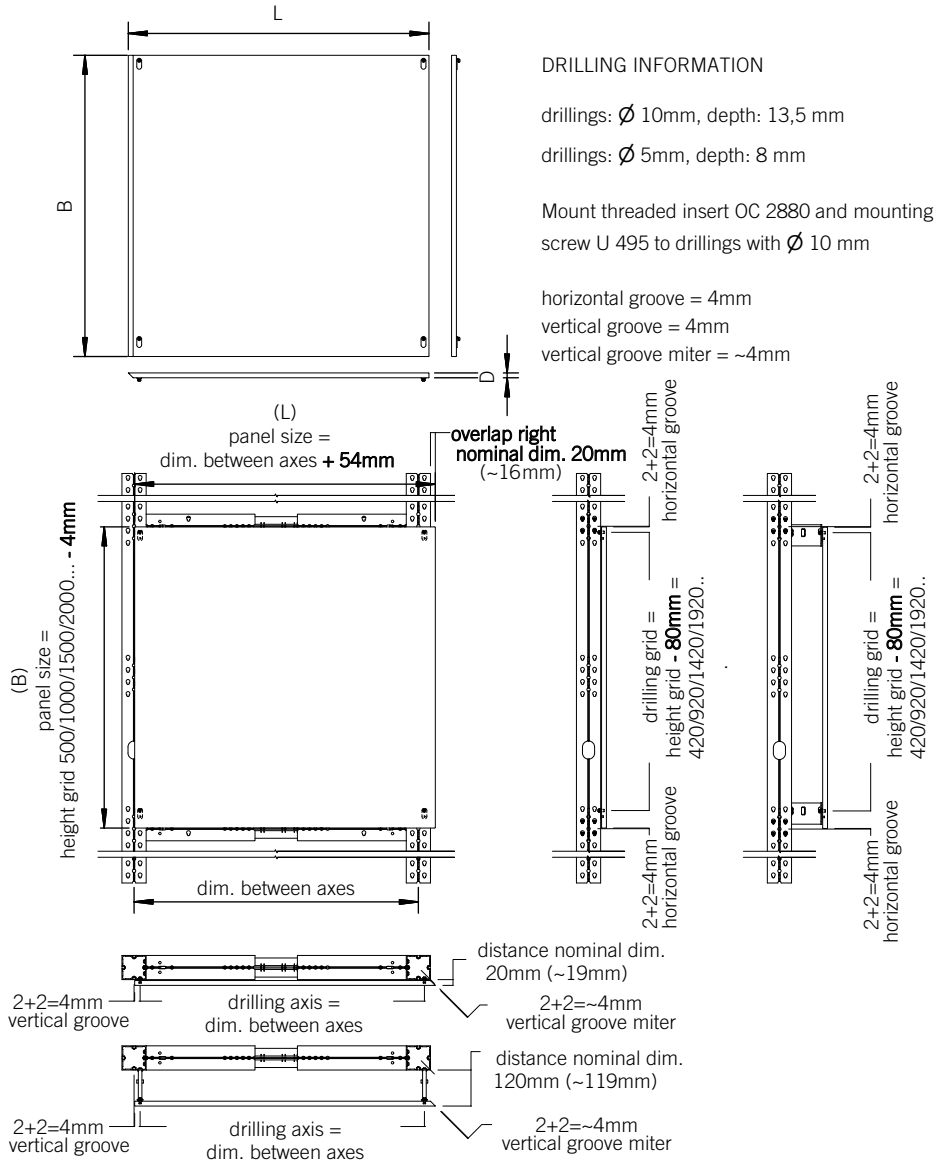

parts list		
Quantity	Article No.	Description
4	OC 2880	threaded insert M8
4	U 495	mounting screw

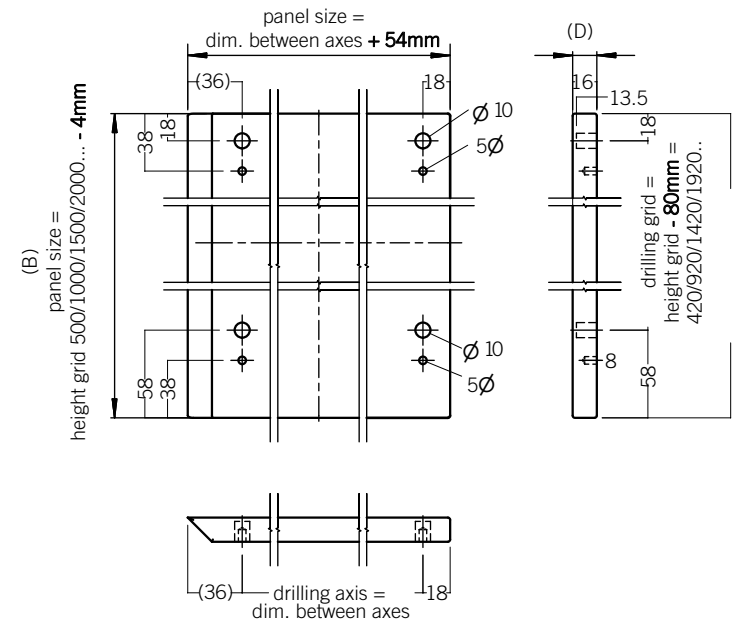
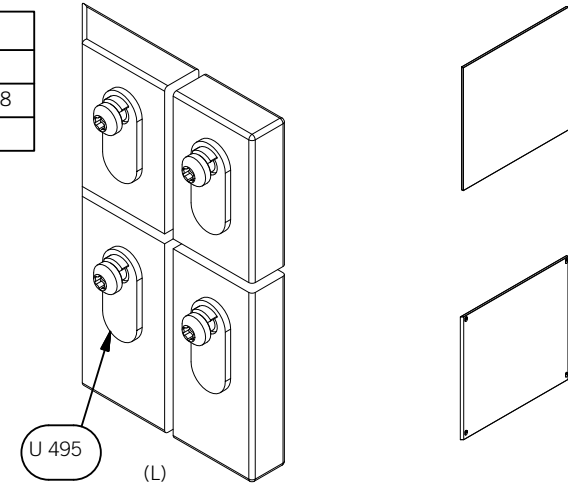

496/996/1496/1996...

TIUBR020.D E-000606-2011A-T00 A

EXAMPLE CROSS SECTION L-WALL M 1901 DEPTH 120 MM

TI-U-BS-A002

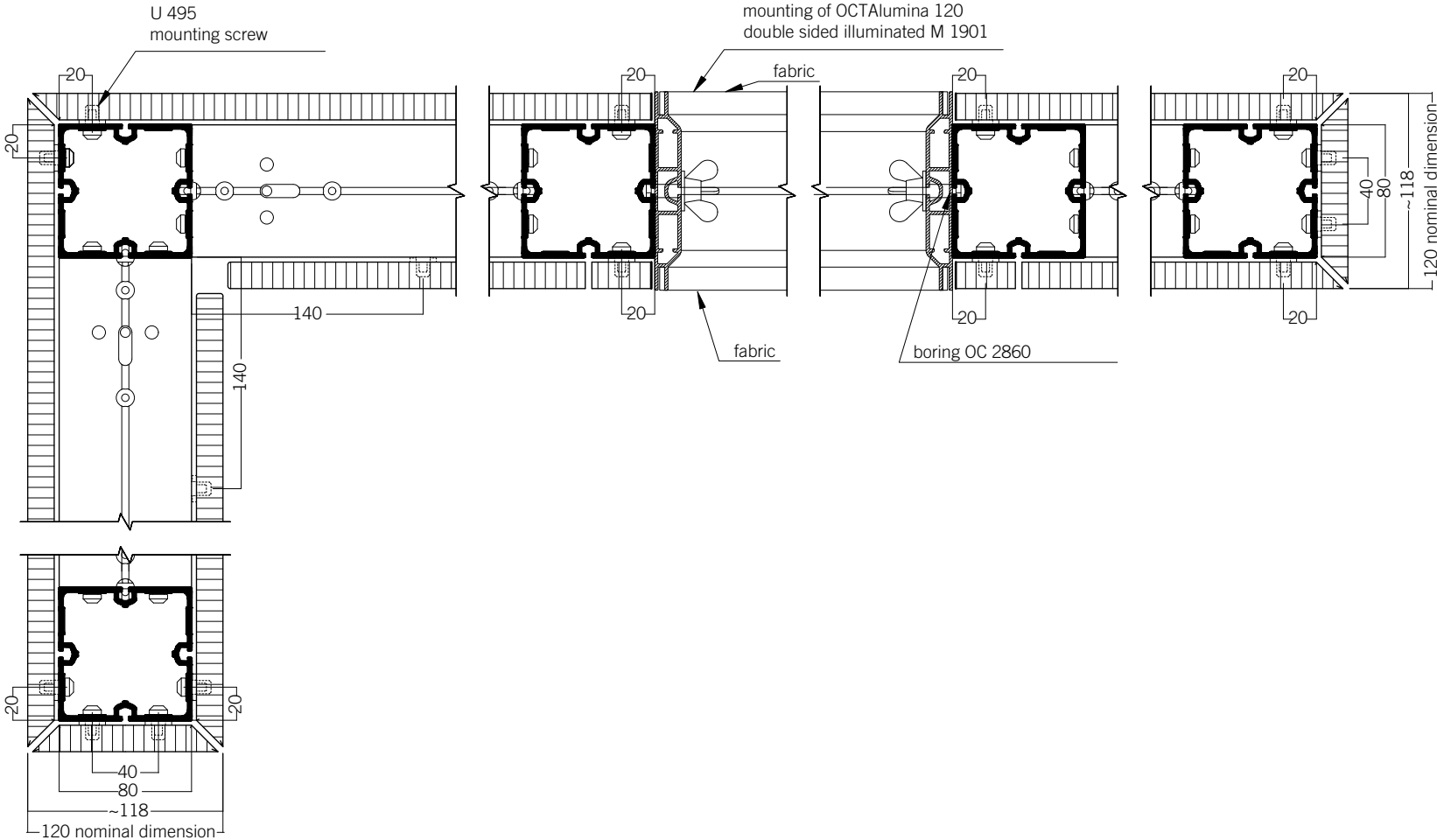

TIU-BS-A002.D E-000604-2801A-T00 A

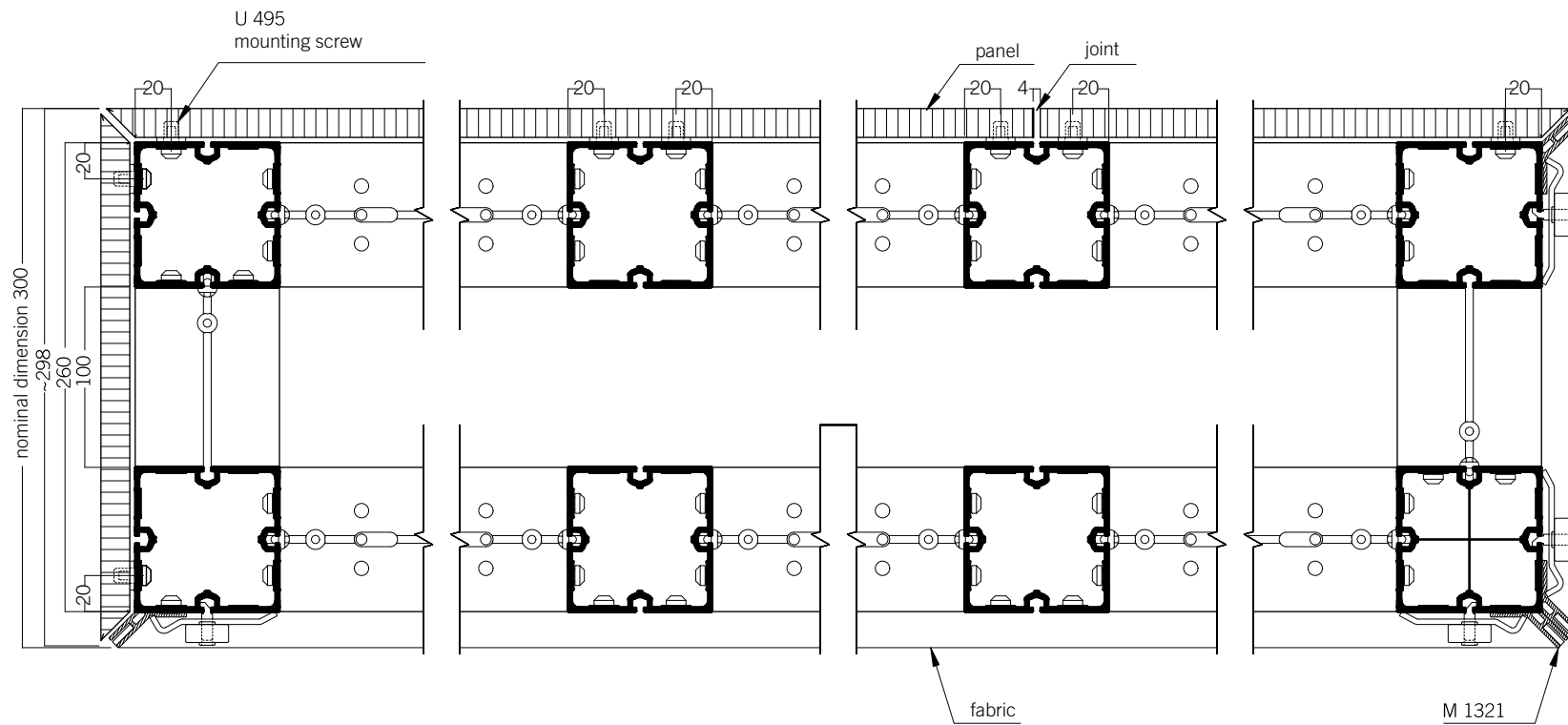

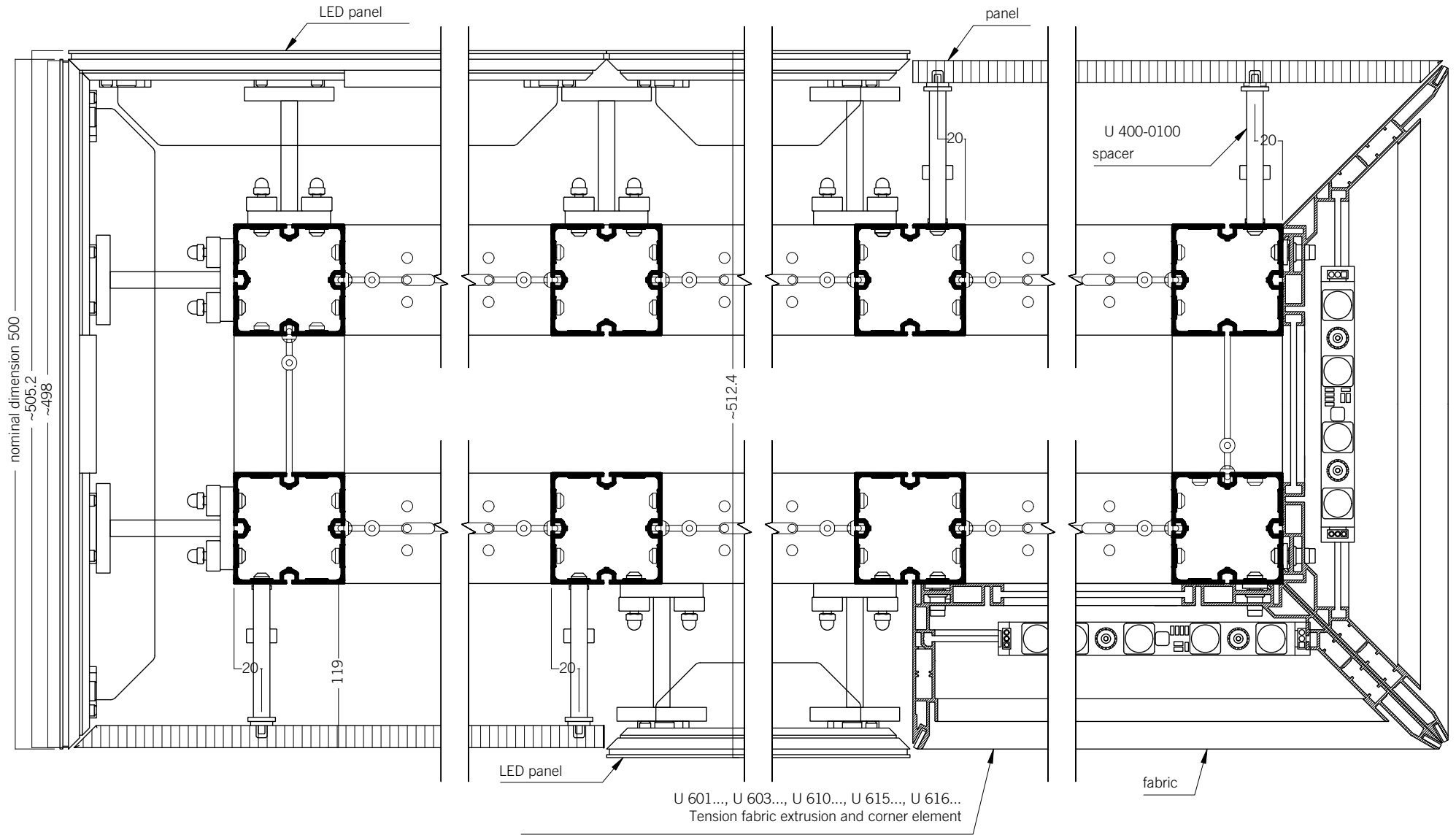

TIU-BS-E001.D E-000604-2800A-T08 A

ARRANGEMENT LED MODULES

TI-U-LED010

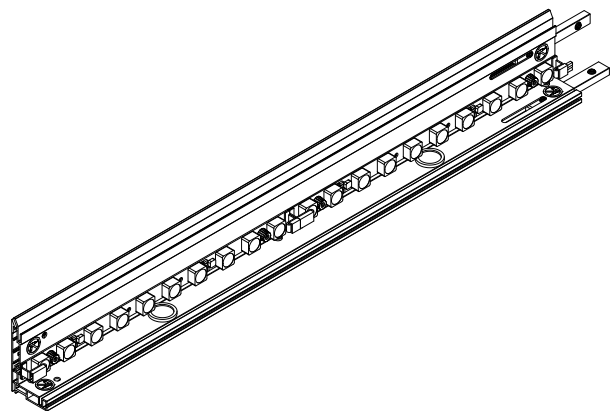

U 1060 / U 601-... (1 : 2)

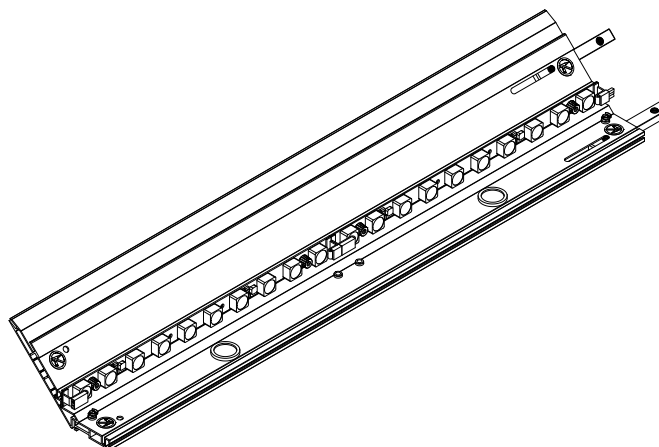
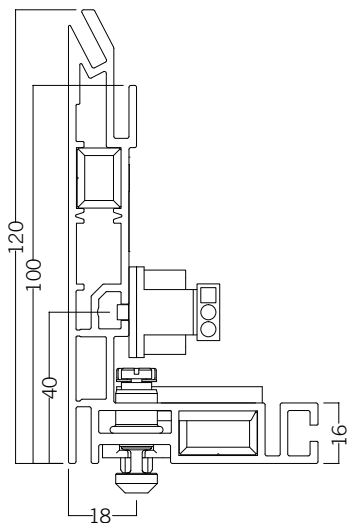

U 1063 / U 603-... (1 : 2)

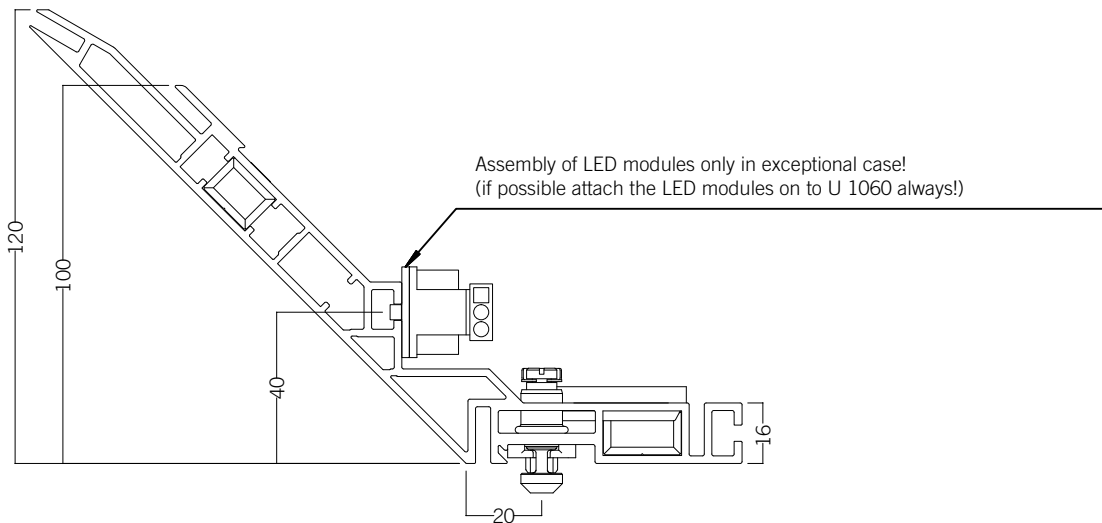

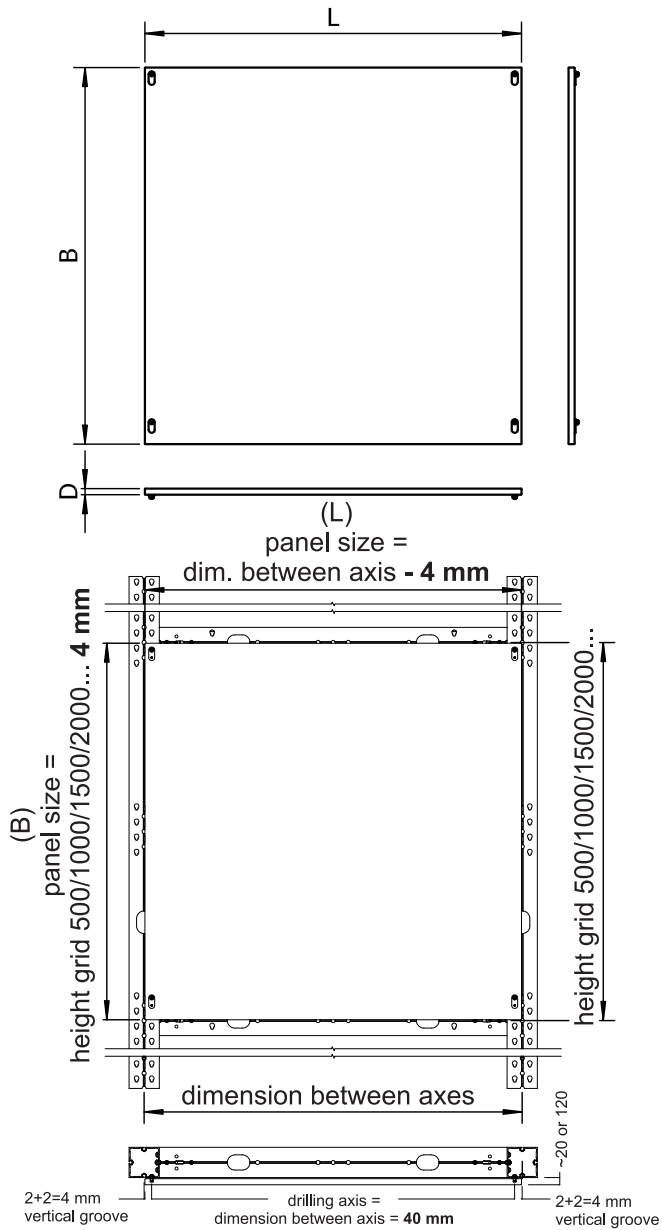

DRILLING INFORMATION

drillings: \varnothing 10 mm, depth: 13,5 mm

drillings \varnothing 5mm, depth: 8 mm

Mount threaded insert OC 2880 and mounting screw U 495 to drillings with \varnothing 10mm

horizontal groove = 4 mm
vertical groove = 4 mm

part list		
Quantity	Article No.	Description
4	OC 2880	threaded insert M8
4	U 495	mounting screw

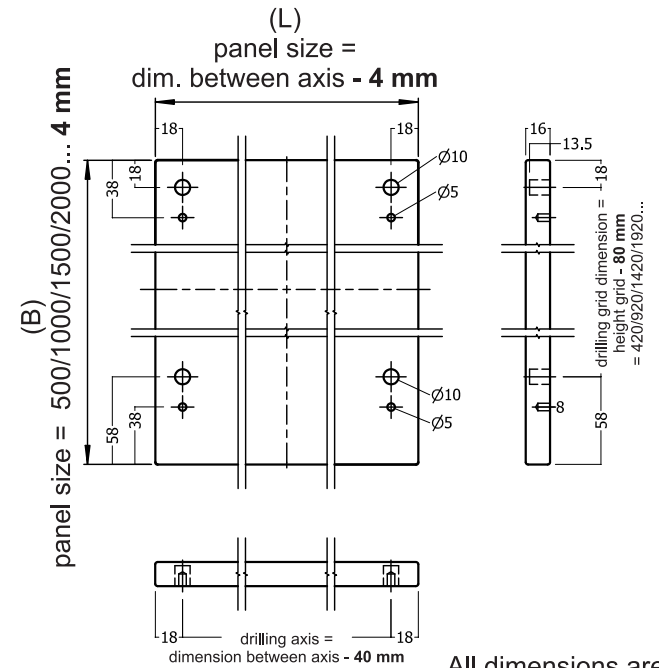
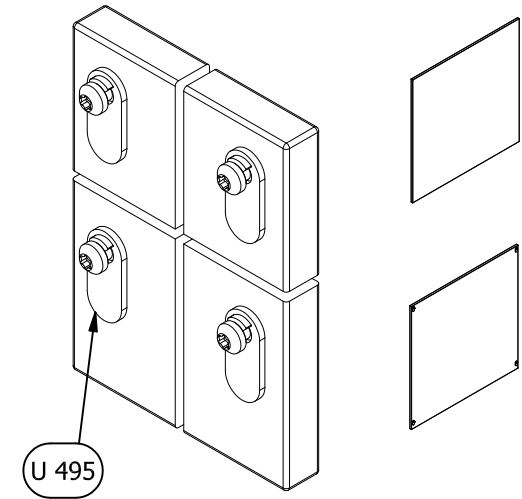

All dimensions are in mm!

U 695 MOUNTING SCREW FOR FRAME ELEMENTS OCTALUMINA PLUS UNIVERSAL

TI-U-S01

1. Loosen spring ring U 695-C.

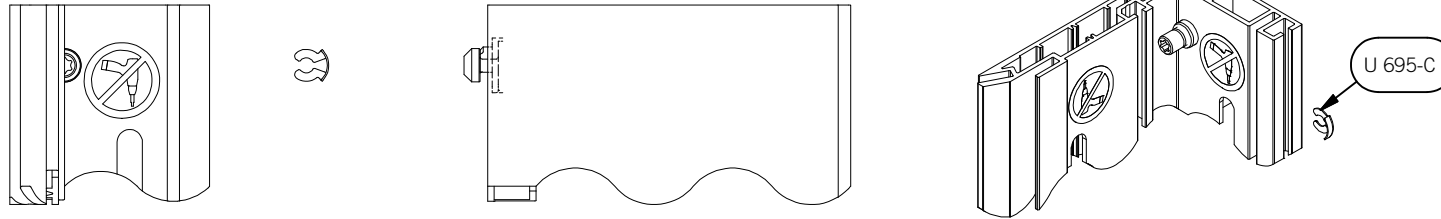

2. Unscrew suspension screw U 695-B up to approx. 5 mm projection. Turn hanging plate U 695-A to desired position in 90° grid.

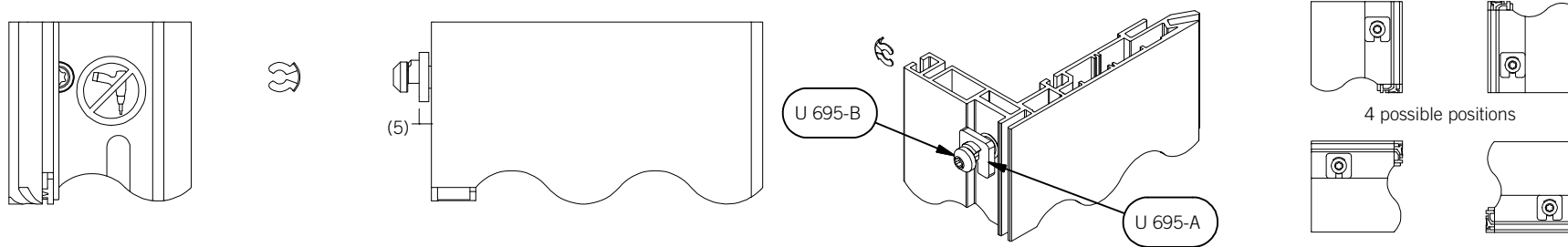

3. Screw in suspension screw U 695-B to approx. 0 mm projection and secure with spring ring U 695-C.

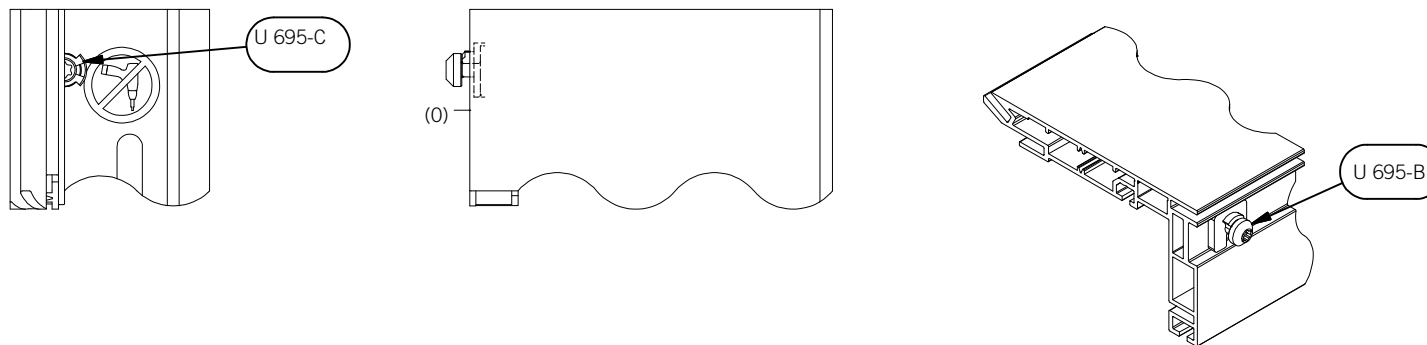

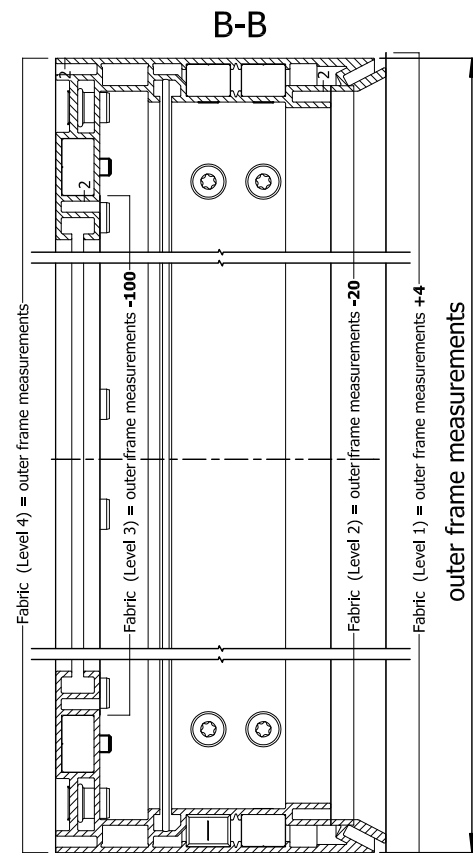
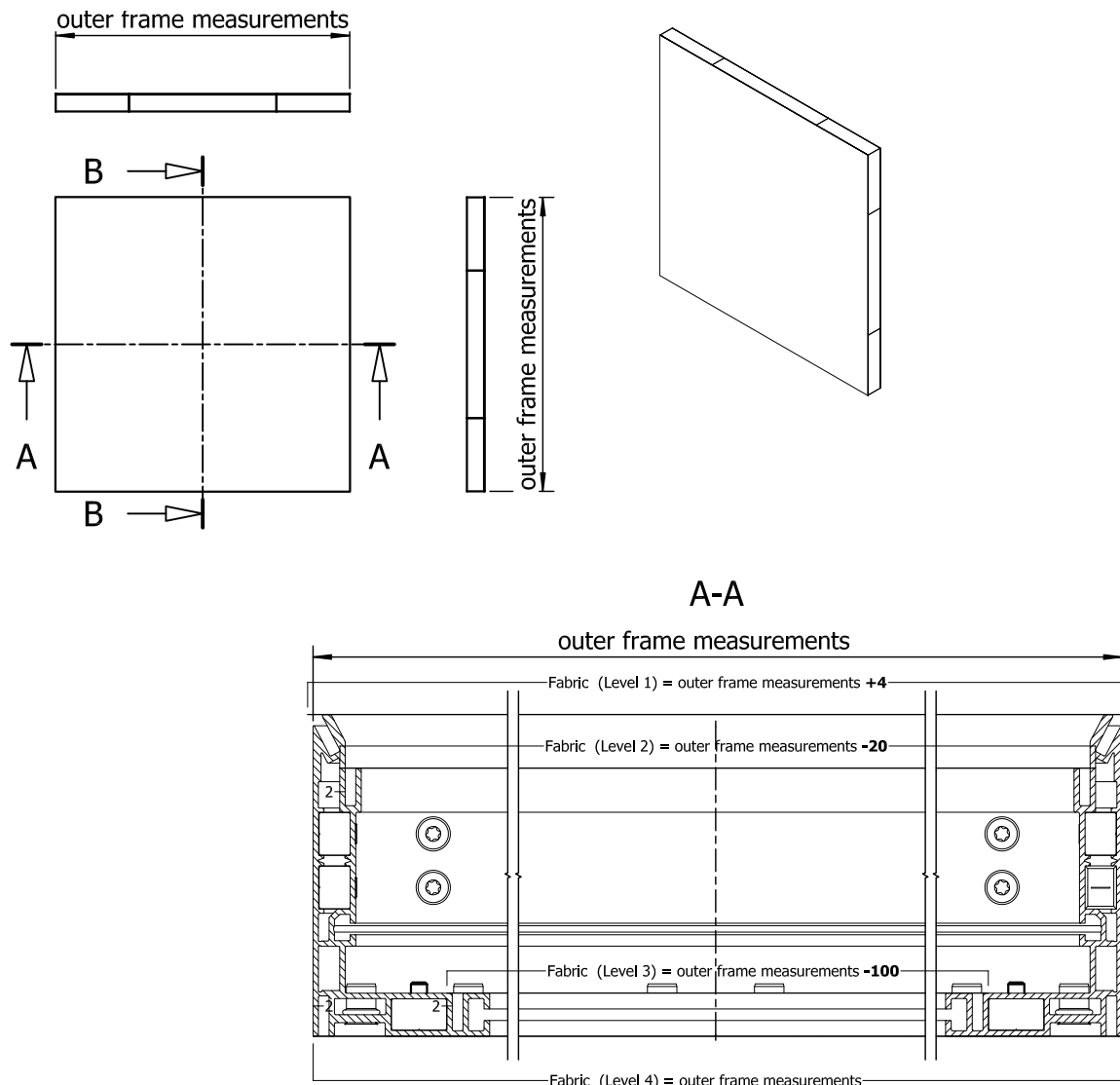

IMPORTANT:

We recommend to only use elastic fabrics.

Always do a test run first and try to mount the fabric to a frame!

EXPLODED DRAWING FRAME ELEMENT OCTALUMINA PLUS UNIVERSAL TYPE A

TI-U-S30.1

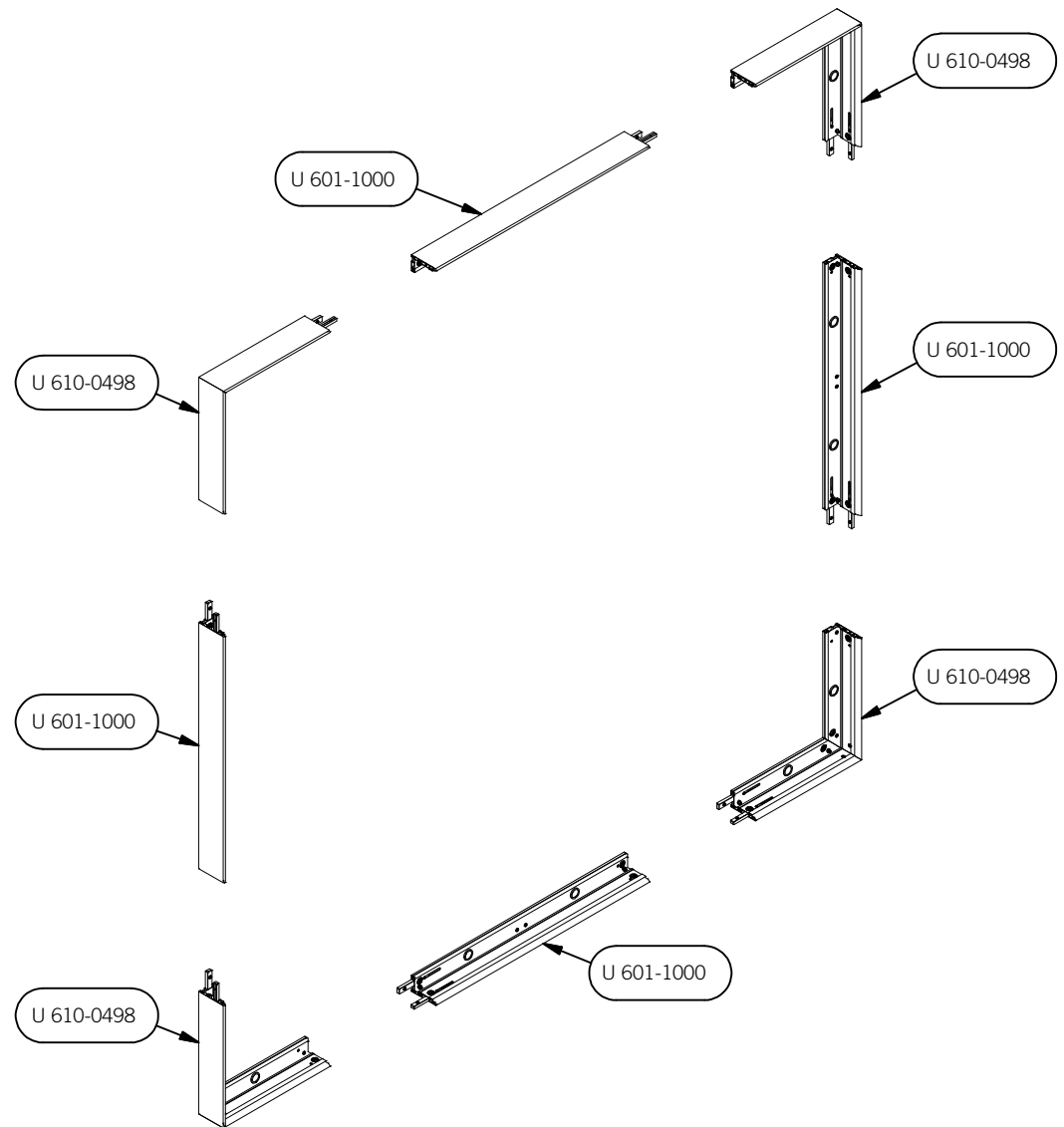
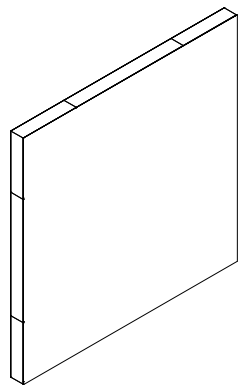
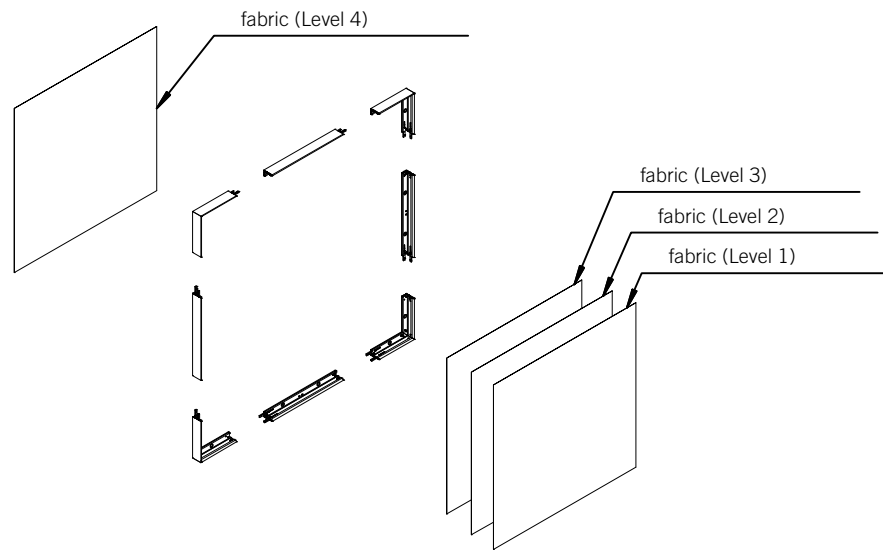

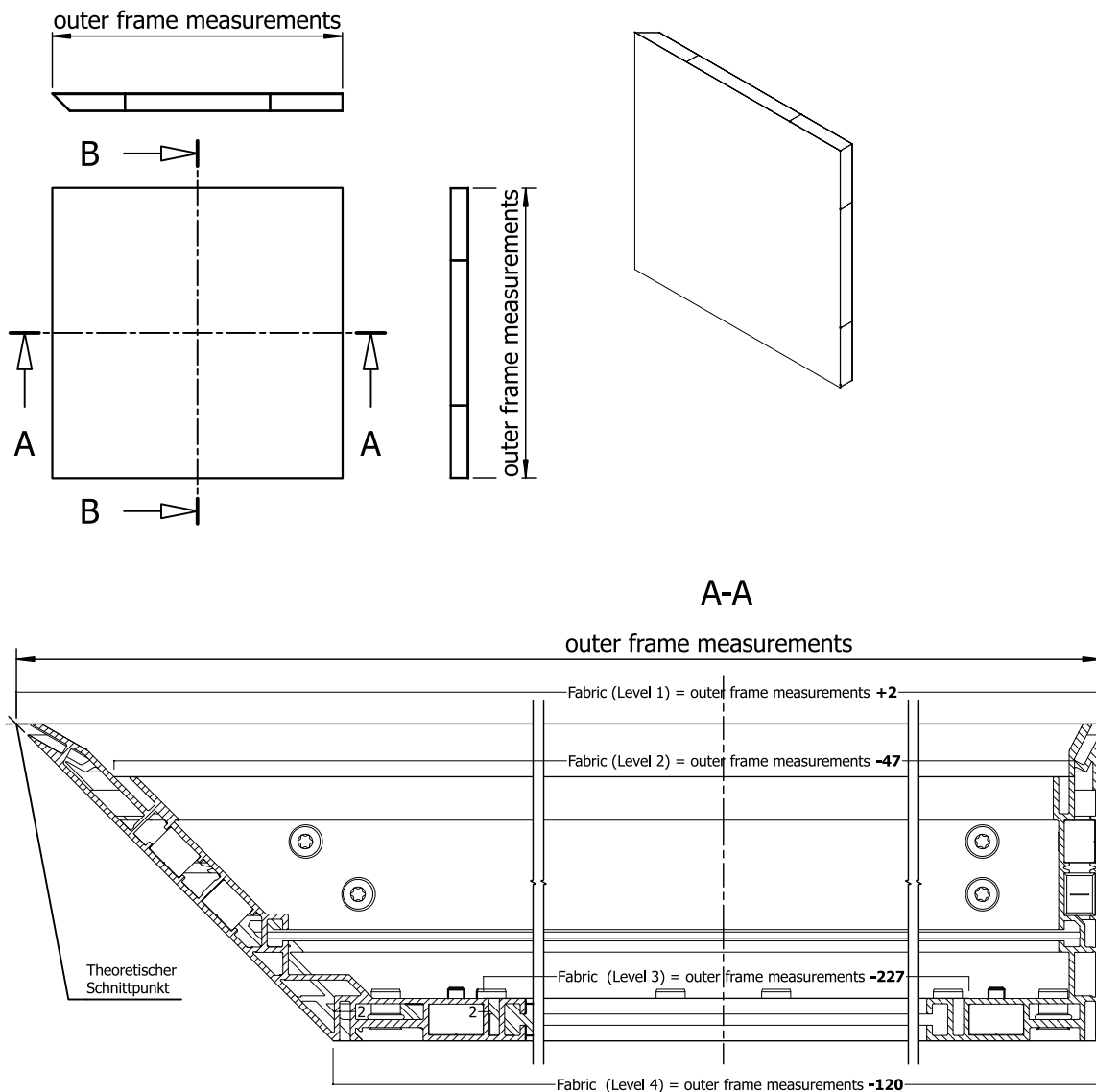

IMPORTANT:

We recommend to only use elastic fabrics.

Always do a test run first and try to mount the fabric to a frame!

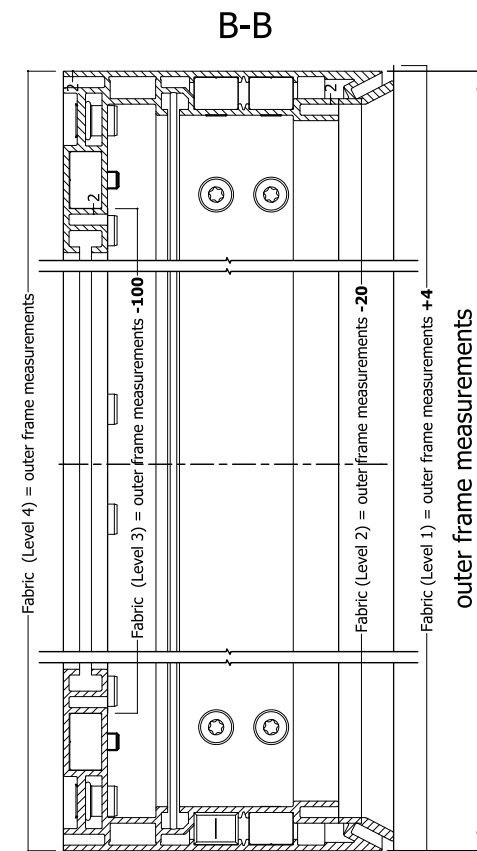

EXPLODED DRAWING FRAME ELEMENT OCTALUMINA PLUS UNIVERSAL TYPE B

TI-U-S31.1

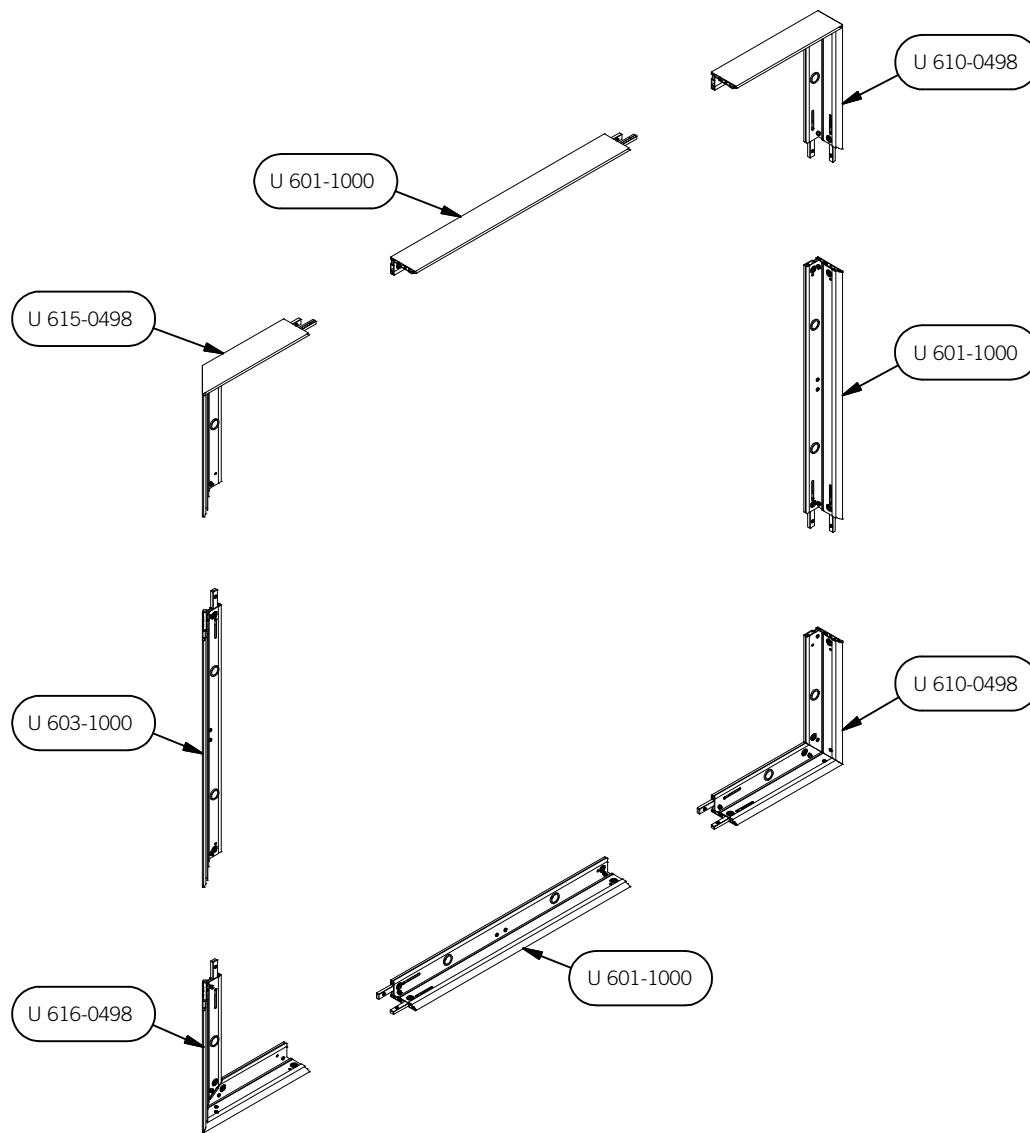
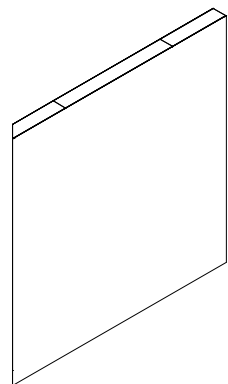
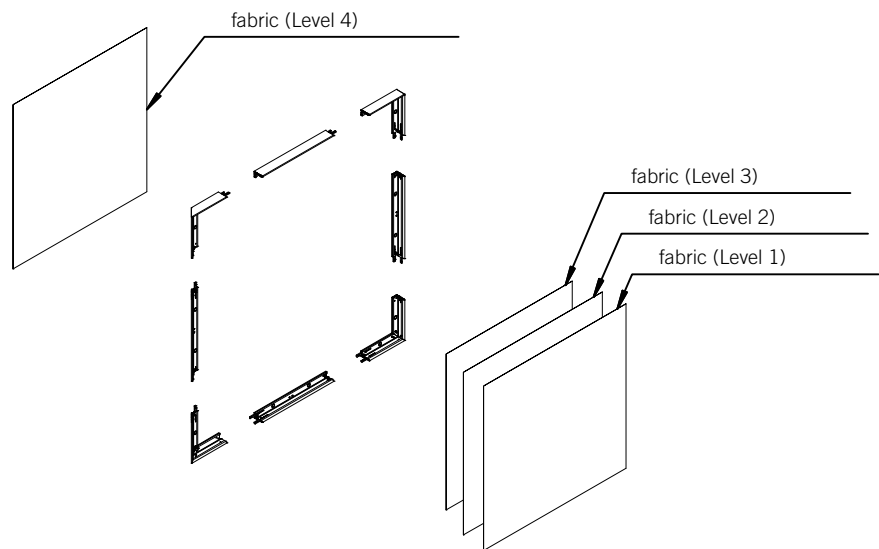

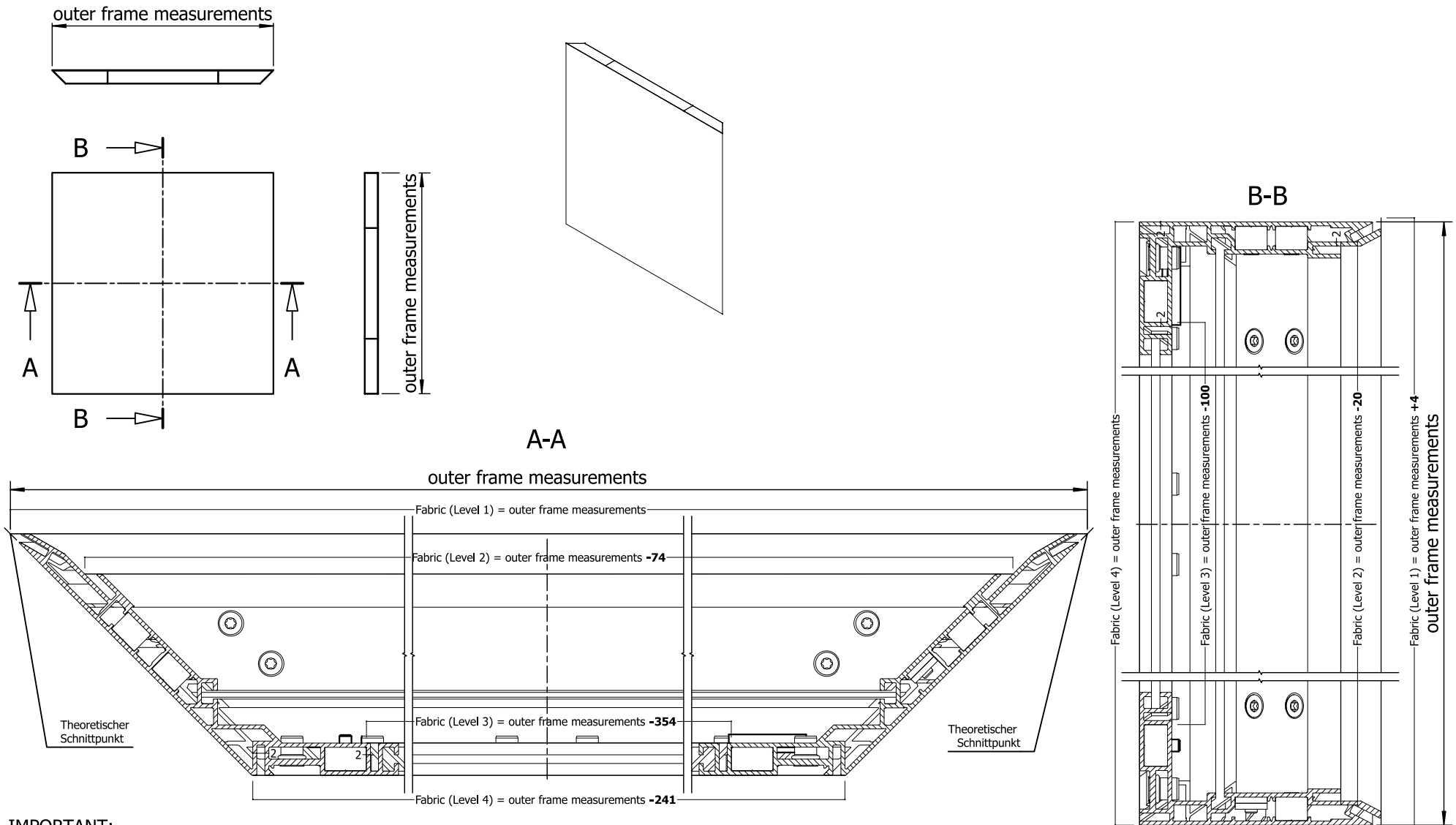

IMPORTANT:
 We recommend to **only** use elastic fabrics.
 Always do a test run first and try to mount the fabric to a frame!

TI-U-S32.0 E-000606-2230A-T01A gez. ED 02.02.2017

EXPLODED DRAWING FRAME ELEMENT OCTALUMINA PLUS UNIVERSAL TYPE C

TI-U-S32.1

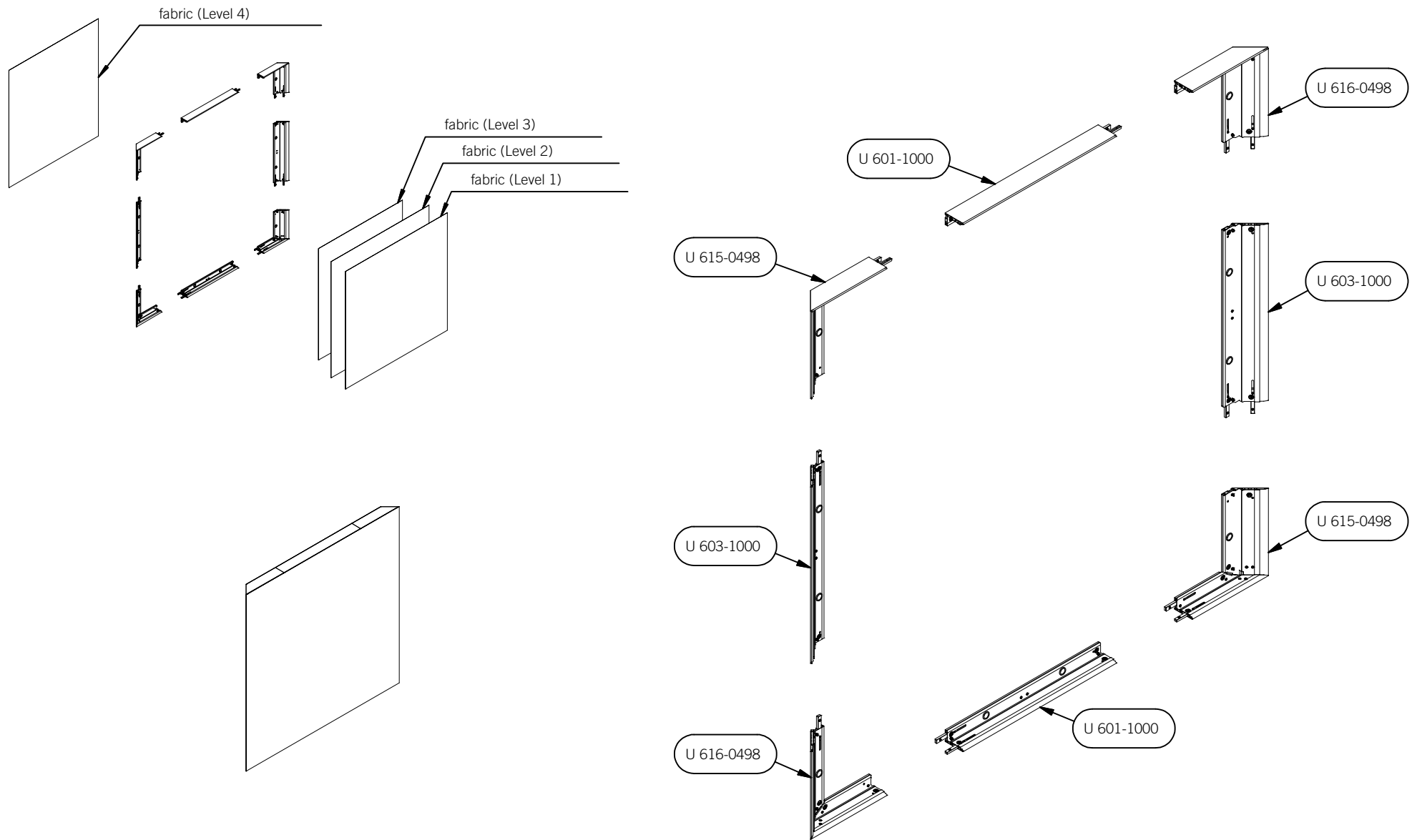

ASSEMBLY POSITION UPRIGHT FOOTING U 19

TI-U-U19

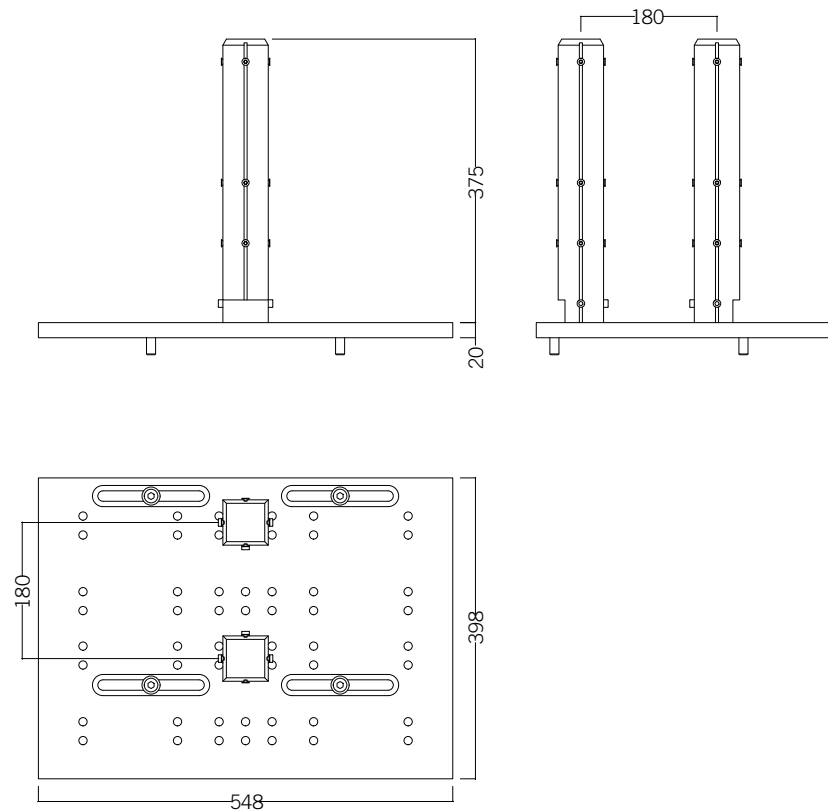
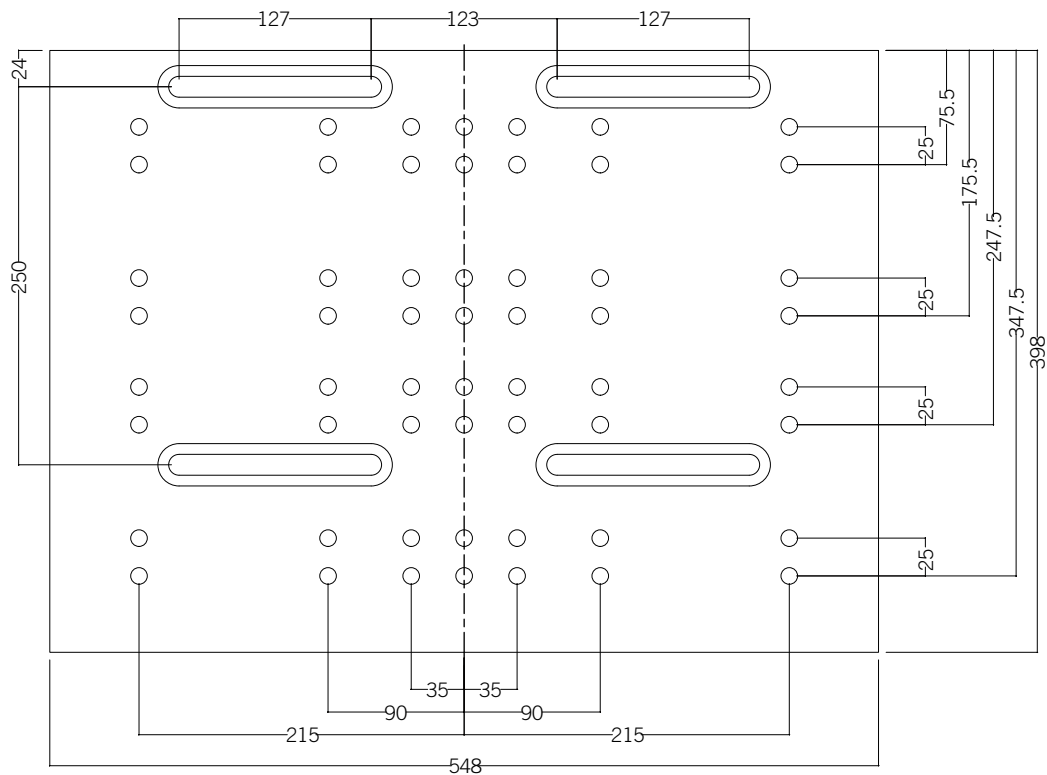

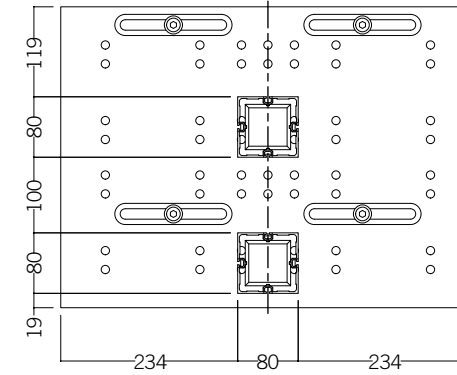
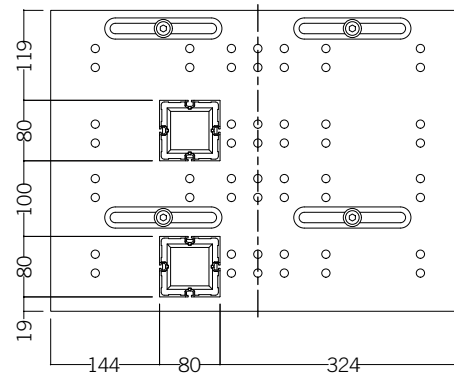
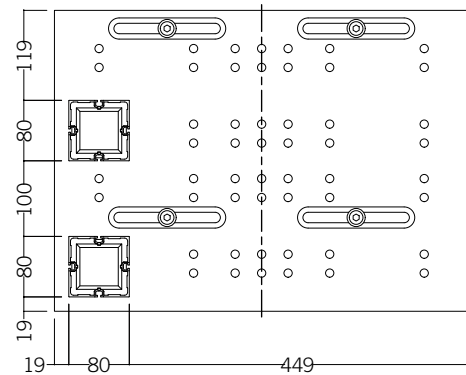
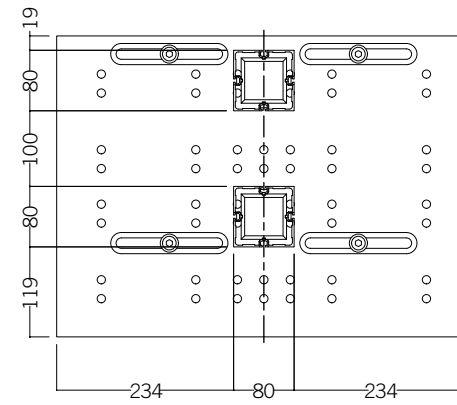
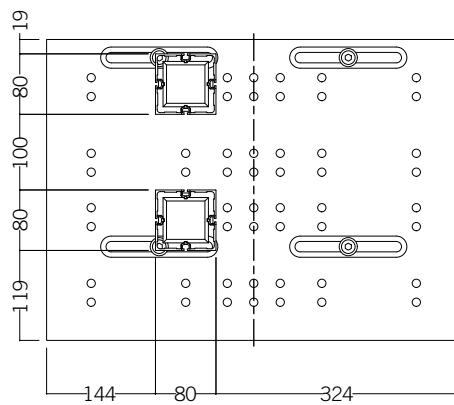
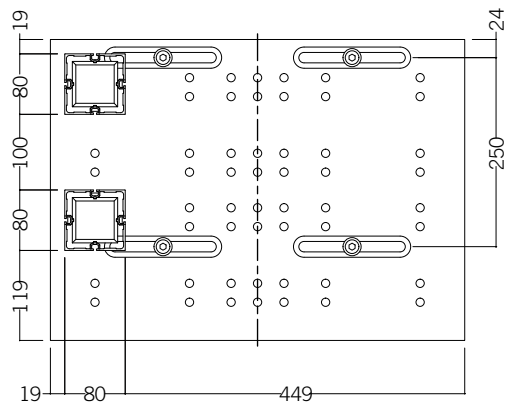

valid for U WH66V, U WH65V, U WH64V

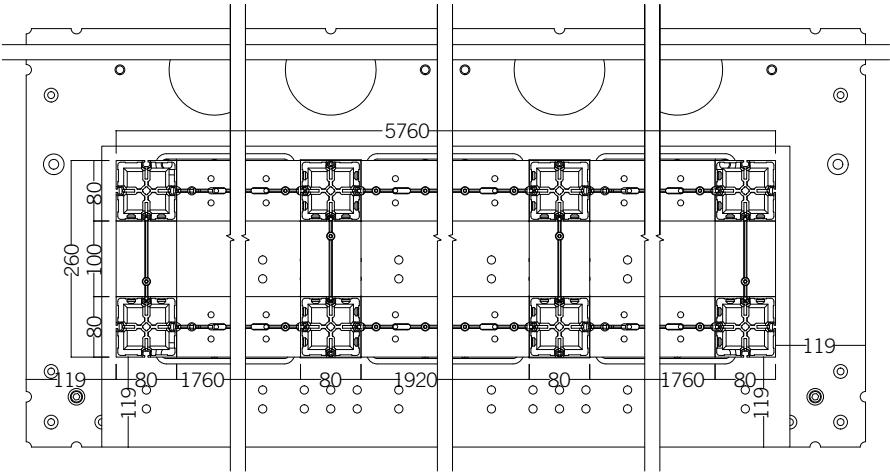
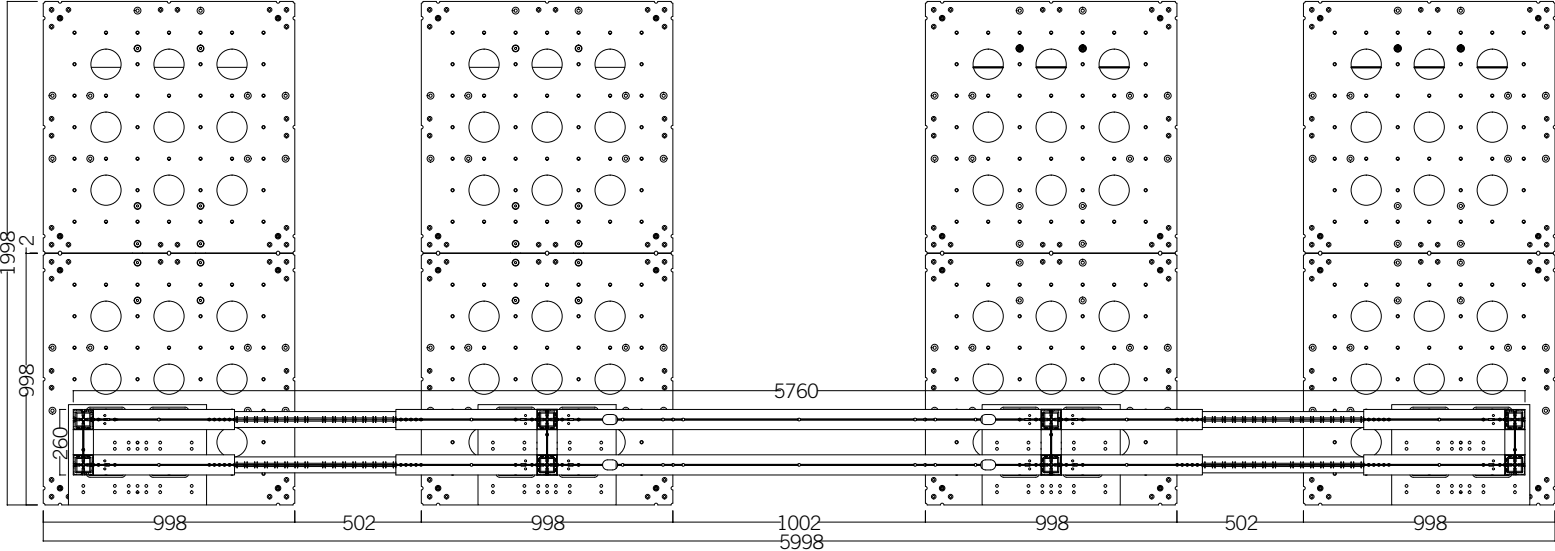

TIU-WH6654V.D E-000604-065VA-T10 A

**OCTANORM Germany
Head Office**

Raiffeisenstraße 39
70794 Filderstadt
T. +49 711 77003 0
F. +49 711 77003 53
info@octanorm.de
www.octanorm.com

EUROPE

OCTANORM® Adria
T. +386 590 56 301
www.octanormadria.com

OCTANORM® Belgium
T. +32 (0)475 35 60 76
www.octanorm.be

OCTANORM® Espana
T. +34 930 019 424
www.octanorm.es

OCTANORM® France
T. +33 679 113 205
www.octanorm.fr

OCTANORM® Hellas
T. +30 2310 7965 21
www.octanorm.gr

OCTANORM® Italia
T. +39 031 2269715
www.octsystem.it

OCTANORM® Nordic
T. +46 8 621 65 00
www.octanorm.se

OCTANORM® Polska
T. +48 22 773 03 50
www.octanorm.pl

OCTANORM® Russia
T. +7 495 565 7920
www.octanorm.ru

OCTANORM® UK
T. +44 20 85 452 945
www.octanorm.co.uk

NORTH AMERICA

OCTANORM® North America
T. +1 770 7 32 1520
www.octanormna.com

CENTRAL AMERICA

OCTANORM® México
T. +52 55 5804 6325
www.octanorm.com.mx

SOUTH AMERICA

OCTANORM® Argentina
T. +54 11 4312 4000
www.octanorm.com.ar

AFRICA

OCTANORM® South Africa
T. +27 11 433 2010
www.octanorm.co.za

MIDDLE EAST

OCTANORM® Emirates
T. +971 4 340 6888
www.alfajer.net

AUSTRALIA / SOUTH PACIFIC

OCTANORM® Australia
T. +61 3 8773 8550
www.octanorm.com.au

ASIA

OCTANORM® China
T. +86 5126 283 3336
www.octanorm.cn

OCTANORM® Japan
T. +81 45 511 8144
www.octanorm.co.jp