

octawall 40

classic/toolless

Technics 05/26

Light weight frame system

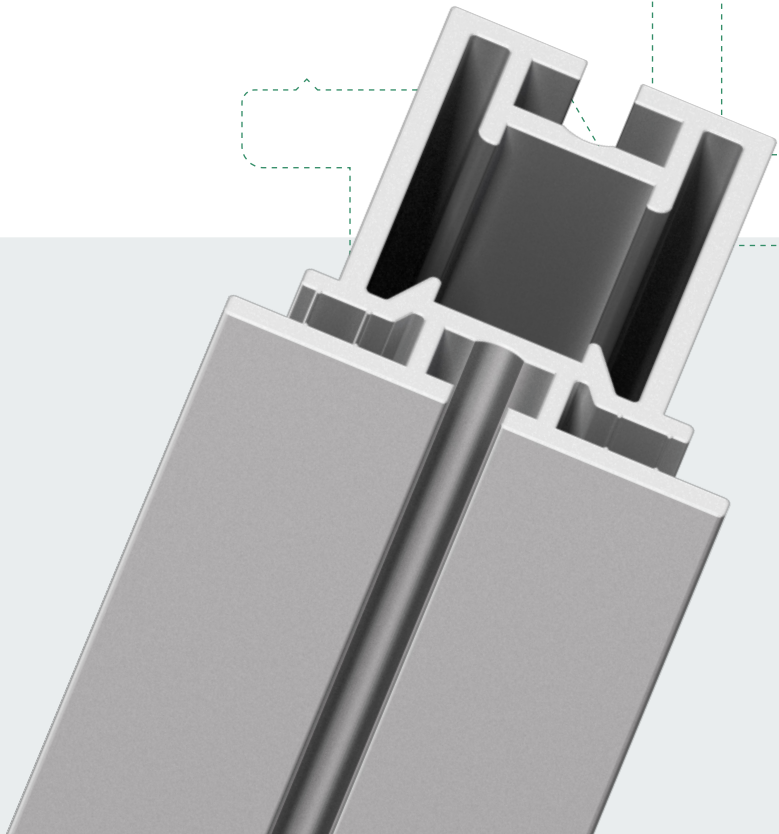

↗ Contents

↗ octawall 40 classic	4
↗ octawall 40 toolless	92

octawall 40 classic

↗ Technics 05/26

Light weight frame system for fabric and panel

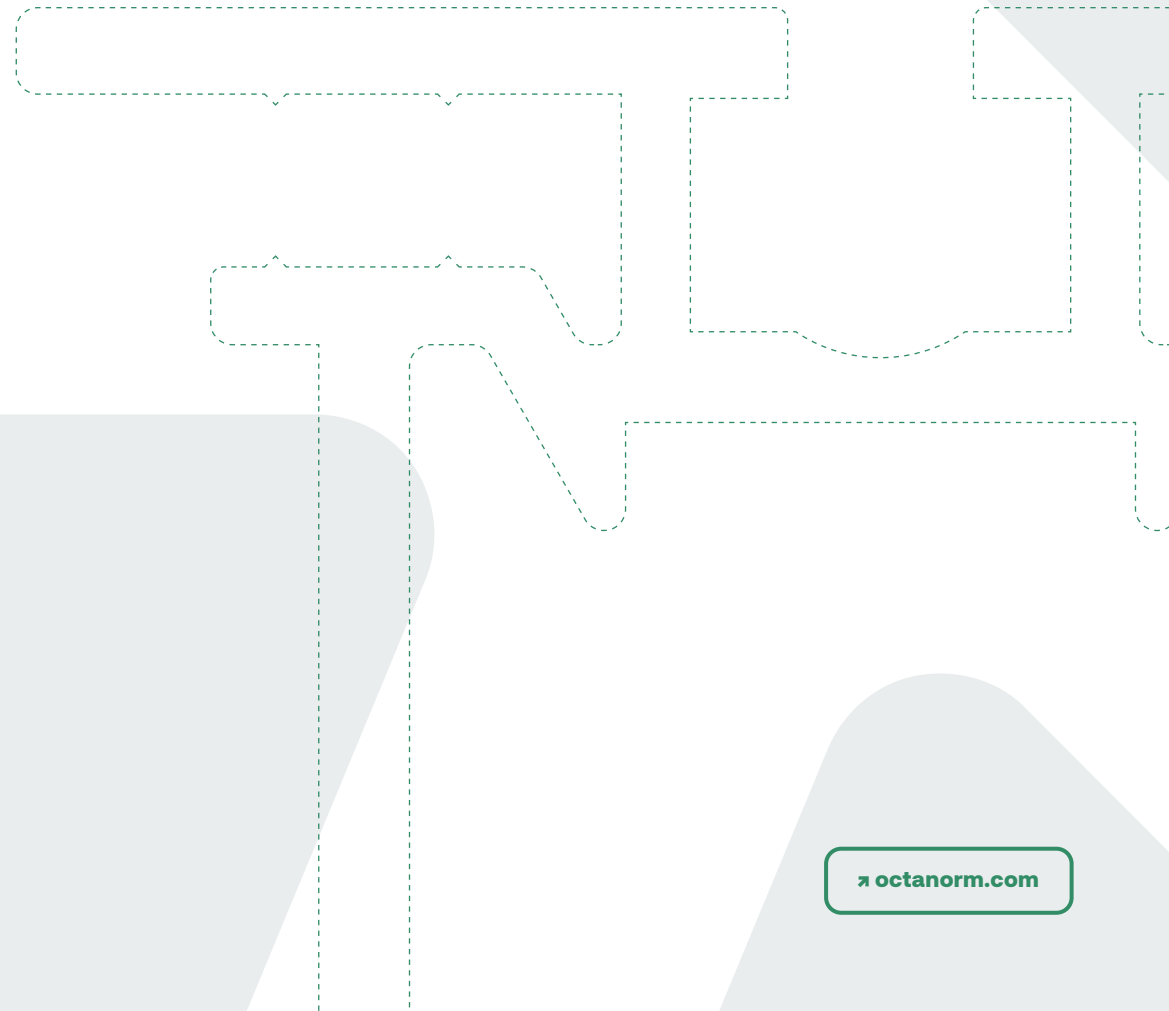
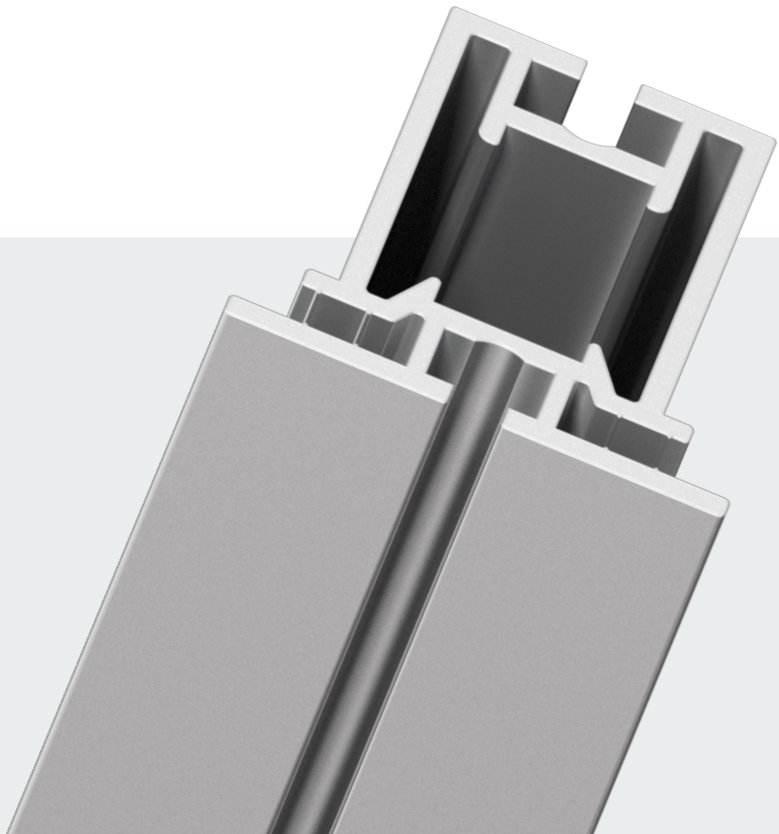

➤ Contents

➤ octawall 40 classic	
➤ Frames	5
➤ Basic parts	11
➤ Accessories	21
➤ Safety parts	33
➤ Doors	34
➤ Fabric/Panel/Glass	37
➤ Hinges	38
➤ Electrical parts	39
➤ Packing/Transport	44
➤ technical information	46

Frames

octawall 40 classic

Frame

for fabric and panel
W 990 × H 2480 × D 40 mm



W 440/E.01

aluminium

1 × frame of W 906 for double sided fabric/panel, for mounting on frame or extrusion, incl. 2 × C 440/F adjustable foot and 3 × mounting-set M 1477, incl. hook tape W 840, with W 916 internal corner connector (no mitre needed), with drillings for M 1951 and M 1953, Drillings for cable management possible on request, fabric dimension = outer frame dimension

W 990 × H 2480 × D 40 mm | 7.85 kg

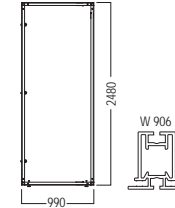

Frame

for double sided fabric / panel
W 990 × H 2480 × D 40mm



W 440/S.01

aluminium

1 × frame of W 906 for double sided fabric/panel, incl. 4 × corner inlay W 916/S, 4 × tension lock Z 961/8, optional: 2 × adjustable foot C 440/F, 3 × mounting set frame-upright M 1477, 3 × quick connector frame-frame WP 80-1, hook tape W 840, Drillings for cable management possible on request

W 990 × H 2480 × D 40mm | 7.672 kg

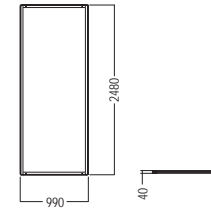

1 fabric dimension =
outer frame dimension

Frame

for double sided fabric / panel
W 950 × H 2480 × D 40 mm



W 442/E.01

aluminium

1 × frame of W 906 for double sided fabric/panel, for installation between 2 extrusions, incl. 2 × C 440/F adjustable foot and 6 × mounting-set M 1477, incl. hook tape W 840, with 4 × internal corner connector W 916 (no mitre needed), with drillings for M 1951 and M 1953, drillings for cable management possible on request

W 950 × H 2480 × D 40 mm | 7.76 kg

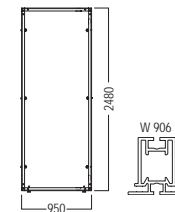

1 fabric dimension =
outer frame dimension

Frames

octawall 40 classic

Frame

for double sided fabric / panel
W 950 × H 2480 × D 40 mm



W 442/S.01

aluminium

1 × frame of W 906 for double sided fabric/panel, incl. 4 × corner inlay W 916/S, 4 × tension lock Z 961/8, optional: 2 × adjustable foot C 440/F, 3 × mounting set frame-upright M 1477, 3 × quick connector frame-frame WP 80-1, hook tape W 840, Drillings for cable management possible on request

W 950 × H 2480 × D 40 mm | 7.588 kg

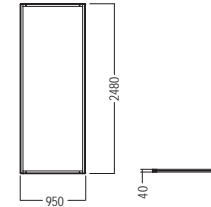

1 fabric dimension =
outer frame dimension

Frame

for double sided fabric / panel
W 455 × H 2480 × D 40 mm



W 449/E.01

aluminium

1 × frame of W 906 for double sided fabric/panel, for installation between 2 extrusions, incl. 2 × C 440/F adjustable foot and 6 × mounting-set M 1477, incl. hook tape W 840, with 4 × internal corner connector W 916 (no mitre needed), with drillings for M 1951 and M 1953, drillings for cable management possible on request

W 455 × H 2480 × D 40 mm | 6.73 kg

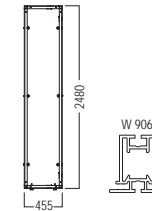

1 fabric dimension =
outer frame dimension

Frame

for double sided fabric / panel
W 455 × H 2480 × D 40 mm



W 449/S.01

aluminium

1 × frame of W 906 for double sided fabric/panel, incl. 4 × corner inlay W 916/S, 4 × tension lock Z 961/8, optional: 2 × adjustable foot C 440/F, 3 × mounting set frame-upright M 1477, 3 × quick connector frame-frame WP 80-1, hook tape W 840, Drillings for cable management possible on request

W 455 × H 2480 × D 40 mm | 7.524 kg

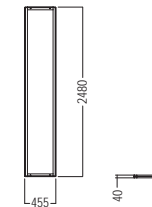

1 fabric dimension =
outer frame dimension

Frames

octawall 40 classic

Frame

for double sided fabric / panel
40 mm, custom size



W 444/E.01

aluminium

1 × frame of W 906 for double sided fabric/panel, for installation between 2 frames or 2 extrusions, incl. 2 × C 440/F adjustable foot and mounting-set M 1477, incl. hook tape W 840, with 4 × internal corner connector W 916 (no mitre needed), with drillings for M 1951 and M 1953, drillings for cable management possible on request
40 mm, custom size |

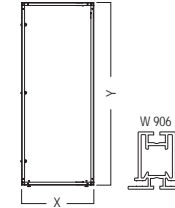

1 dimensions and accessories have to be stated on order

1 fabric dimension = outer frame dimension

Frame

for double sided fabric / panel
40 mm, custom size



W 444/S.01

aluminium

1 × frame of W 906 for double sided fabric/panel, incl. 4 × corner inlay W 916/S, 4 × tension lock Z 961/8, optional: 2 × adjustable foot C 440/F, 3 × mounting set frame-upright M 1477, 3 × quick connector frame-frame WP 80-1, hook tape W 840, Drillings for cable management possible on request
40 mm, custom size |

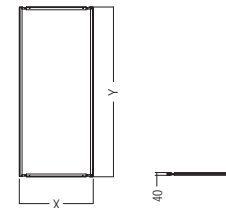

1 fabric dimension = outer frame dimension

frame element curved

for double sided fabric / panel
W 515 × H 2480 × D 40 mm



W 441/E.01

aluminium

1 × frame of W 906 for double sided fabric/panel, for mounting on frame or 2 extrusion, incl. 2 × C 440/F adjustable foot and 3 × mounting-set M 1477, incl. hook tape W 840, with 4 × internal corner connector W 916 (no mitre needed), with drillings for M 1951 and M 1953, Drillings for cable management possible on request
W 515 × H 2480 × D 40 mm | 7.74 kg

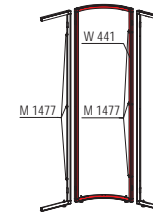
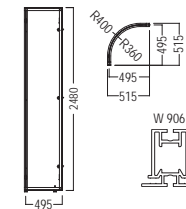

1 When combining several curved frames, deviations may occur at the joints.

1 fabric dimension = outer frame dimension

Frames

octawall 40 classic

frame element curved

for double sided fabric / panel
W 515 x H 2480 x D 515 mm



W 441/S.01

aluminium

1 x frame of W 906 for double sided fabric/panel, incl. 4 x corner inlay W 916/S, 4 x tension lock Z 961/8, optional: 2 x adjustable foot C 440/F, 3 x mounting set frame-upright M 1477, 3 x quick connector frame-frame WP 80-1, hook tape W 840, Drillings for cable management possible on request, extrusions have a straight run-out of 115 mm

W 515 x H 2480 x D 515 mm | 7.613 kg

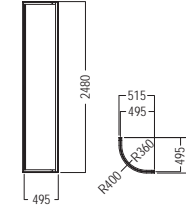

! When combining several curved frames, deviations may occur at the joints.

i fabric dimension = outer frame dimension

frame element curved

for double sided fabric / panel
40 mm, custom size



W 443/E.01

aluminium

1 x curved frame of W 906 for double sided fabric/panel, for installation between 2 frames or 2 extrusions, incl. 2 x C 440/F adjustable foot and mounting-set M 1477, incl. hook tape W 840, with 4 x internal corner connector W 916 (no mitre needed), with drillings for M 1951 and M 1953, Drillings for cable management possible on request

40 mm, custom size |

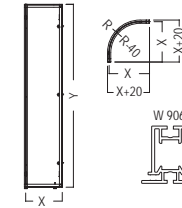

! dimensions and accessories have to be stated on order

i fabric dimension = outer frame dimension

frame element curved

for double sided fabric / panel
40 mm, custom size



W 443/S.01

aluminium

1 x frame of W 906 for double sided fabric/panel, incl. 4 x corner inlay W 916/S, 4 x tension lock Z 961/8, optional: 2 x adjustable foot C 440/F, 3 x mounting set frame-upright M 1477, 3 x quick connector frame-frame WP 80-1, hook tape W 840, Drillings for cable management possible on request

40 mm, custom size |

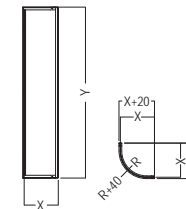

! When combining several curved frames, deviations may occur at the joints.

i fabric dimension = outer frame dimension

Frames

octawall 40 classic

Frame

for fabric, dividable
W 950 × H 2480 × D 40 mm



W 932.01

aluminium

1 × frame of M 1307 for double sided fabric, dividable in the centre, incl. 2 × C 440/F adjustable foot and 4 × mounting-set M 1477, with 4 × corner connector Z 990, with drillings for M 1951 and M 1953, drillings for cable management possible on request

W 950 × H 2480 × D 40 mm | 8.08 kg

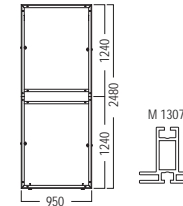

1 fabric dimension =
outer frame dimension

Frame

for double sided fabric
W 950 × H 2480 × D 40 mm



W 942/E.01

aluminium

1 × frame of M 1307 for double sided fabric, for mounting on frame or extrusion, incl. 2 × C 440/F adjustable foot and 3 × mounting-set M 1477, with 4 × internal corner connector W 916 (no mitre needed), with drillings for M 1951 and M 1953, drillings for cable management possible on request

W 950 × H 2480 × D 40 mm | 7.122 kg

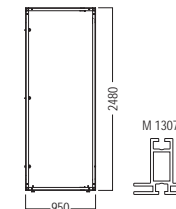

1 fabric dimension =
outer frame dimension

Frame

for double sided fabric
W 455 × H 2480 × D 40 mm



W 949/E.01

aluminium

1 × frame of M 1307 for double sided fabric, for mounting on frame or extrusion, incl. 2 × C 440/F adjustable foot and 3 × mounting-set M 1477, with 4 × internal corner connector W 916 (no mitre needed), with drillings for M 1951 and M 1953, drillings for cable management possible on request

W 455 × H 2480 × D 40 mm | 6.279 kg

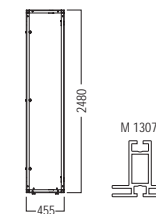

1 fabric dimension =
outer frame dimension

Frames

octawall 40 classic

Frame

for double sided fabric
40 mm, custom size



W 944/E.01

aluminium

1 x frame of M 1307 for double sided fabric, for mounting on frame or extrusion, incl. 2 x C 440/F adjustable foot and mounting-set M 1477, with 4 x internal corner connector W 916 (no mitre needed), with drillings for M 1951 and M 1953, drillings for cable management possible on request

40 mm, custom size |

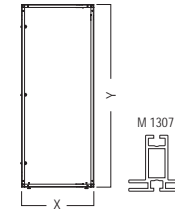

! dimensions and accessories have to be stated on order

i fabric dimension = outer frame dimension

Ceiling element

for fabric
L 950 x W 2480 x H 40 mm



D 931.01

aluminium

1 x frame of M 1305 used as ceiling element, for fabrics in combination with silicone edge M 1313, incl. 4 x connector Z 910 for system groove

L 950 x W 2480 x H 40 mm | 10.17 kg

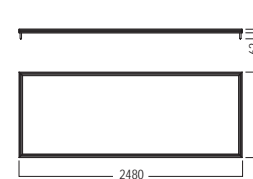

! For flush mounting of ceiling element: 4 x T-connector W 466

i fabric dimension = outer frame dimension

Basic parts

octawall 40 classic

Tension fabric extr.

for double sided fabric / panel
L 6000 × W 40 × H 40 mm

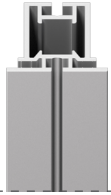

W 906.01

aluminium

for double-sided fabric (in combination with silicone edge M 1313)
or panels

L 6000 × W 40 × H 40 mm | 6.345 kg

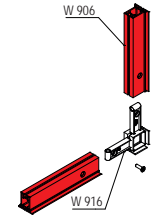
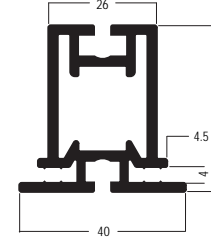

Tension fabric extr.

for double-sided fabric
L 6000 × W 40 × H 40 mm



M 1307.01

aluminium

for double-sided fabric (with silicone edge M 1313)

L 6000 × W 40 × H 40 mm | 5.392 kg

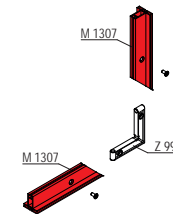
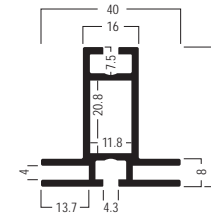

Tension fabric extr.

for double sided fabric
L 6000 × W 40 × H 40 mm

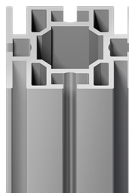

M 1305.01

aluminium

for double sided fabric (with silicone edge M 1313), with 4 grooves
to fix fabric, tension lock Z 961/8 can be mounted in 2 positions

L 6000 × W 40 × H 40 mm | 8.234 kg

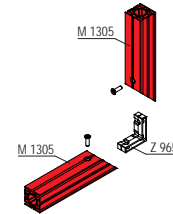
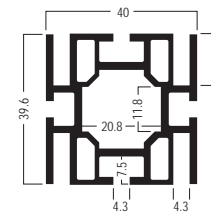

Basic parts

octawall 40 classic

Corner upright extrusion

90° corner
with silicone edge groove



S 382.01

aluminium

90°, for connection of octawall 40 frames, fabric can be mounted over the extrusion right to the edge

L 5000 × W 40 × H 40 mm | 6.912 kg

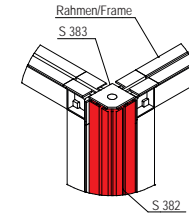
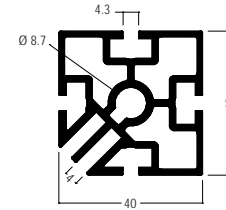

Corner upright

90° corners
with silicone edge groove



S 381.01

aluminium

1 × corner extrusion of S 382, for connection of octawall 40 frames across corners, fabric can be mounted over the extrusion right to the edge, incl. 2 × end cap S 383 and 1 × adjustable foot W 913/1

L 40 × W 40 × H 2480 mm | 3.62 kg

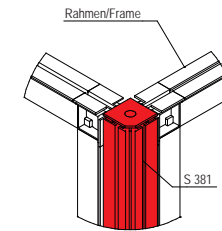
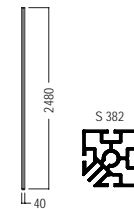

1 Cut length = height - 12 mm

Square extrusion

4 system grooves
L 5000 × W 40 × H 40 mm

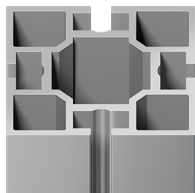

M 1000.01

aluminium

for connection on 4 sides, tension lock Z 961/8 can be mounted in 2 positions, with 4 system grooves, groove depth 7 mm

L 5000 × W 40 × H 40 mm | 5.782 kg

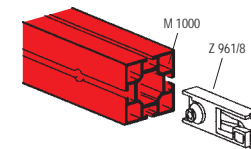
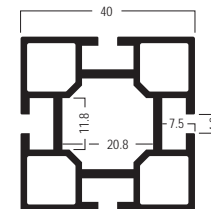

Basic parts

octawall 40 classic

Corner upright

90°
with adjustable foot W 913

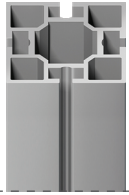

W 990.01

aluminium

1 × corner extrusion 90° of M 1000, incl. 1 × adjustable foot W 913
L 40 × W 40 × H 2500 mm | 3.2 kg

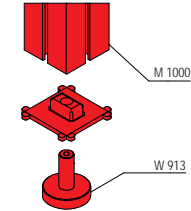
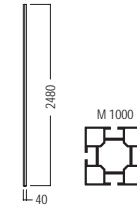

Corner upright

90°, dividable
with adjustable foot C 430

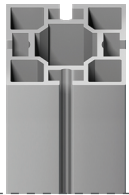

W 992.01

aluminium

1 × corner extrusion 90° of M 1000, divided, for corner connection of frames W 930 and W 932, 2 × extrusion M 1000, 1 × internal connector straight Z 978, 1 × adjustable foot C 430
L 40 × W 40 × H 2500 mm | 3.3 kg

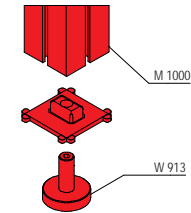
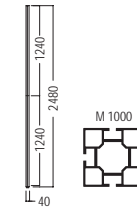

Square extrusion

4 system grooves
L 6000 × W 40 × H 40 mm

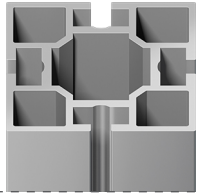

M 1001.01

aluminium

for connection on 4 sides, tension lock Z 961/8 can be mounted in 2 positions, with 4 system grooves, groove depth 7 mm
L 6000 × W 40 × H 40 mm | 6.97 kg

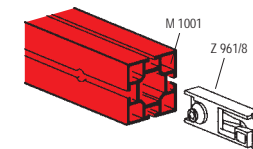
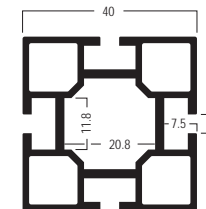

Basic parts

octawall 40 classic

Square extrusion

3 system grooves
L 6000 × W 40 × H 40 mm

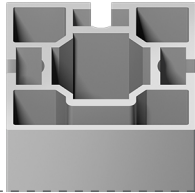

M 1005.01

aluminium

for connection on 3 sides, tension lock Z 961/8 can be mounted in 2 positions, with 3 system grooves, groove depth 7 mm

L 6000 × W 40 × H 40 mm | 6.664 kg

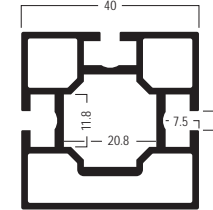

Square extrusion

2 system grooves
90° corner

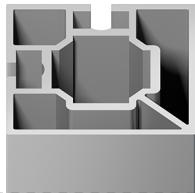

M 1007.01

aluminium

90° corner, for connection on 2 sides, tension lock Z 961/8 can be mounted in 2 positions, with 2 system grooves, groove depth 7 mm

L 6000 × W 40 × H 40 mm | 7.174 kg

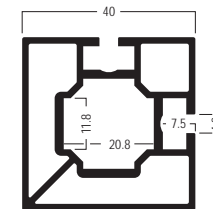

Angle extrusion

135° corner
L 6000 × W 40 × H 50 mm

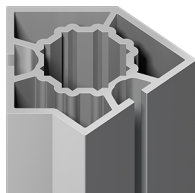

M 1009.01

aluminium

135°, for connection on 2 sides, tension lock Z 961/8 can be mounted in 2 positions

L 6000 × W 40 × H 50 mm | 7.818 kg

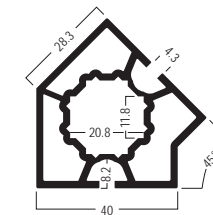

Basic parts

octawall 40 classic

Double triangular

corner
L 6000 × W 40 × H 56 mm



M 1072.01

aluminium

for corners, for connection on 2 sides, can also be mounted horizontally for wall bracing

L 6000 × W 40 × H 56 mm | 4.848 kg

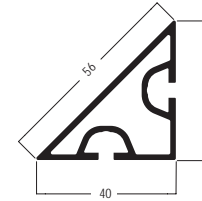

Corner upright extrusion

90° corner, round
L 6000 × W 120 × H 120 mm

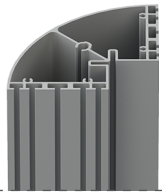

M 260.01

aluminium

for connecting extrusions with width 16, 40, 80, 120 mm, octawall pro or octawall 40 frames, fabric can be stretched over the extrusion

L 6000 × W 120 × H 120 mm | 25.5 kg

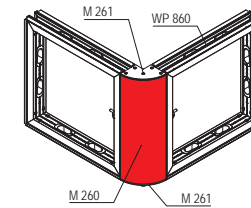
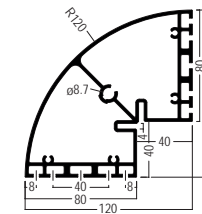

Quick connector

Set
for octawall frames

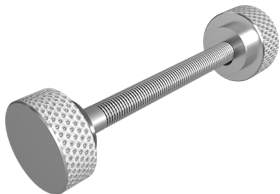

WP 80-1.90

steel

M8, for connecting frame elements octawall

L 136 × W 40 × H 40 mm | 0.099 kg

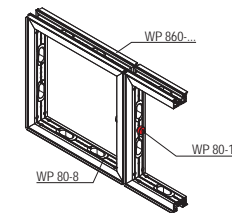
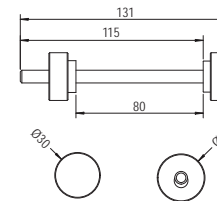

Caution: check existing connections after transport

Basic parts

octawall 40 classic

Fixing set

for M 1307 / M 1304
for frame connection

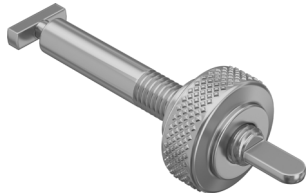

M 1478.37

steel

for frame connection, quick mounting of extrusion M 1307 and M 1304 to system groove 4.3 mm

L 74 × W 21.7 × H 21.7 mm | 0.048 kg

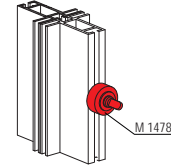
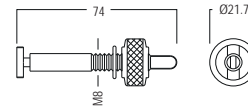

drilling of frames
offset

Fixing set

for frame connection
L 74 × W 39 × H 39 mm



M 1477.37

steel

for connection of frames W 940 - W 949 / M 1304 / M 1305 and M 1307

L 74 × W 39 × H 39 mm | 0.035 kg

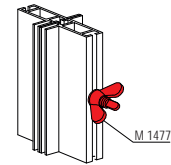
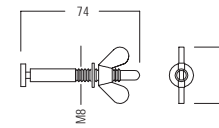

drilling of frames
offset

Fixing set

for frame connection
L 100 × W 39 × H 39 mm

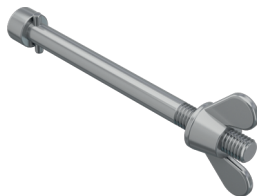

M 1496.37

steel

for connection of frame elements

L 100 × W 39 × H 39 mm | 0.066 kg

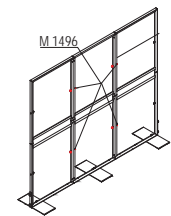
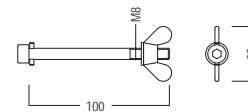

drilling of frames at
same level

Basic parts

octawall 40 classic

Knuckle

90°
for W 906 / M 1307



W 916.39

zinc die cast

for connection of 2 fabric tension extrusions, 90°, incl. 2 × screw E 111/m and M 1510/20, for connection of 2 fabric tension extrusions, with thread M 10 for installation of adjustable foot C 440/F

L 106 × W 106 × H 40 mm | 0.215 kg

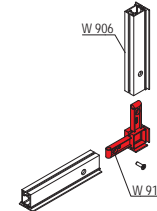
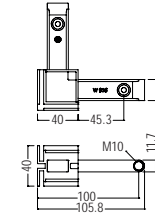

Corner connector

90°
lock chamber 21 × 12 mm

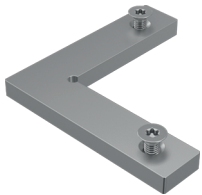

Z 966.00

aluminium

90°, for lock chamber 21 × 12 mm, with 2 × E 111 and E 111/20 countersunk screw

L 90 × W 90 × H 8 mm | 0.082 kg

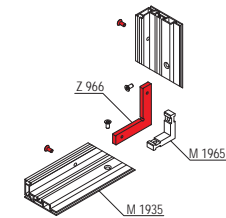
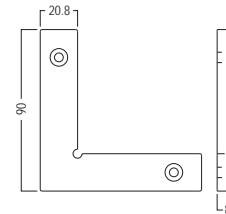

Internal connector

straight
lock chamber 21 × 12 mm



Z 967.00

aluminium

straight, for extrusions with lock chamber 21 × 12 mm and hole 13 mm dia., incl. 1 × set screw Z 967/20 (M6), 2 × hex-star screw E 111/m (M6), 2 × countersunk screw M 1102/20 (M6) and 2 × washer Z 185

L 181 × W 12 × H 21 mm | 0.128 kg

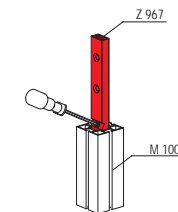
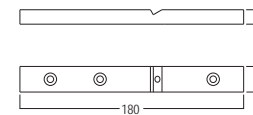

Basic parts

octawall 40 classic

Internal connector

straight, toolless
lock chamber 21 × 12 mm



Z 978.90

aluminium

straight, toolless, for vertical connection of upright extrusions with lock chamber of 21 × 12 mm and holes 8 mm dia., with push button setting for assembly without tools

L 180 × W 21 × H 12 mm | 0.109 kg

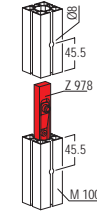
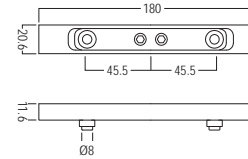

Internal connector

straight, toolless
lock chamber 21 × 12 mm



Z 977.90

aluminium

straight, toolless, for all beam extrusions with lock chamber 21 × 12 mm and hole 13 mm dia., with push button setting for assembly without tools

L 180 × W 21 × H 12 mm | 0.106 kg

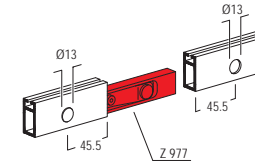
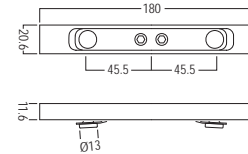

Beam extrusion

for bracing
groove depth 7 mm



Z 308.01 | .11

aluminium

for bracing, tension lock Z 961/f3 can be mounted, groove depth 7 mm

L 5000 × W 32 × H 16 mm | 2.68 kg

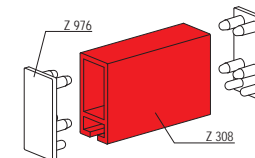
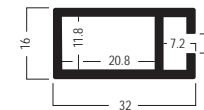

Basic parts

octawall 40 classic

Beam extrusion

2 system grooves
L 5000 × W 40 × H 16 mm



Z 4400.01

aluminium

2 system grooves, tension lock Z 961/13 can be mounted, groove depth 7 mm

L 5000 × W 40 × H 16 mm | 3.2 kg

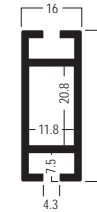

Distance piece

for holes 13 mm

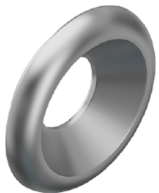

Z 185.01

aluminium

for 13 mm hole in combination with countersunk screw E 111

L 13 × B 0 × H 0 mm |

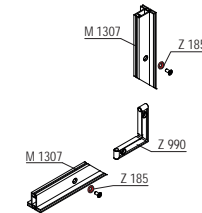
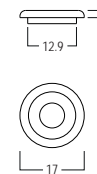

Tension lock

8 mm
L 70 × W 20 × H 12 mm

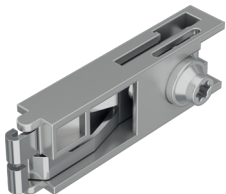

Z 961/8.00

zinc die cast/steel

8 mm, for all beam extrusions with cross- or T-lock chamber 21 × 12 mm

L 70 × W 20 × H 12 mm | 0.054 kg

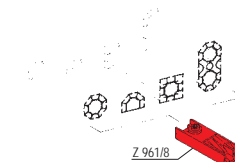
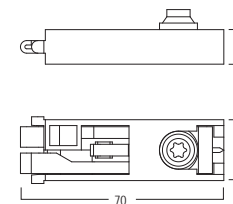

Basic parts

octawall 40 classic

Tension lock

13 mm
L 70 × W 21 × H 13 mm

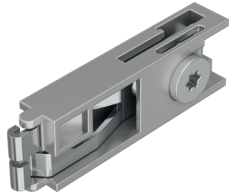

Z 961/13.00

zinc die cast/steel

13 mm, for all beam extrusions with lock chamber 21 × 12 mm as well as in conjunction with adaptor Z 161/A, for beam extrusions with lock chamber 39 × 12 mm

L 70 × W 21 × H 13 mm | 0.052 kg

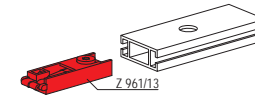
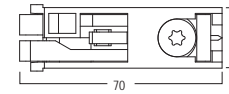
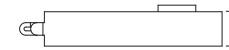

Accessories

octawall 40 classic

Adjustable foot

M10
for frame elements



C 440/F.37

steel

for installation in frame elements in connection with Z 990 internal corner connector or W 916/S corner connector

L 40 × W 40 × H 80.5 mm | 0.073 kg

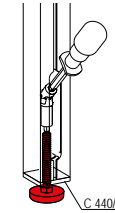
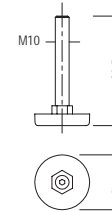

Adjustable foot

for uprights 40 × 40 mm
L 39 × W 39 × H 34 mm

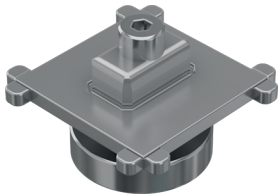

W 913.37

steel

for extrusions M 1000 / M 1001 / M 1005 and M 1007

L 39 × W 39 × H 34 mm | 0.066 kg

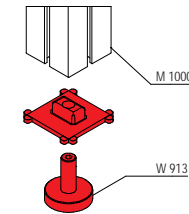
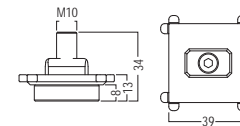

Adjustable foot

135° corner
for upright M 1009



C 441.37

steel, zinc plated

for exterior corner extrusion M 1009, 135°, incl. 2 × set screw M 1075/20 (M4)

L 53 × W 39 × H 80 mm | 0.158 kg

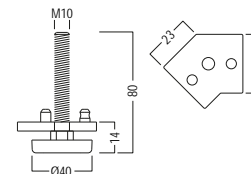

Accessories

octawall 40 classic

Base plate

side

L 495 x W 170 x H 301 mm

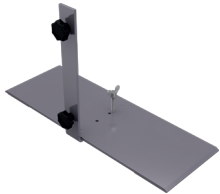

M 1941.21

steel

for free standing frames made of extrusions M 1304, M 1305, M 1307, W 906, for side mounting and additional connecting to bottom beam, incl. 1 x mounting parts M 1951BS, max. frame height = 2000 mm

L 495 x W 170 x H 301 mm | 5.338 kg

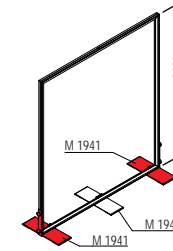
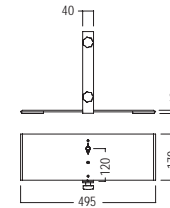

Suitable for both left and right side

Base plate

middle

L 495 x W 170 x H 12 mm

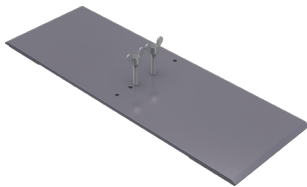

M 1943.21

steel

for free standing frames made from extrusions M 1304, M 1305, M 1307, M 1308, W 906, additional center base plate for connecting to bottom beam, incl. 1 x mounting parts M 1953BS, max. frame height = 2000 mm

L 495 x W 170 x H 12 mm | 4.53 kg

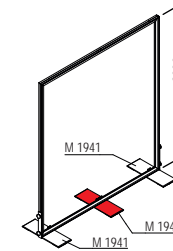
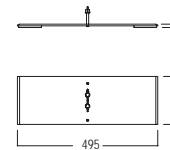

Attention: for use only with M 1941, M 1942

Base plate

side

L 600 x W 250 x H 301 mm



M 1951.21

steel

for free standing frames made from extrusions M 1304, M 1305, M 1307, W 906, for side mounting and additional connecting to bottom beam, incl. 1 x mounting parts M 1951BS, max. frame height = 2500 mm

L 600 x W 250 x H 301 mm | 8.45 kg

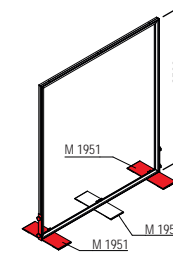
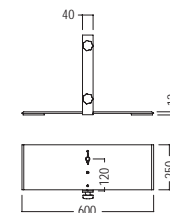

Suitable for both left and right side

Accessories

octawall 40 classic

Base plate

middle
L 600 × W 250 × H 12 mm

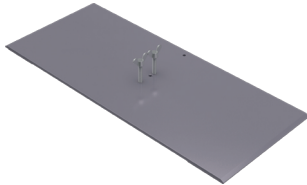

M 1953.21

steel

for free standing frames made from extrusions M 1304, M 1305, M 1307, W 906, additional center base plate for connecting to bottom beam, incl. 1 × mounting parts M 1953BS, max. frame height = 2500 mm

L 600 × W 250 × H 12 mm | 7.642 kg

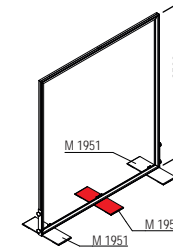
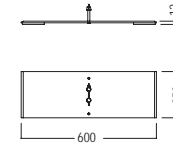

Attention: for use only with M 1951, M 1952

Base plate

side
L 320 × W 250 × H 301 mm

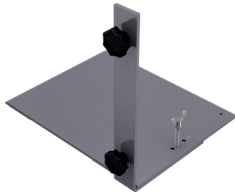

M 1961.21

steel

for free standing frames made from extrusions M 1304, M 1305, M 1307, W 906, for side mounting and additional connecting to bottom beam, off set for mounting close to walls, incl. 1 × mounting parts M 1951BS, max. frame height = 2500 mm

L 320 × W 250 × H 301 mm | 5.201 kg

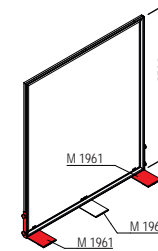
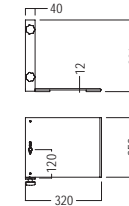

Suitable for both left and right side

Base plate

middle
L 320 × W 250 × H 12 mm

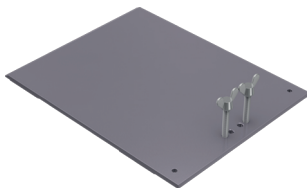

M 1963.21

steel

for free standing frames made from extrusions M 1304, M 1305, M 1307, W 906, additional center base plate for connecting to bottom beam, off set for mounting close to walls, incl. 1 × mounting parts M 1953BS, max. frame height = 2500 mm

L 320 × W 250 × H 12 mm | 4.393 kg

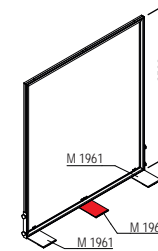
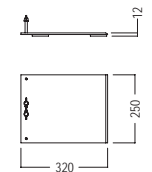

Attention: for use only with M 1961

Accessories

octawall 40 classic

Threaded plate

for C 440/F
L 25 × W 12 × H 21 mm



W 917.00

aluminium

to hold adjustable foot C 440/F in frame extrusions M 1307

L 25 × W 12 × H 21 mm | 0.023 kg

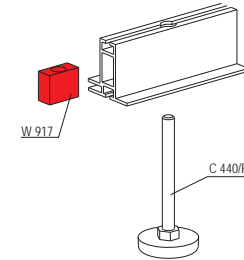
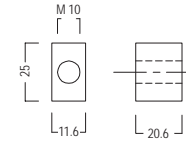

End cap

for extrusion S 382
L 40 × W 40 × H 6 mm

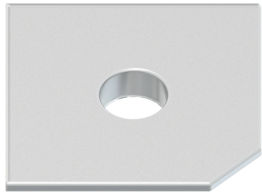

S 383.35

plastic

for extrusion S 382, to build the upper and lower piping groove on the edge

L 40 × W 40 × H 6 mm | 0.004 kg

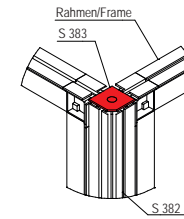
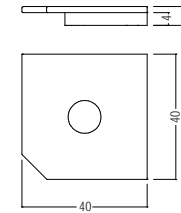

End cap

for extrusions 40 × 40 mm
L 40 × W 40 × H 12 mm



M 1014.33 | .35

plastic

for all square extrusions 40 mm

L 40 × W 40 × H 12 mm | 0.004 kg

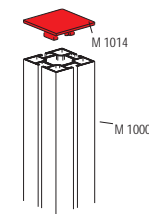
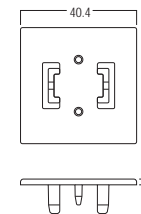

Accessories

octawall 40 classic

End plate

for 80 mm extrusions
for M 260



M 261.21

steel

for Quarter-round extrusion M 260 in connection with 80 mm extrusions, to create top and bottom horizontal fabric groove, with drilling 11 mm dia. for adjustable foot

L 120 × W 120 × H 6 mm | 0.335 kg

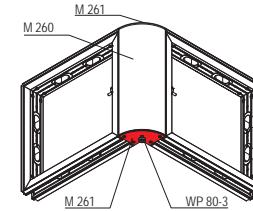
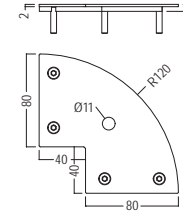

End plate

for 120 mm extrusions
for M 260

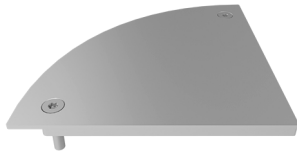

M 271.21

steel

for Quarter-round extrusion M 260 in connection with 120 mm extrusions, to create top and bottom horizontal fabric groove

L 120 × W 120 × H 6 mm | 0.45 kg

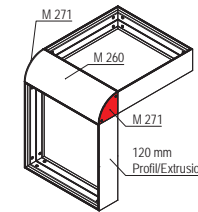
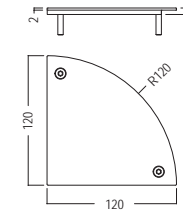

Cover extrusion

for extrusions 40 mm
L 5000 × W 40 × H 5 mm



W 910.01

aluminium

to clad the system groove, for frame elements with 40 mm, incl. 10 × plastic clip E 470/C

L 5000 × W 40 × H 5 mm | 1.34 kg

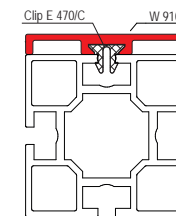

1 Recommendation: 2 × E 470/C per meter

Accessories

octawall 40 classic

Clip

for E 470/N / E 471/N
L 10 × W 9 × H 7 mm



E 470/C.30

plastic

to put into extrusion E 470/N / E 471/N, recommendation: 4 pieces / running meter for extrusion C 722, 2 pieces / running meter for extrusion W 910

L 10 × W 9 × H 7 mm |

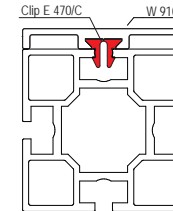
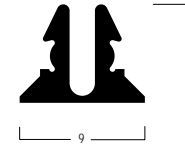

Monitor mount

VESA standard
for frame W 950-990 mm

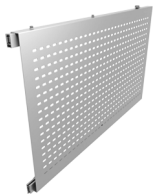

W 464.37

aluminium/steel

for octawall 40 frames with a width of 950 to 990 mm, for monitors with VESA standard 75 × 75 to 700 × 400 mm, for mounting of monitors to long holes, incl. 1 × tool E 114 for mounting

L 870-910 × W 30 × H 500 mm | 8.2 kg

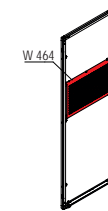
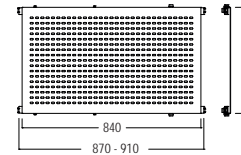

Attention: max. monitor weight 30 kg

Magnet fixing beam

for frame width 950 mm
for W 478 / W 476

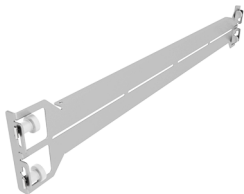

W 472.37

steel

for toolless installation of literature rack W 478 and shelf W 476 to frames, 1 × steel sheet E 472-A with 4 × hammerhead screw (M 1348/Ha) and 4 × knurled nut (E 735/t)

L 870 × W 19 × H 125 mm | 1.459 kg

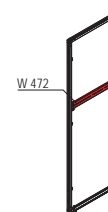
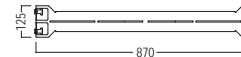

Attention: for frame width 950 mm

Accessories

octawall 40 classic

Magnet

for magnet fixing beam W 472
36 mm dia.



W 474.37

neodyme/steel

for mounting of literature rack W 478 and shelf W 476 to beam W 472, incl. 1 × hammerhead screw M 474-HA (M8) and 1 × washer M 1435-40 (M8)

36 mm dia. | 0.063 kg

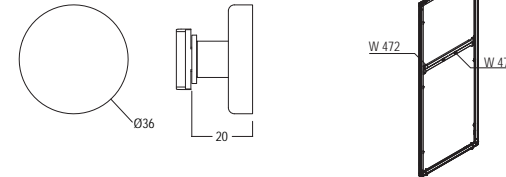

Brochure shelf

max. 2 kg
for magnet fixing beam W 472



W 478.20

steel

for fast mounting to beam W 472, incl. 2 × magnet W 474, mounted behind fabric

W 220 × H 304 mm | 1.663 kg

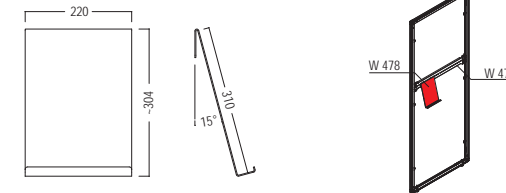

! Attention: max load capacity 2 kg!

Shelf

max. 2 kg
for magnet fixing beam W 472



W 476.20

steel

for fast mounting to beam W 472, incl. 2 × magnet W 474, mounted behind fabric

L 310 × W 220 × H 90 mm | 1.577 kg

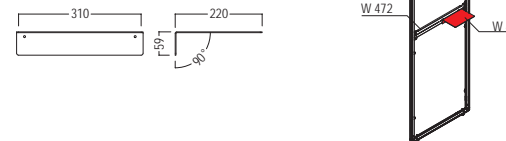

! Attention: max load capacity 2 kg!

Accessories

octawall 40 classic

Magnet retainer

max. 5 kg/200 mm
L 59 × W 17 × H 133 mm



MF 15.90

plastic, slate grey RAL 7015

with receiving slot for hook-in systems, with 15 × round magnet on the back for positioning on wall elements with fabric covered steel panels, non-slipping guaranteed for up to 5 kg distributed load

L 59 × W 17 × H 133 mm | 0.235 kg

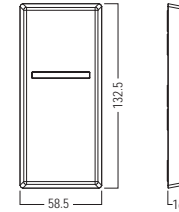

! max projection 200 mm, distributed load max. 5 kg

Steel plate

for 16 mm beam
L 300 × W 16 × H 200 mm



MF 80.37

steel, 2 mm thick

for use with 2 × beams with 16 mm depth

L 300 × W 16 × H 200 mm | 1.182 kg

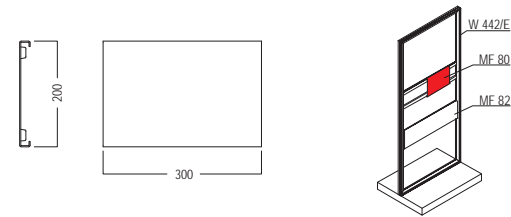

Tool set

assembly
for MF 4/MF 12/MF 15

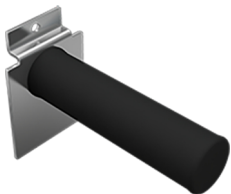

MF 1.90

steel/plastic, rubber

for easier assembly of magnetic retainer MF 4, MF 12, MF 15

L 119 × W 40 × H 83 mm | 0.21 kg

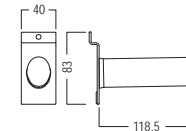

Accessories

octawall 40 classic

Hanging arm

projection 202 mm
for MF 12/MF 15

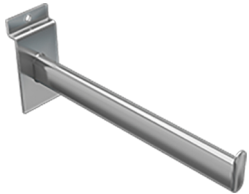

MF 204 S.41

steel, chrome plated

for hooking into wall retainer MF 12 and MF 15, projection 202 mm

L 200 × W 40 × H 83 mm | 0.22 kg

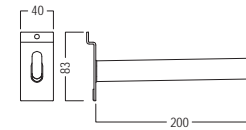

Hanging arm

projection 200 mm
for MF 12/MF 15

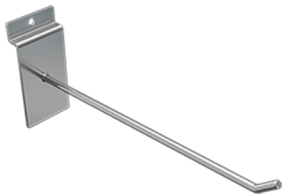

MF 209 S.41

steel, chrome plated

for hooking into wall retainer MF 12 and MF 15, projection 200 mm

L 210 × W 40 × H 85 mm | 0.13 kg

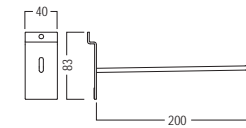

Hanging arm

projection 200 mm
for MF 12/MF 15

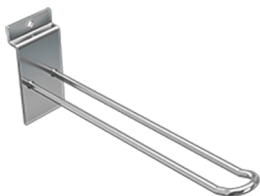

MF 226 S.41

steel, chrome plated

hooking into magnetic retainer MF 12 and MF 15, projection 200 mm

L 210 × W 40 × H 85 mm | 0.126 kg

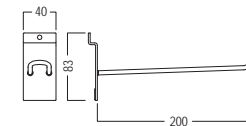

Accessories

octawall 40 classic

Bracket

straight
for MF 12/MF 15

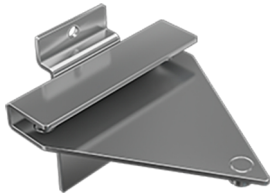

MF 306 S.41

steel, chrome plated

for hooking into magnetic retainer MF 12, MF 15, for 8 mm glass and wooden shelves

L 110 × W 92 × H 83 mm | 0.22 kg

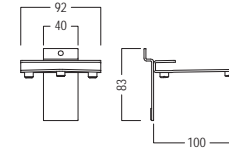

max. projection 200 mm

Shelf

glass, 8 mm
for MF 306 S



MF 125 G.51

acrylic glass transparent

glass, 8 mm, for bracket MF 306 S

L 250 × W 125 × H 8 mm | 0.3 kg

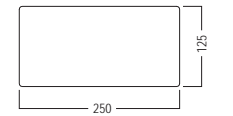

Shelf

glass, 8 mm
for MF 306 S



MF 150 G.51

acrylic glass transparent

glass, 8 mm, for bracket MF 306 S

L 300 × W 150 × H 8 mm | 0.42 kg



Accessories

octawall 40 classic

Shelf

Wood, 8 mm
for MF 306 S



MF 125 P.30

wood, white

wood, 8 mm, for bracket MF 306 S
L 250 × W 125 × H 8 mm | 0.232 kg

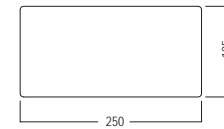

Shelf

Wood, 8 mm
for MF 306 S

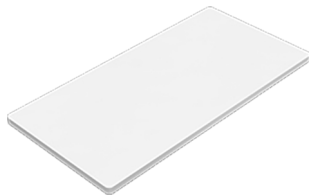

MF 150 P.30

wood, white

Wood, 8 mm, for bracket MF 306 S
L 300 × W 150 × H 8 mm | 0.335 kg

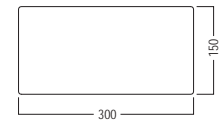

Internal connector

with 2 × Z 961/13
L 62 × W 16 × H 50 mm



Z 910.01

aluminium

beam extrusion Z 402, to be used as shortest connection element
between two extrusions, incl. 2 × built-in tension lock Z 961/13

L 62 × W 16 × H 50 mm | 0.16 kg

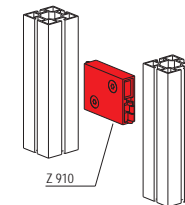
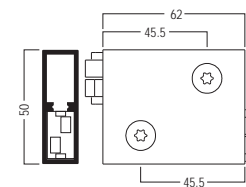

Accessories

octawall 40 classic

Extrusion connector
for system groove 4.3 mm
L 5000 × W 10 × H 10 mm



E 438.30
plastic, semi-hard

for connection of 2 aluminium extrusions in parallel alignment,
suitable for extrusions with a narrow mounting chamber (8.7 mm
min.), for system groove 4.3 mm

L 5000 × W 10 × H 10 mm | 0.277 kg

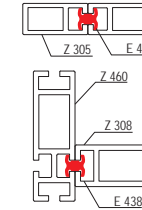

➤ Safety parts

octawall 40 classic

Reinforcing plate

for frame or ceiling element
L 170 × W 200 × H 4 mm

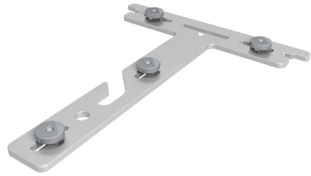

W 466.37

steel

for mounting of riser panel or ceiling element, incl. 4 ×
hammerhead screw E 200 (M5) and 4 × knurled screws W
466-30 (M5)

L 170 × W 200 × H 4 mm | 0.308 kg

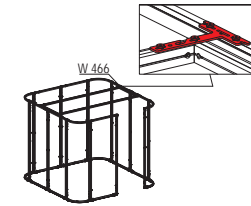
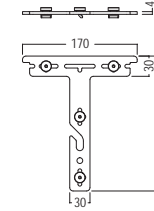

Doors

octawall 40 classic

Sliding door

opening W 950 × H 2500 mm
W 1975 × H 2500 × D 80 mm



W 420.01

aluminium

1 × door element made of W 906 for fabric and panel on both sides, can be attached toolfree to the system groove of the octawall 40 frame with hammer head screws, for installation in opening with clear dimensions W 950 × H 2500 mm, sliding door dimensions W 990 × H 2480 × D 40 mm

W 1975 × H 2500 × D 80 mm | 8.099 kg

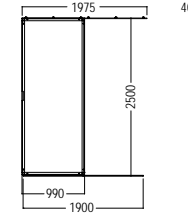

fabric dimension = outer frame dimension

Door

Set
DIN left/right



W 405-SET.01

aluminium/steel

1 × door element made of M 2110/W 906, for fabric/panel on both sides, universal for DIN left and DIN right, opening inwards or outwards, door leaf flush with door leaf frame on the outside or inside, consisting of door leaf frame, outer door frame and door mounting sets, with lock cylinder W 514, without hook tape W 840, outer frame dimension door leaf: 908 × 2442 mm

W 950 × H 2500 × D 40 mm | 15.383 kg

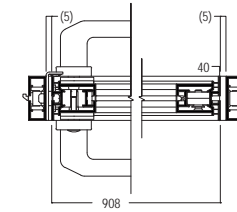
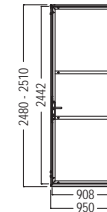

Attention: Only use silicone edge 12 × 3 mm for doorleaf frame!

fabric dimension = outer frame dimension

Window element

for W 805/W405
W 828 × H 2362 × D 40 mm

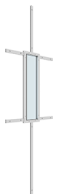

W 809.01

aluminium

1 × window element W 906 for fabric/panel on both sides, for installation in door element W 805, window cut-out: W 200 × H 800 mm

W 828 × H 2362 × D 40 mm | 7.07 kg

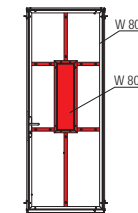
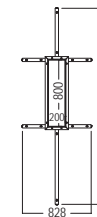

Only use silicone edge 12 × 3 mm for door leaf frame

Doors

octawall 40 classic

Door

Set
DIN left/right



W 425-SET.01

aluminium/steel

1 × door element of M 1305/W 906, for double-sided fabric/panel, universal for DIN left/right, consisting of door leaf frame, door upright frame incl. threshold plate and door roof frame, with hook tape W 840, with dead lock cylinder W 514, outer frame dimension door leaf frame: 855 × 2021 mm, outer frame dimension door frame (top): 870 × 450 mm

W 950 × H 2500 × D 40 mm | 18.722 kg

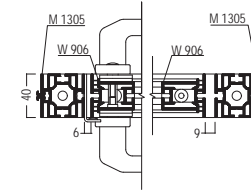
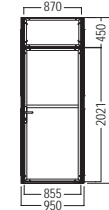

Attention: Only use silicone edge 12 × 3 mm for doorleaf frame!

fabric dimension = outer frame dimension

Door

DIN left/right
40 mm, custom size



W 425SO.01

aluminium/steel

1 × door element of M 1305/W 906, for double-sided fabric/panel, universal for DIN left and DIN right, consisting of door leaf frame, door upright frame and door roof frame, with hook tape W 840, without dead lock cylinder W 514

40 mm, custom size |

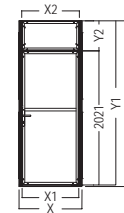

X = 700-1080 mm
X1 = 605-985 mm
X2 = 620-1000 mm

Y = 2400-3000 mm
Y1 = 2380-2980 mm
Y2 = 350-950 mm

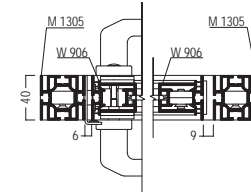

Attention: Only use silicone edge 12 × 3 mm for door leaf frame!

fabric dimension = outer frame dimension

Window element

for door W 425 / W 575
W 775 × H 1941 × D 40 mm



W 414.01

aluminium

1 × window element made of W 906 for double sided fabric/panel, in addition to door element W 425 and W 575, Window size: W 200 × H 800 mm

W 775 × H 1941 × D 40 mm | 4.964 kg

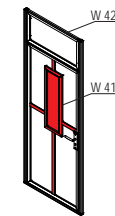
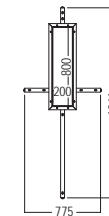

Doors

octawall 40 classic

Door set

for 40/80/120 mm
W 950 × H 2500 × D 40 mm



W 575-SET.01

aluminium/steel

1 × door element made of W 906, for fabric/panel on both sides, DIN left/right, inward/outward opening, incl. doorleafframe, dooruprightframe, threshold plate and door frame (top), hook tape W 840, extrusion connector E 438 and dead lock cylinder W 514, outer frame dimensions: door leaf frame: 855 × 2021 mm, door frame (top): 870 × 450 mm

W 950 × H 2500 × D 40 mm | 18.222 kg

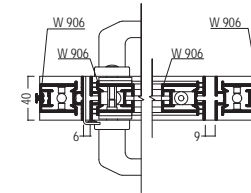
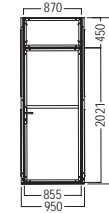

! Only use silicone edge
12 × 3 mm for
doorleafframe

i fabric dimension =
outer frame dimension

Door cylinder

for W 425 / W 575 / W 805
L 61 × W 42 × H 28 mm



W 514.38

steel

1 × dead lock cylinder, for mounting into door W 425 / W 575 / W 805, incl. 3 × key W 514/S

L 61 × W 42 × H 28 mm | 0.222 kg

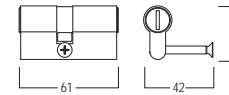

Fabric/Panel/Glass

octawall 40 classic

Silicone edge

100 meter roll
for fabric



M 1313.50

silicone

for mounting fabric to all tension fabric extrusions, 100 m roll
W 14 × H 3 mm | 5.14 kg

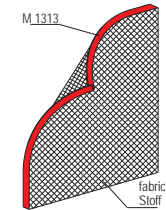
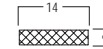

Hook tape

50 meter roll
for mounting of panels



W 840.30

polyamide

for mounting of panels, polyamide, white, self-adhesive, 50 m roll
W 20 × H 2 mm | 0.642 kg

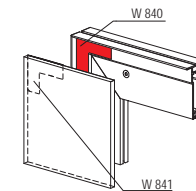
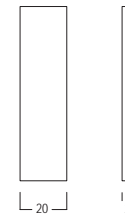

Loop tape

25 meter roll
for mounting of panels



W 841.30

polyamide

for mounting of panels, white, self-adhesive, 25 m roll
W 20 × H 2 mm | 0.391 kg

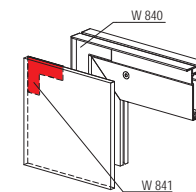

▸ Hinges

octawall 40 classic

Hinged extrusion

90°-180° angle
L 5000 × W 40 × H 40 mm

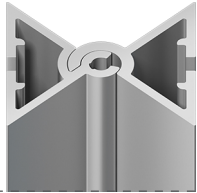

W 908.01

aluminium

two parts, for stepless angle (90°-180°)

L 5000 × W 40 × H 40 mm | 5.602 kg

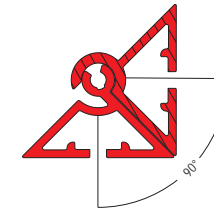
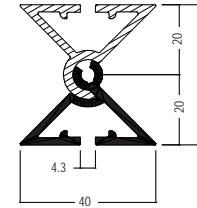

Electrical parts

octawall 40 classic

Wallwasher

LED / 28W / 230V
L 812 x W 166 x H 263 mm



M 1497.31 | .33

aluminium

for uniform illumination of 1000 mm width and 2500 mm height (5700 Kelvin > Cri 90, 3600 lm, 28 W, 125 lm/W), for 230 V power source, for system groove 4.3 mm, space-saving and securely packed, with 16 high-power LEDs, PSU incl. cable (500 mm to lamp and 2500 mm from power supply)

L 812 x W 166 x H 263 mm | 2.041 kg

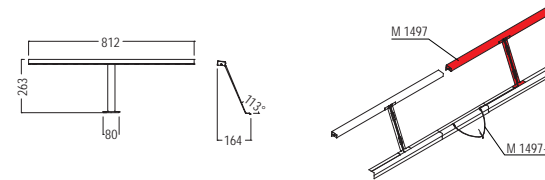

Hanging lamp

LED / 56W / 230V
L 818 x W 150 x H 35 mm



M 1497-H.33

aluminium, matt powder-coated

for a homogenous illumination in 5700K > Cri 90, with 32 highpower LEDs, 7200 lm, 56 W, 128 lm/W, for 230 V, incl. 3.5 m wire rope with 2 x Reutlinger wire rope holders to adjust height, 2 x plastic end caps black, 1 x power supply unit incl. DC distributor, 3 m extension cable with DC connector

L 818 x W 150 x H 35 mm | 2.49 kg

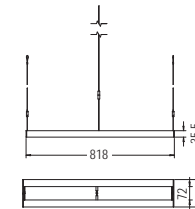

Power supply

for wallwasher M 1497
L 1175 x W 72 x H 35 mm

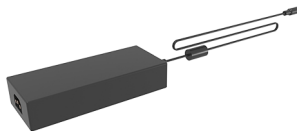

M 1497-11.90

plastic

for wallwasher M 1497, converter with 24V, 6.67A, 160W, rated voltage AC 100-240V, 50/60Hz, cable 1000 mm long

L 1175 x W 72 x H 35 mm | 0.638 kg

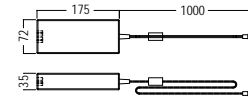

Attention: suitable power cord M 1497-12 is required

Electrical parts

octawall 40 classic

Cable

for wallwasher M 1497
2500 mm long

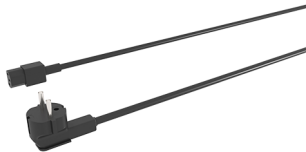

M 1497-12.90

plastic, black

for wallwasher M 1497, power cord CEE 7/7 - C13
2500 mm long | 0.259 kg

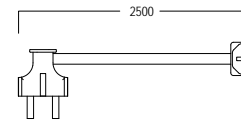

Extension cable

for wallwasher M 1497
3000 mm long



M 1497-1.33

plastic, black

cable for connecting M 1497 wallwashers, with angled barrel
connector at both ends
3000 mm long | 0.128 kg

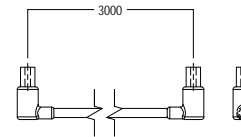

PWM Dimmer

for wallwasher M 1497
L 150 x W 40 x H 20 mm



M 1497-4.90

plastic

1 x control unit and remote control for dimming of max. 5
wallwasher M 1497, DC 12-24 V, 2.4 GHz, PWM frequency 1.95 KHz
L 150 x W 40 x H 20 mm | 0.103 kg

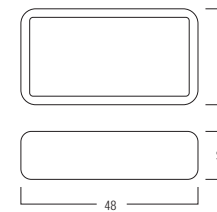

Electrical parts

octawall 40 classic

Cable

Y-Splitter for wallwasher M 1497



M 1497-3.90

plastic, black

Y-cable for connecting up to 5 x wallwasher M 1497, with barrel connector at all ends

300 mm long | 0.041 kg

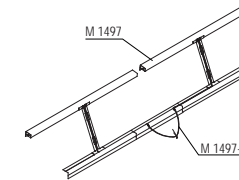
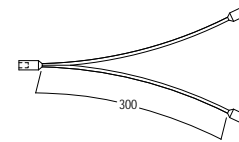

Long-arm floodlight

25 W L 490 x W 232 x H 40 mm



M 1494.31 | .33

aluminium

for swivel mounting in system groove, incl. adapter plate and connection cable 3 m, 25 W, 2500 lm, 4000 K, voltage input: 100-240 VAC, voltage output: 27-35 VDC, color rendering index: 80+ CRI, beam angle: 120°, up to 10 floodlights can be connected in series

L 490 x W 232 x H 40 mm | 0.76 kg

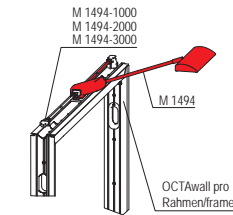
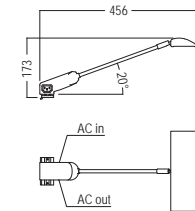

**without connecting
cable M 1494-xxxx**

Connecting cable

for M 1494 1000 mm long



M 1494-1000.33

rubber

230V connecting cable for IEC C13 connections, one side plug, one side socket, can also be used as an extension

1000 mm long | 0.115 kg

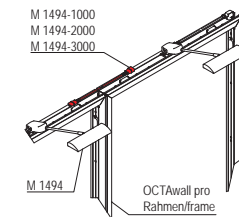
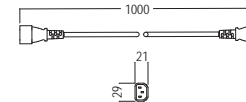

Electrical parts

octawall 40 classic

Connecting cable

for M 1494
2000 mm long

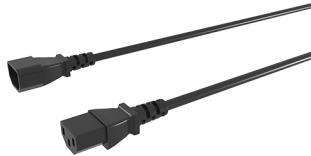

M 1494-2000.33

rubber

230V connecting cable for IEC C13 connections, one side plug, one side socket, can also be used as an extension

2000 mm long | 0.23 kg

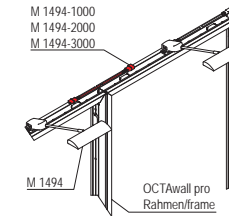
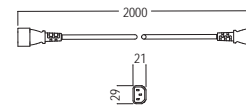

Connecting cable

for M 1494
3000 mm long

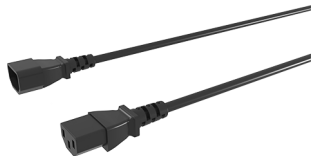

M 1494-3000.33

rubber

230V connecting cable for IEC C13 connections, one side plug, one side socket, can also be used as an extension

3000 mm long | 0.35 kg

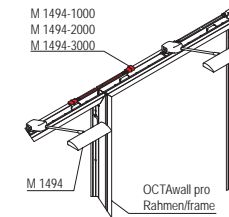
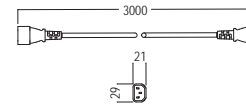

Retainer

for long-arm floodlight M 1498
L 26 x W 35 x H 16 mm

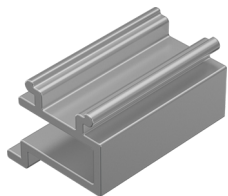

M 1481.01

aluminium

for installation in 4.3 mm system groove (extrusion top face) can be used in combination with long-arm spot light M 1480 / M 1499

L 26 x W 35 x H 16 mm | 0.014 kg

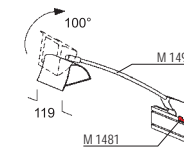
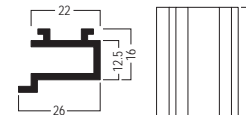

Electrical parts

octawall 40 classic

Cable retaining

small
for system groove 4.3 mm



E 460.35

plastic, semi-hard

small, for mounting of cables to system groove
L 5000 × W 16 × H 20 mm | 0.73 kg

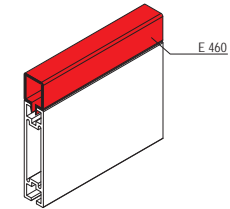
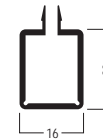

Cable protection

for extrusion M 1307
L 52 × W 9 × H 40 mm



W 995.35

plastic

for extrusion M 1307, to protect cables from damage during installation, for cables without plug, installation in octawall 40 frames

L 52 × W 9 × H 40 mm | 0.01 kg

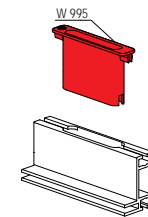
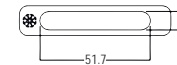

Cable protection

for extrusion W 906
L 52 × W 17 × H 24 mm



W 996.35

plastic

to protect cables from damage during installation, for cables with plug, installation in octawall 60 frames

L 52 × W 17 × H 24 mm | 0.007 kg

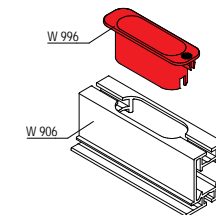
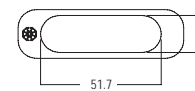
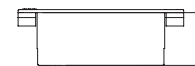

➤ Packing/Transport

octawall 40 classic

Transport bag

for 2 × M 1951 / M 1953
L 620 × W 50 × H 270 mm



W 927.90

nylon, blue

for 2 × foot plate M 1951 or M 1953, with inner partition
L 620 × W 50 × H 270 mm | 2.2 kg

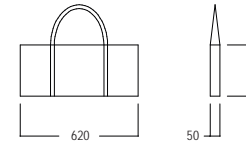

Distance piece

for octawall frames
L 51.5 × W 51.5 × H 14 mm

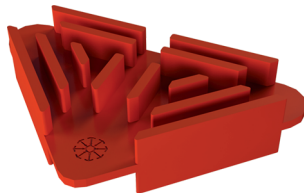

W 1000.90

plastic, red

to fix frames during packaging, storage and transport, suitable for
all octawall frame systems
L 51.5 × W 51.5 × H 14 mm | 0.009 kg

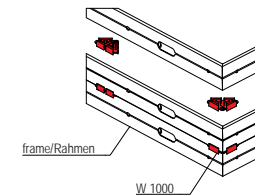
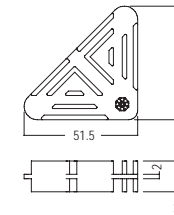

Pallet

for frames W 950 mm
L 2550 × W 1010 × H 125 mm



W 2020-P.90

wood

Packing, storing and transport, suitable for all octawall frames
width 950 mm
L 2550 × W 1010 × H 125 mm | 31 kg

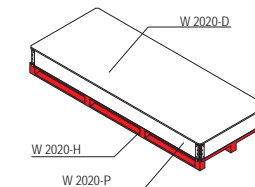
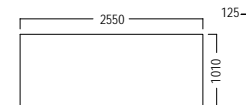

➤ Packing/Transport

octawall 40 classic

Stacking frame

for frames W 950 mm
L 2550 × W 1050 × H 200 mm



W 2020-H.90

wood/steel

Packing, storing and transport, suitable for all octawall frames width 950 mm

L 2550 × W 1050 × H 200 mm | 13.8 kg

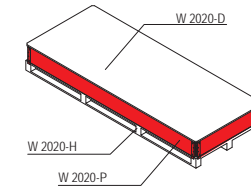
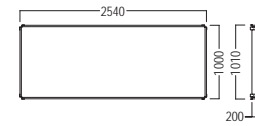

Stacking frame cover

for frames W 950 mm
L 2550 × W 1050 × H 15 mm



W 2020-D.90

wood

Packing, storing and transport, suitable for all octawall frames width 950 mm

L 2550 × W 1050 × H 15 mm | 14.5 kg

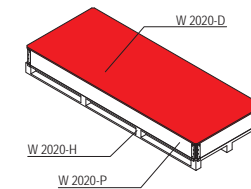
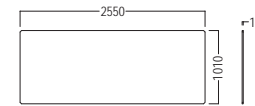

➤ technical information

➤ M-OW-1.2	49
octawall 40 Mounting of door	
➤ TI-M-66.0	50
Base Plate / M1951, M 1952, M 1953	
➤ TI-M-71.0	51
Fabric size door leaf frame for W 575/ W 425/ W 415 including W 414	
➤ TI-MBOW-W 420A0	52
octawall 40 Fabric and Panel Dimensions, Sliding Door W 420	
➤ TI-MBOW-W 420A1	53
octawall 40, Sliding Door W 420 with octawall 40 or octawall pro	
➤ TI-MBOW-W 420A2	54
octawall 40, Sliding Door Element W 420, 950 x 2500 mm	
➤ TI-MBOW-W 420A2HL	55
octawall 40, Sliding Door Element W 420, 950 x 2500 mm	
➤ TI-MBOW-W 420A2HR	56
octawall 40, Sliding Door Element W 420, 950 x 2500 mm	
➤ TI-MBOW-W 420A2VL	57
octawall 40, Sliding Door Element W 420, 950 x 2500 mm	
➤ TI-MBOW-W 420A2VR	58
octawall 40, Sliding Door Element W 420, 950 x 2500 mm	
➤ TI-MBOW-W 420A4	59
octawall 40, Sliding Door Element W 420, 950 x 2500 mm	

➤ technical information

➤ TI-MBOW-W 420A5	60
octawall 40, Sliding Door Element W 420, 950 x 2500 mm	
➤ TI-OW-10.0	61
octawall 40 fabric, seamless graphic	
➤ TI-OW-10.1	62
octawall 40 fabric, seamless graphic frame type	
➤ TI-OW-12.2	63
octawall 40 classic cable outlet	
➤ TI-OW-20.0	64
octawall 40 classic cubicle 3 x 3 m	
➤ TI-OW-21.0	65
octawall 40 classic W 441E frame element curved 495mm	
➤ TI-OW-21.1	66
octawall 40 classic panel W 441E frame element curved 495mm	
➤ TI-OW-3.1	67
octawall 40 - Loop Tape Requirements for panel + panel size	
➤ TI-OW-3.2	68
octawall 40 classic, corner extrusion S 382/S381 fabric dimensions	
➤ TI-OW-3.3	69
W 840 / W 841 Hook and loo tape notes	
➤ TI-OW-5.0	70
octawall 40, Extrusion for Bracing and Connecting to Ceiling	

➤ technical information

➤ TI-WW-1.0	71
M1497 Wallwasher Technical Data	
➤ TI-WW-2.0	72
M1497 Installation in the system groove	
➤ TI-WW-2.1	75
M1497 Wiring of up to 5 wallwashers	
➤ TI-WW-3.0	76
M 1497-H Wallwasher Hanging Lamp	
➤ TI-WW-4.0	80
M 1497 Wallwasher data sheet and assembly	
➤ TI-WW-4.1	85
M 1497-4 Dimmer Wallwasher User Manual	

door installation - lock on upright

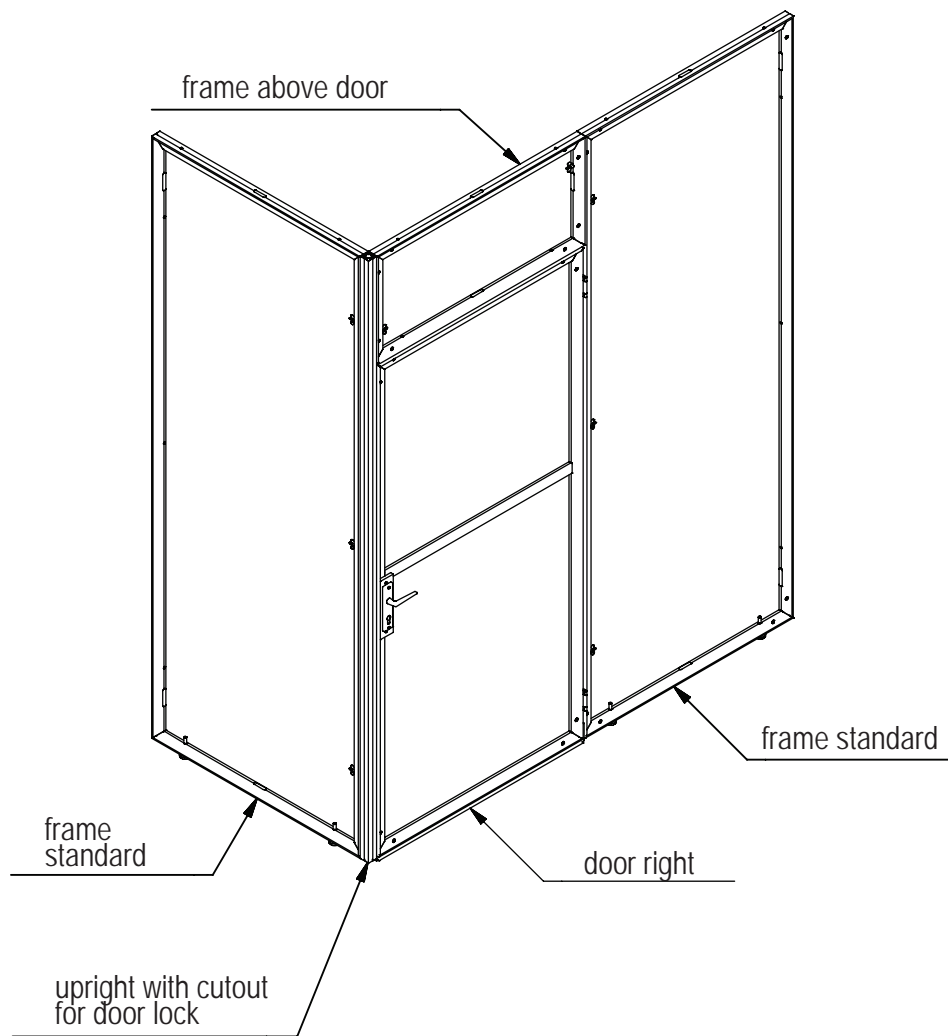

door installation - door hinge on upright

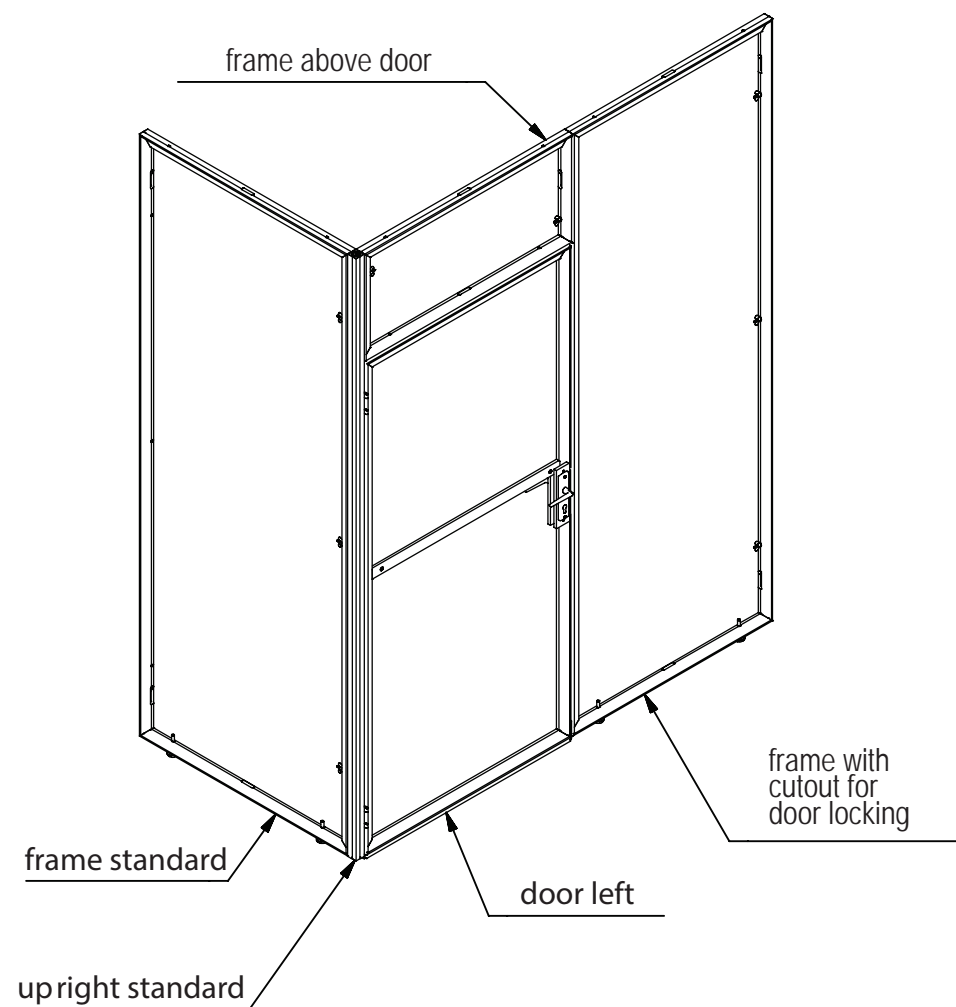

M-OW-1.2 E-000408-0034A-T01 In Arbeit 30.08.2012 RE / geä. 07. 02.2013 RE - 02/2013 shift

Assembly of base plates: M 1941, M 1942, M 1943

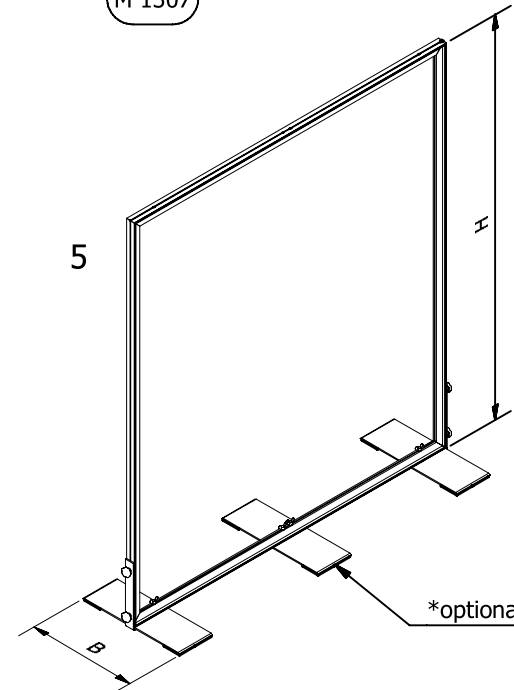
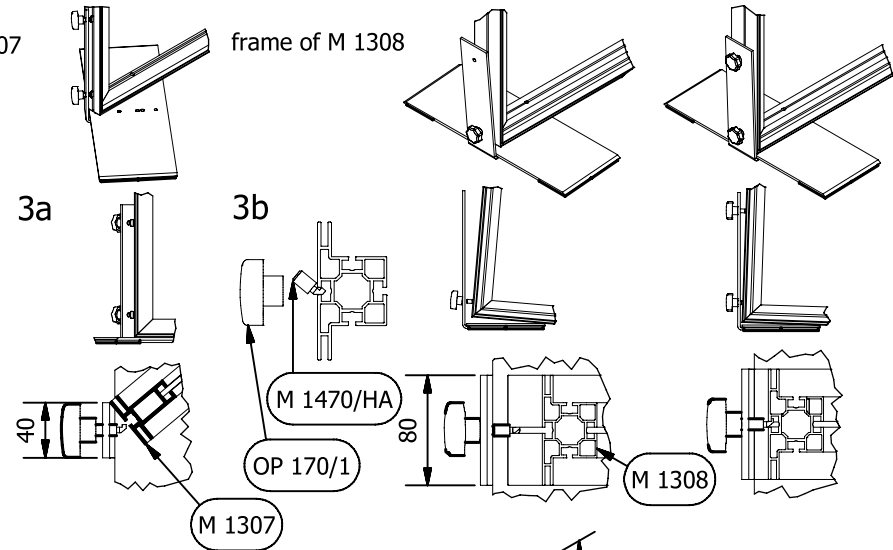
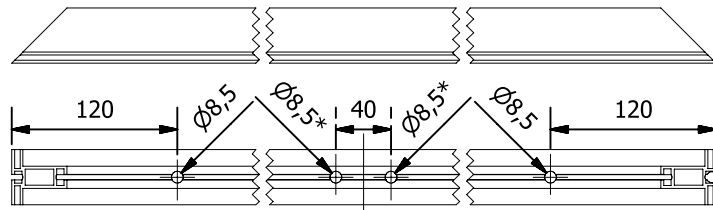
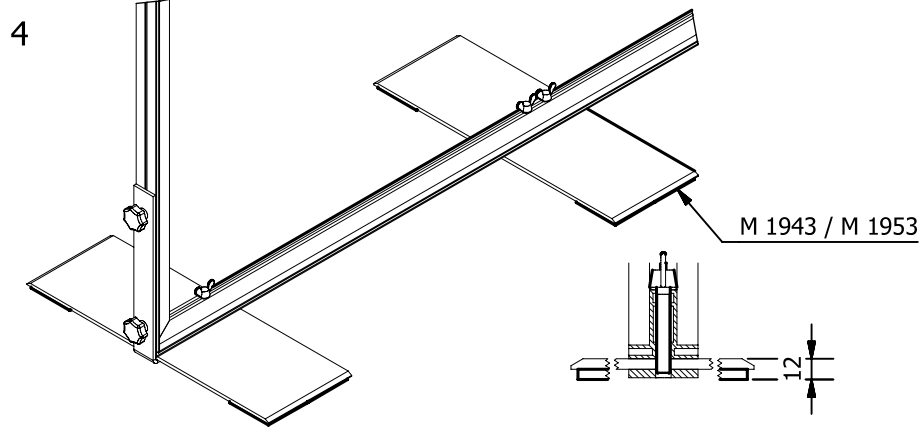
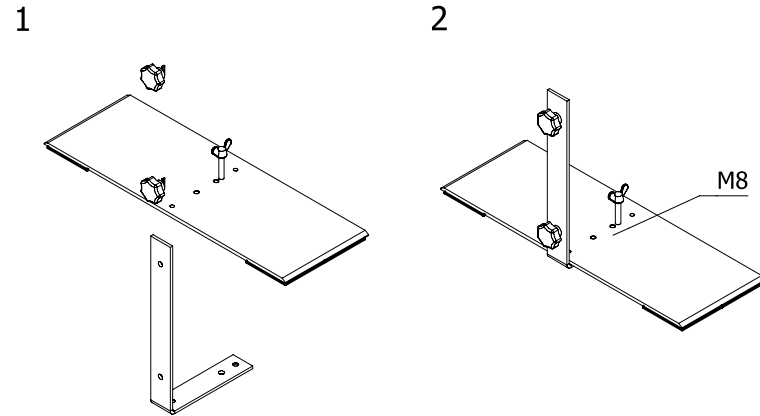

H	B
2000	495
2500	600

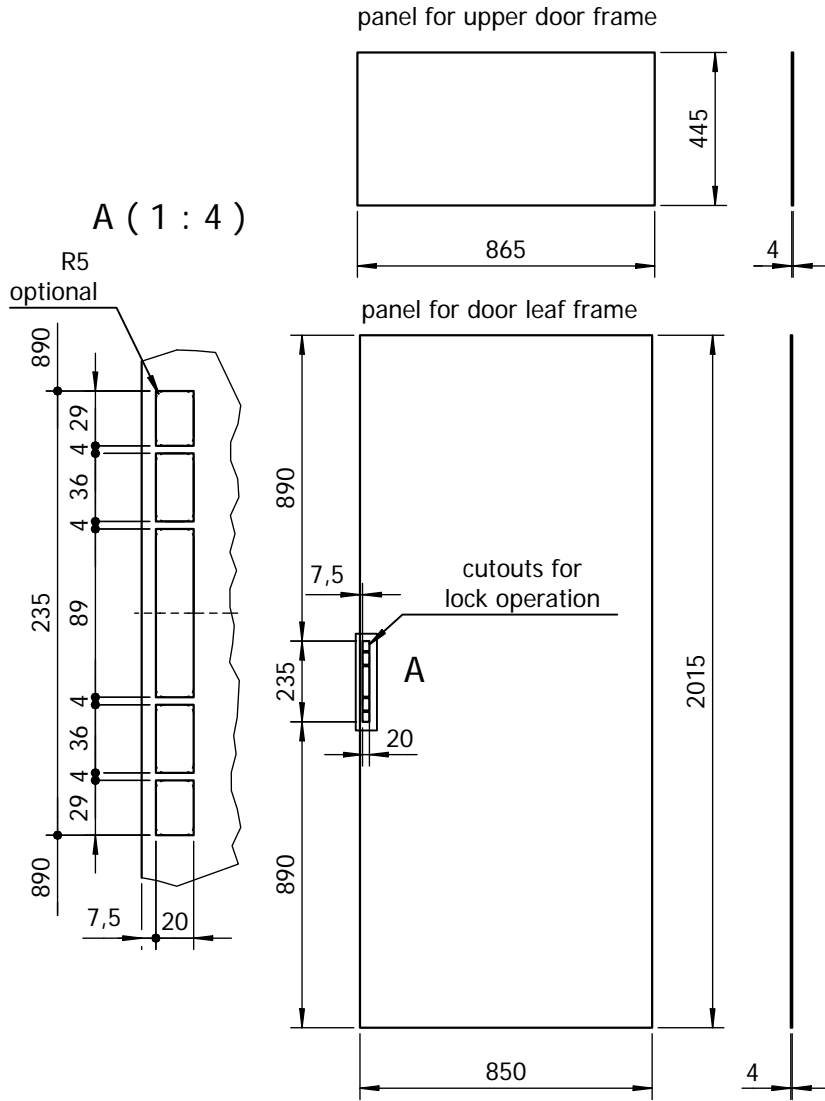

Fabric dimensions
 Outer dimensions door leaf frame: 2021 x 855
(ATTENTION: Use flat silicone welt 12x3mm for door leaf frame!)
 Outer dimensions upper door frame: 450 x 870

Panel dimensions
 Outer dimensions door leaf frame: 2015 x 850
 (see drawing)
 Outer dimensions upper door frame: 445 x 865

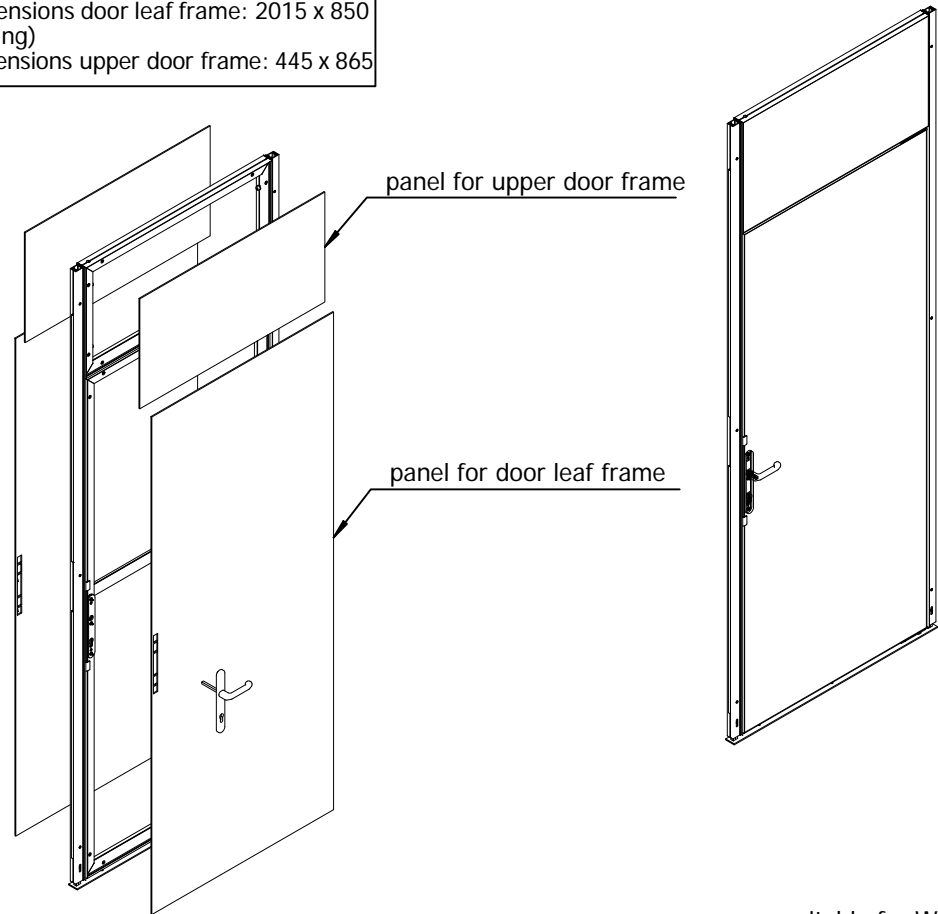

suitable for W 575

TIM71.0.D-T00643-0300C E-000643-0300A-T02 A.1.2 Freigegeben 24.04.2020 ED

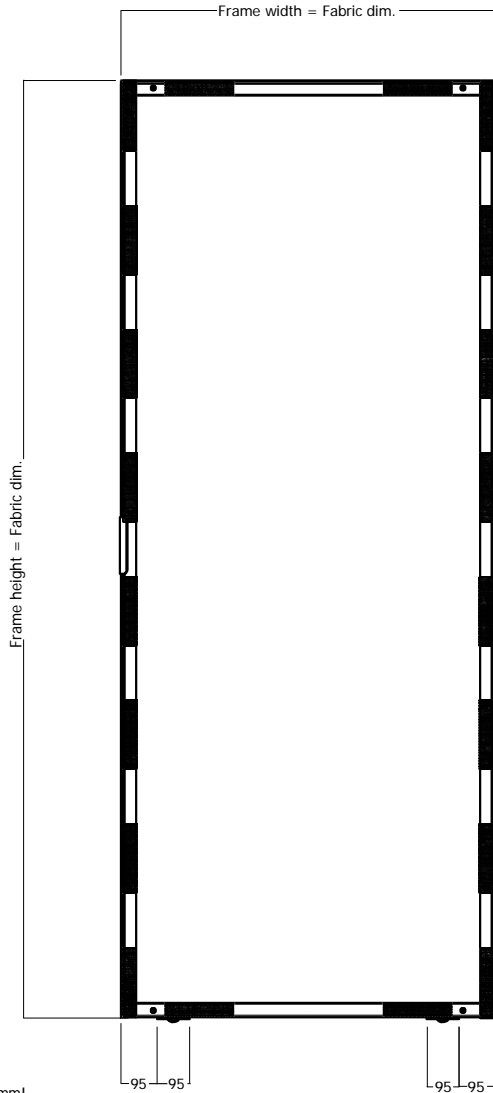

All dimensions in mm!
The drawing remains basically valid!

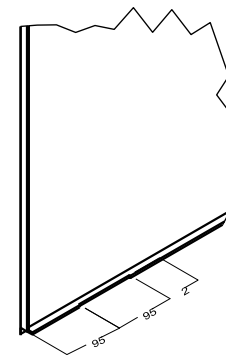
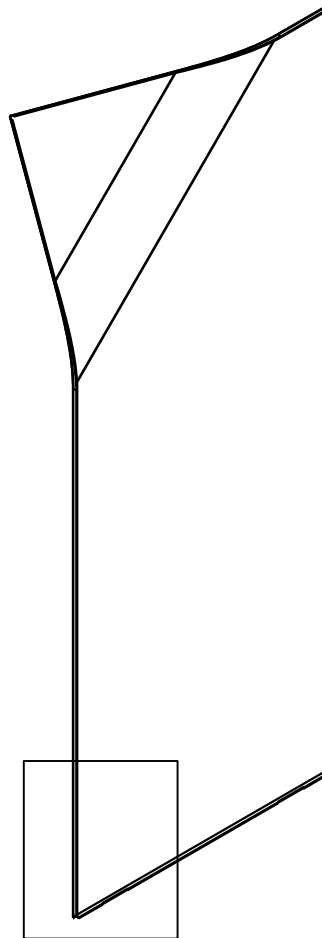

**A silicone edge of 12 x 3 mm must be used for the fabric.
It must be cut out at the positions of the rollers, see the drawing.**

Panel Dimensions

Width: frame width - 5 mm (calculated 1 mm air gap)
Height: frame height - 6 mm (calculated 2 mm air gap)

E.g.: loop tape requirements (mm)	
	H: 2480
W: 990	7400

* The indicated loop tape lengths are also valid for similar frame dimensions.

The "loop tape requirement" is calculated for double-sided paneling of the frame.

Fabric Dimensions

Width: frame width
Height: frame height

Installation of W 420 sliding door in an octawall pro wall (suitable for octawall pro frames from a width of 950 mm to opening side)

octawall pro

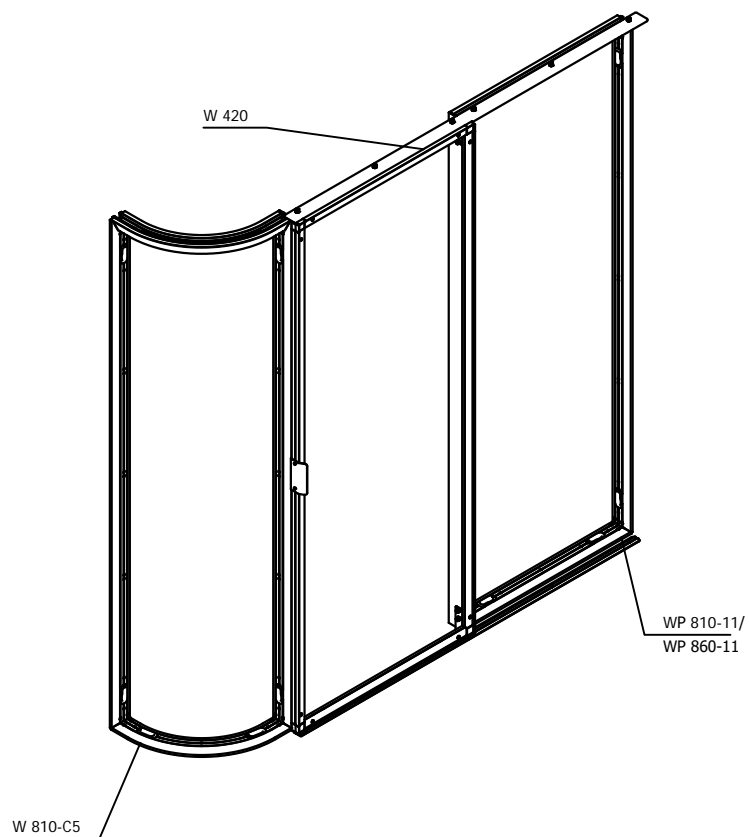

The W 420 sliding door is installed using OL 252 fixing sets. These are on the floor rail W 420-8, the ceiling rail W 420-9 and the guide rail W 420-7 and are mounted in the grooves of the surrounding frames.

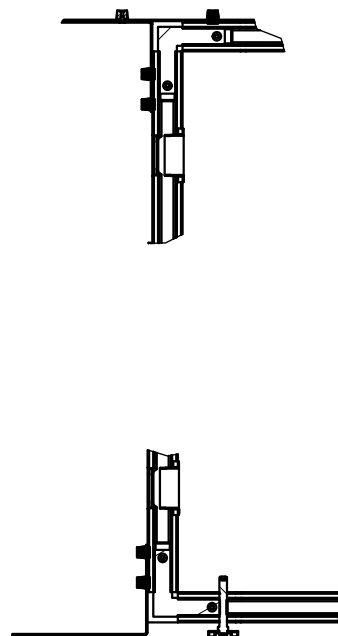

Installation of W 420 sliding door in an octawall 40 wall (suitable for octawall 40 frames from a width of 950 mm to opening side)

octawall 40

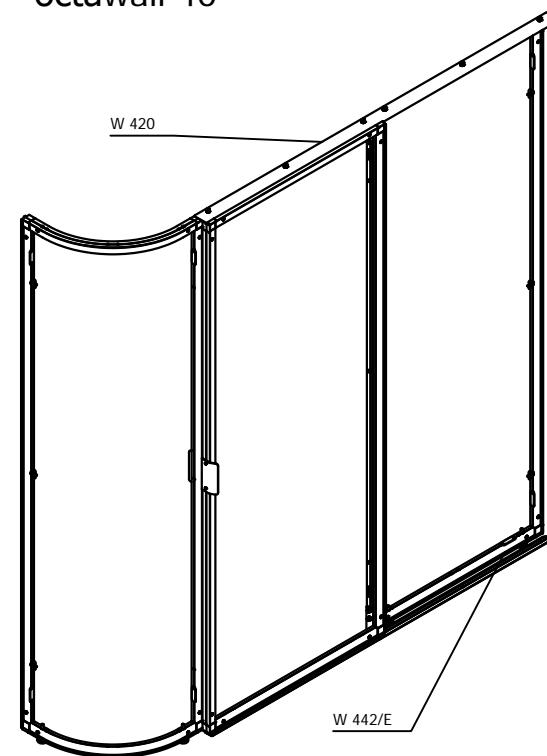

The W 420 sliding door can be used in 4 different ways: inside, outside, and opening to the right or left.

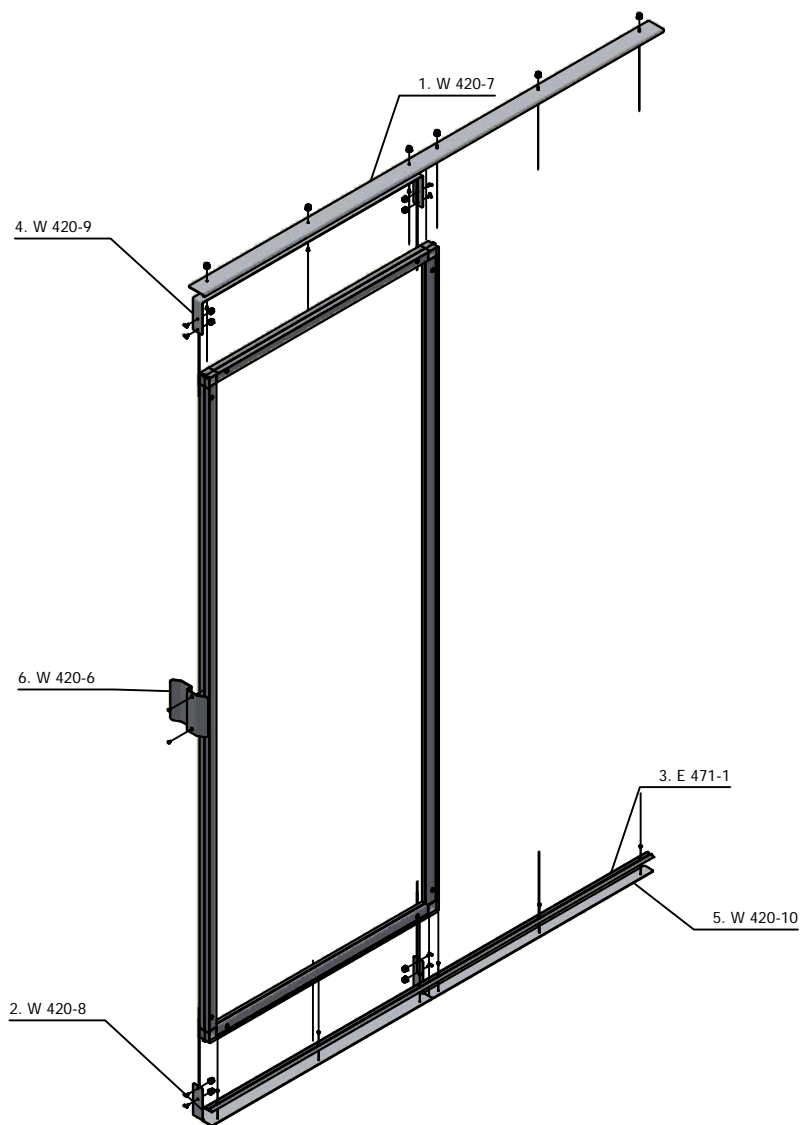

W 420 is a universal sliding door that can be installed in an octawall 40 wall. The door can be installed in 4 different positions, depending on requirements. For this purpose, the door's guide has a modular design. Due to this modular design, the door can be opened to the left or to the right and can be installed either in front of or behind the wall.

The guide consists of the following parts:

1. guide rail W 420-7
2. floor rail W 420-8
3. runner extrusion E 471-1
4. ceiling rail W 420-9
5. bottom plate W 420-10
6. sliding door handle W 420-6

With different arrangement of these parts, the sliding door can be installed in the following mounting variants:

Variant 1: Sliding door opening in front of the wall. Door stop on the right.

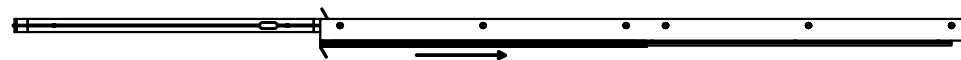

Variant 2: Sliding door opening in front of the wall. Door stop on the left.

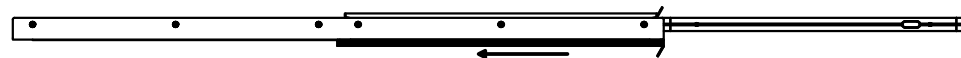

Variant 3: Sliding door opening behind the wall. Door stop on the left.

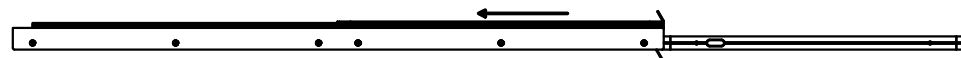

Variant 4: Sliding door opening behind the wall. Door stop on the right.

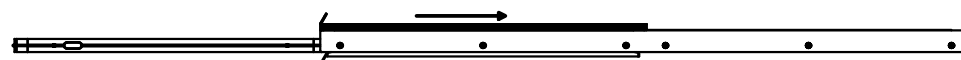

Variant 3: Sliding door opening behind the wall. Door stop on the left.

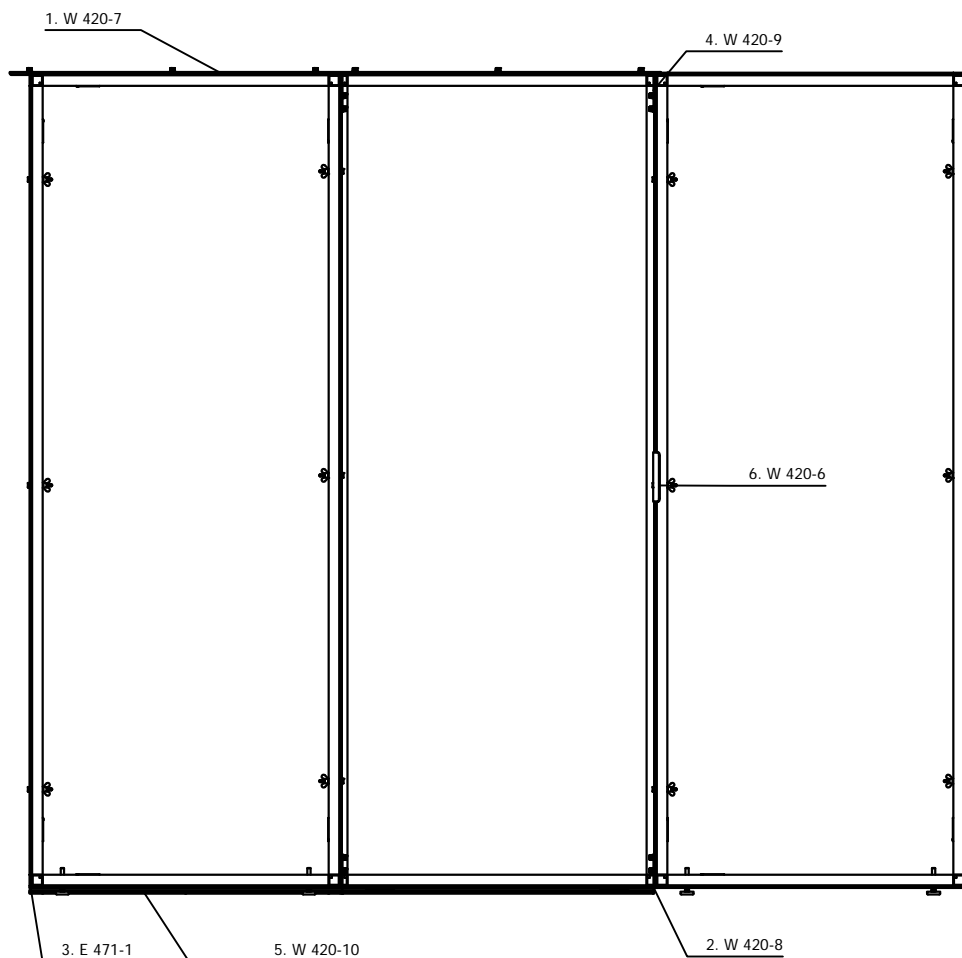
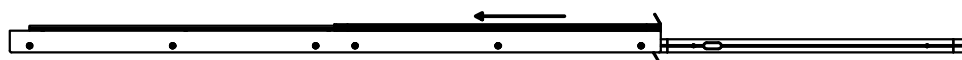

Installation as sliding door opening behind the wall. Door stop on the left.

The guide consists of the following parts:

1. guide rail W 420-7
2. floor rail W 420-8
3. runner extrusion E 471-1
4. ceiling rail W 420-9
5. bottom plate W 420-10
6. sliding door handle W 420-6

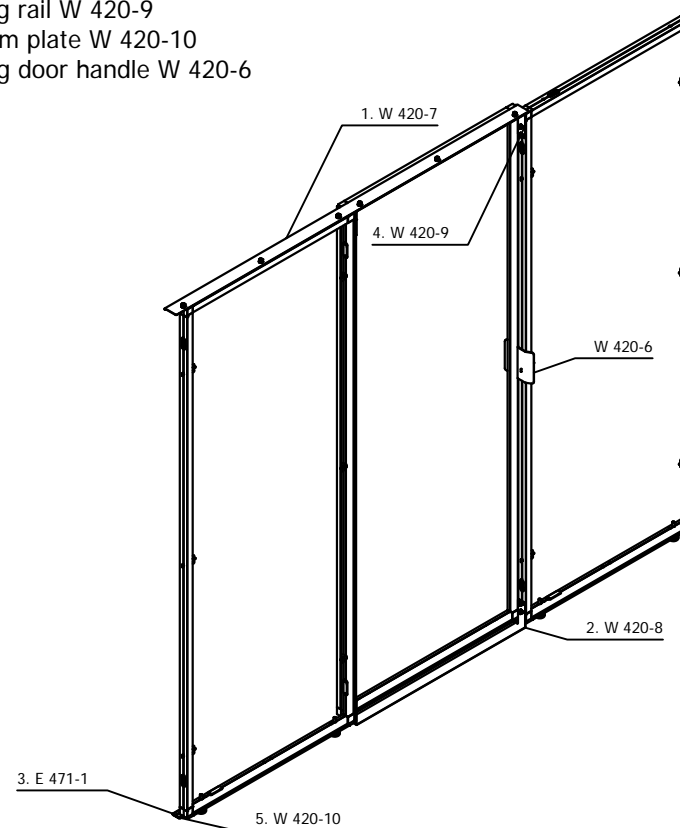

Variant 4: Sliding door opening behind the wall. Door stop on the right.

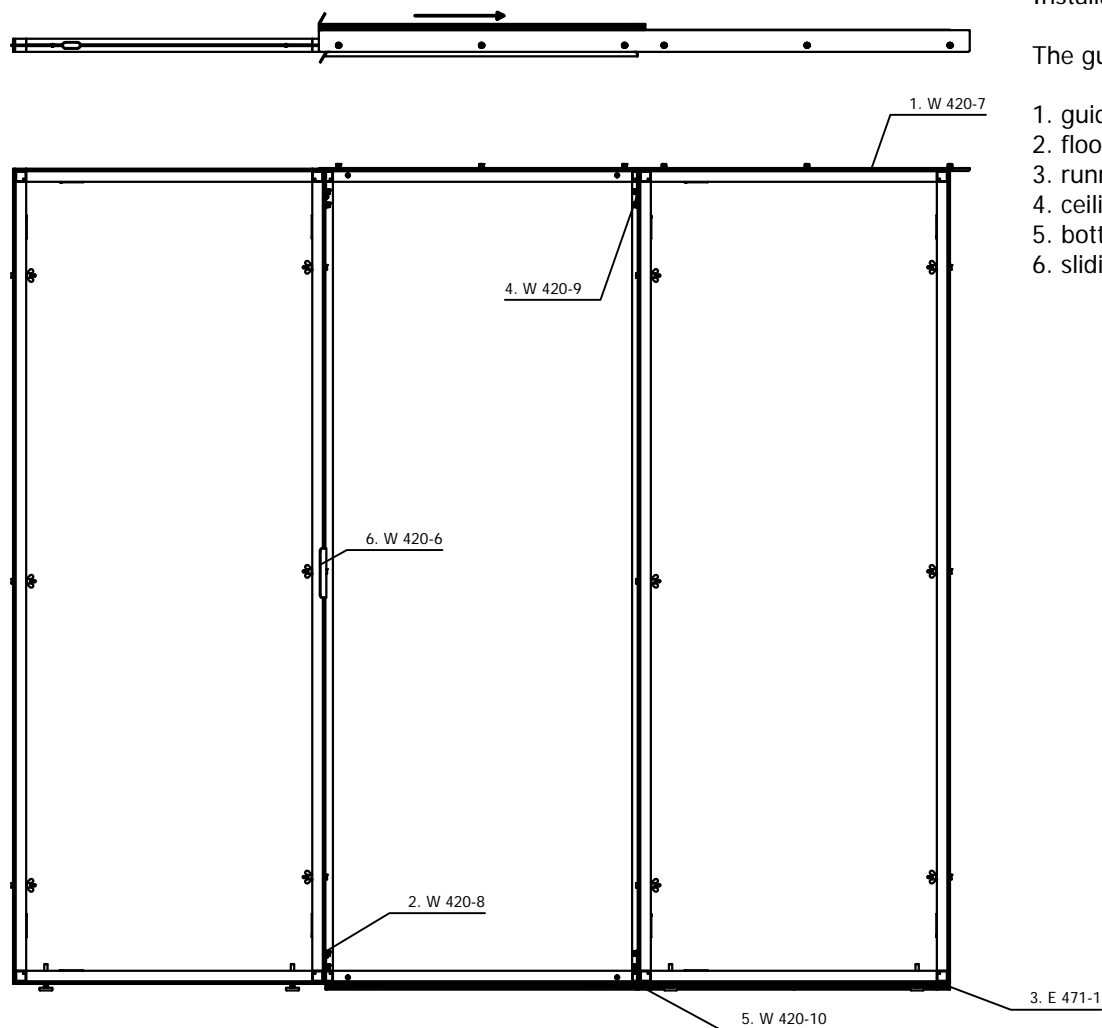

Installation as sliding door opening behind the wall. Door stop on the right.

The guide consists of the following parts:

1. guide rail W 420-7
2. floor rail W 420-8
3. runner extrusion E 471-1
4. ceiling rail W 420-9
5. bottom plate W 420-10
6. sliding door handle W 420-6

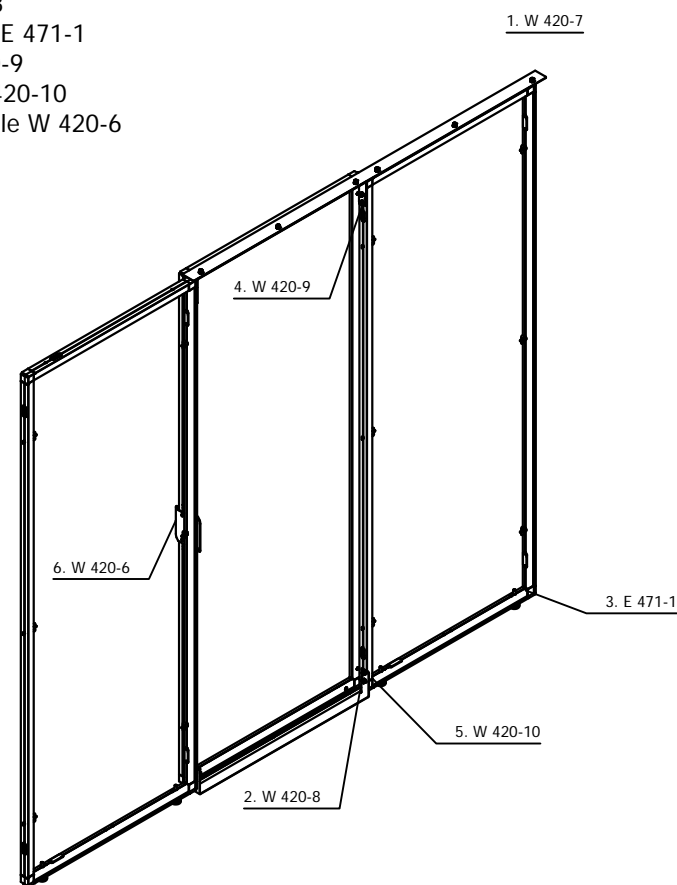

Variante 2: Sliding door opening in front of the wall. Door stop on the left.

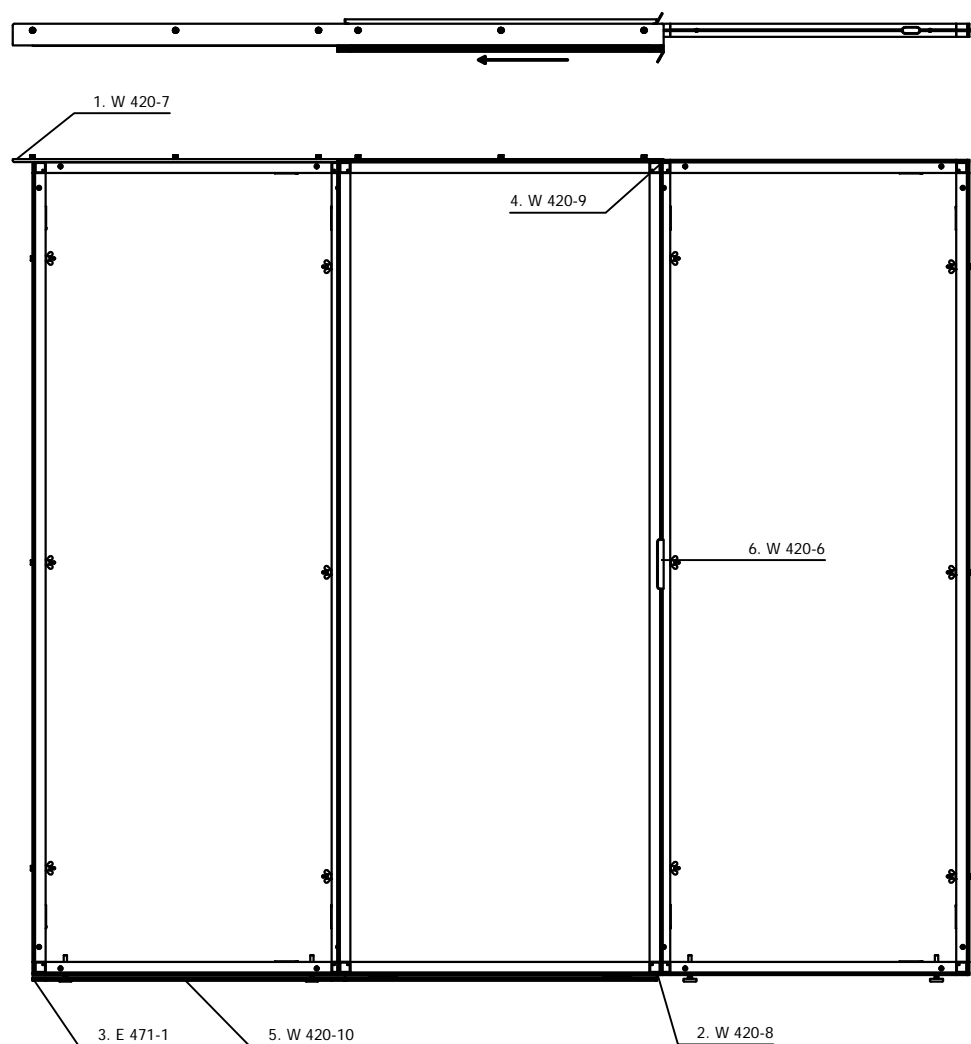

Installation as sliding door opening in front of the wall. Door stop on the left.

The guide consists of the following parts:

1. guide rail W 420-7
2. floor rail W 420-8
3. runner extrusion E 471-1
4. ceiling rail W 420-9
5. bottom plate W 420-10
6. sliding door handle W 420-6

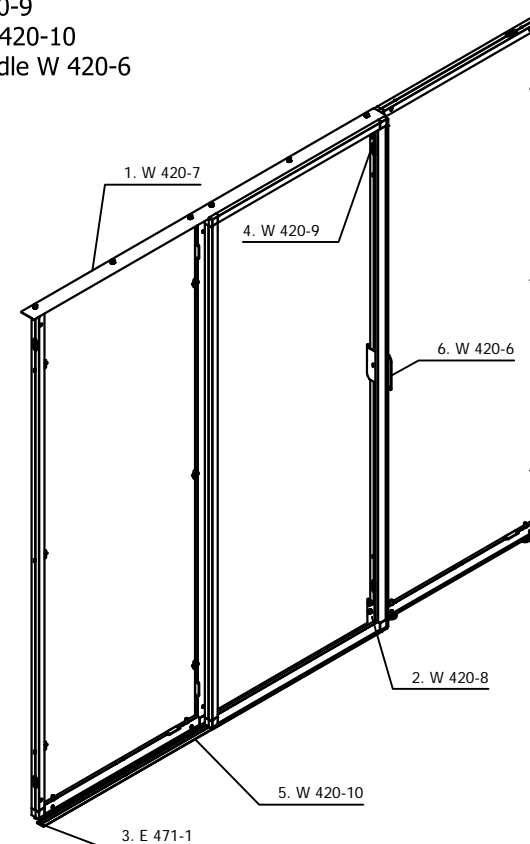

Variante 1: Sliding door opening in front of the wall. Door stop on the right.

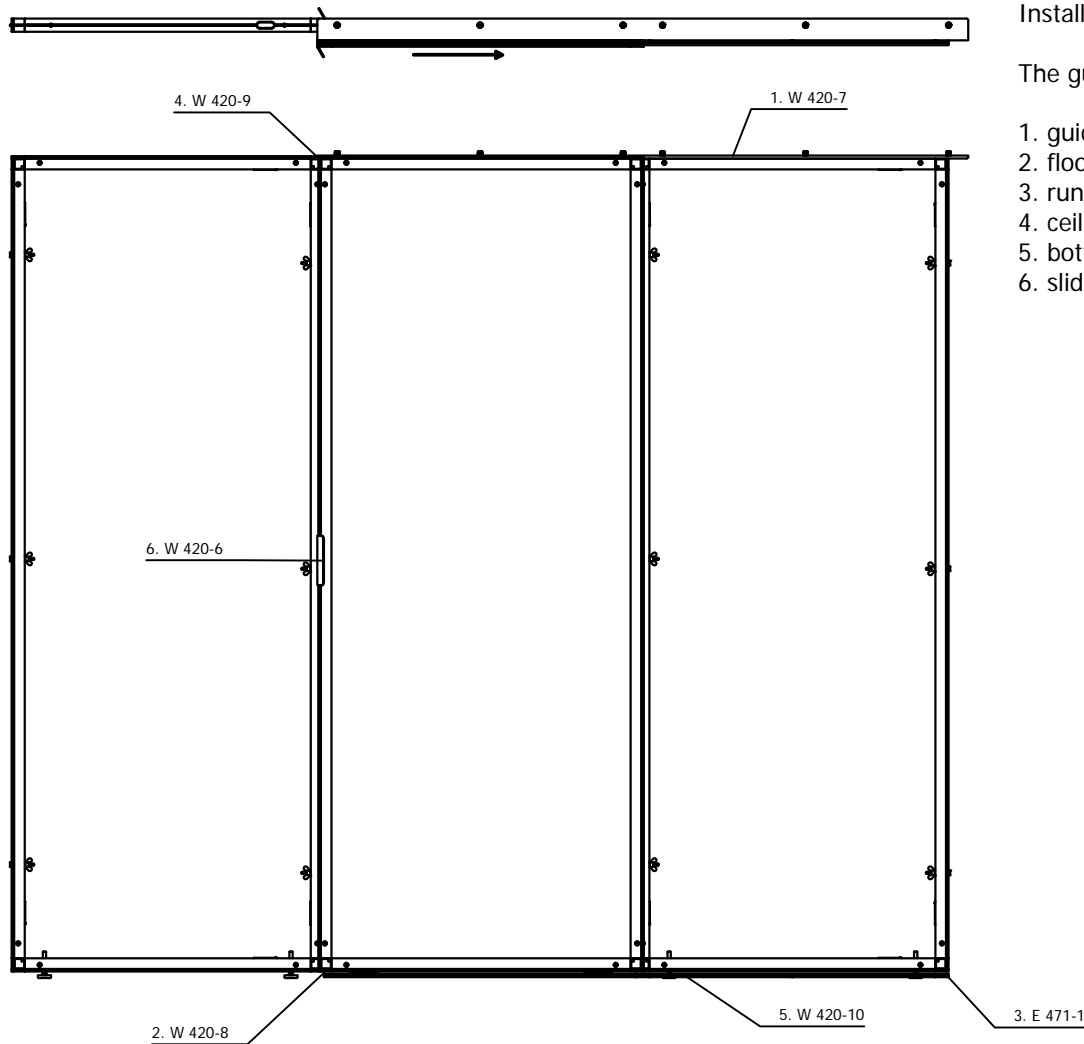

Installation as sliding door opening in front of the wall. Door stop on the right.

The guide consists of the following parts:

1. guide rail W 420-7
2. floor rail W 420-8
3. runner extrusion E 471-1
4. ceiling rail W 420-9
5. bottom plate W 420-10
6. sliding door handle W 420-6

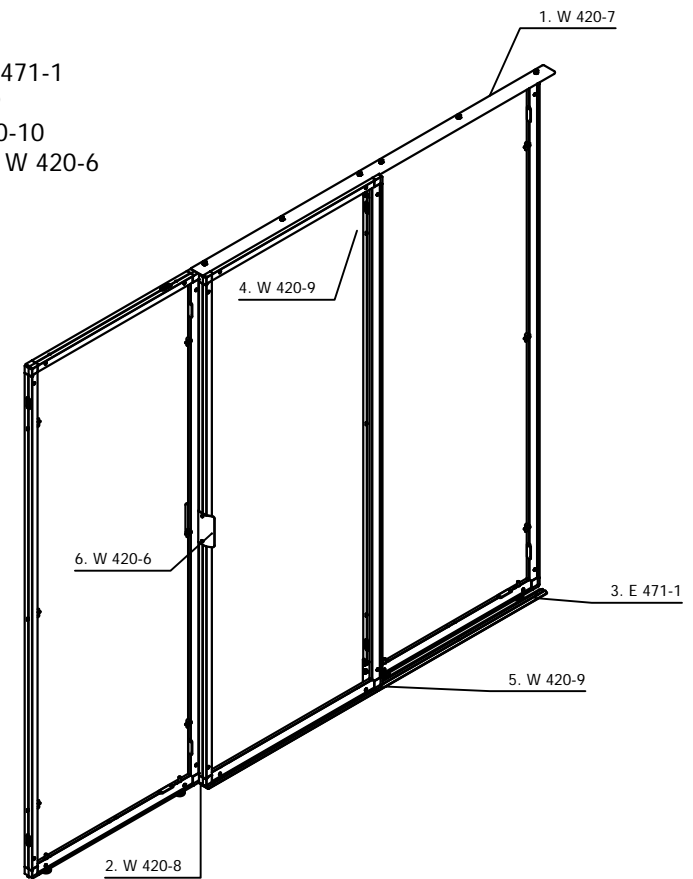

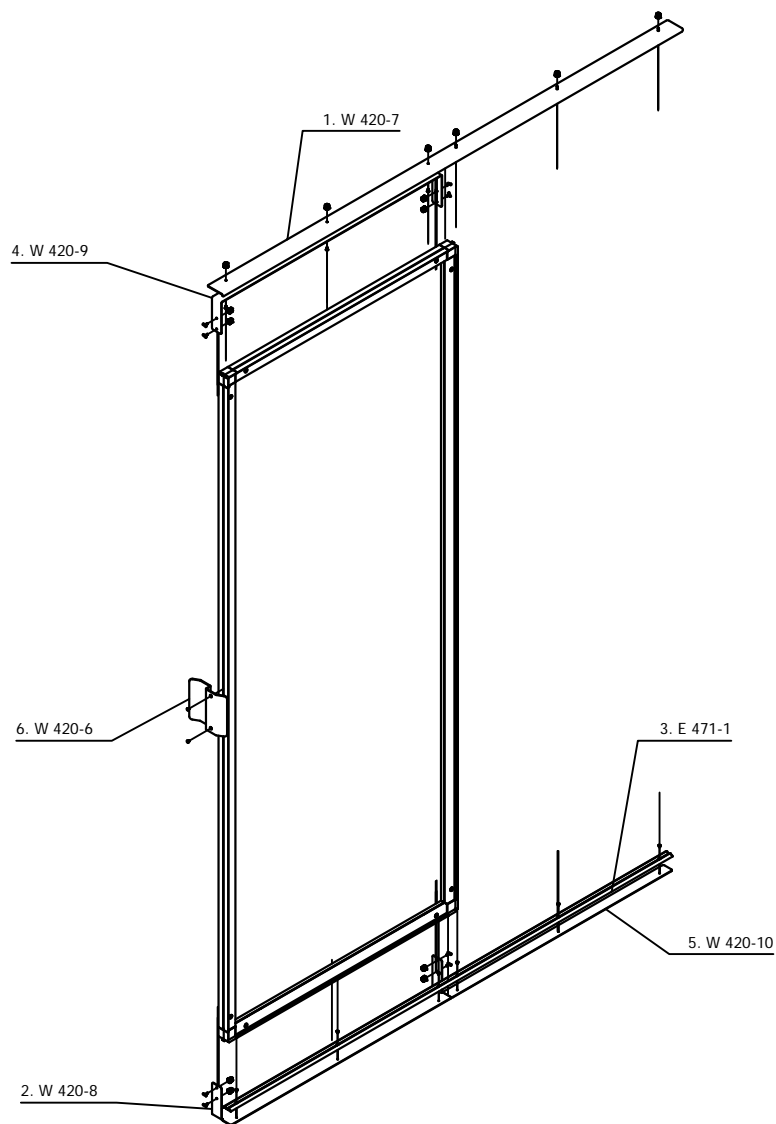

Mounting of the guide rail W 420-7 with ceiling rail W 420-9.

The guide rail W 420-7 is screwed to the ceiling rail W 420-9 with 3 screws DIN 7991 M4x8 and 3 knurled nuts OL 252.

The ceiling rail W 420-9 can be screwed to the guide rail W 420-7 in two different positions.

Position 1: for variants 2 and 4

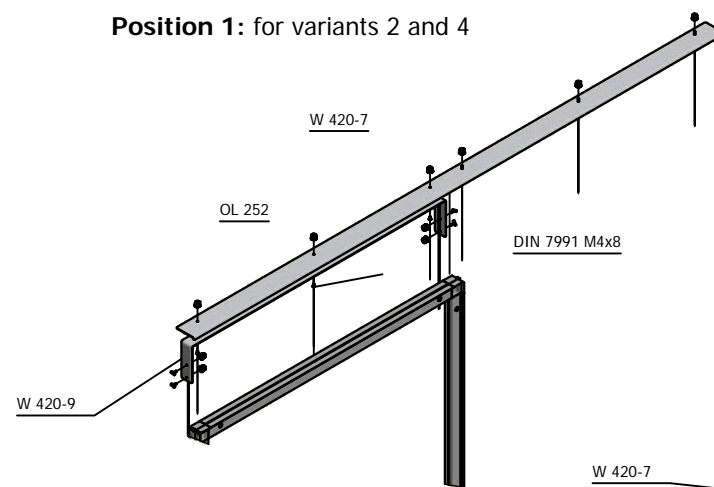

Position 2: for variants 1 and 3

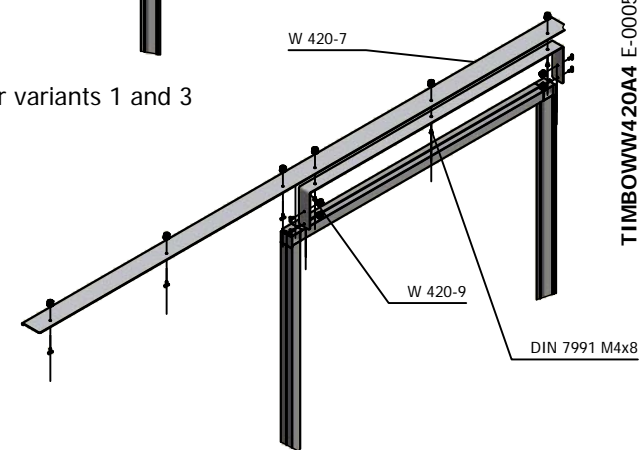

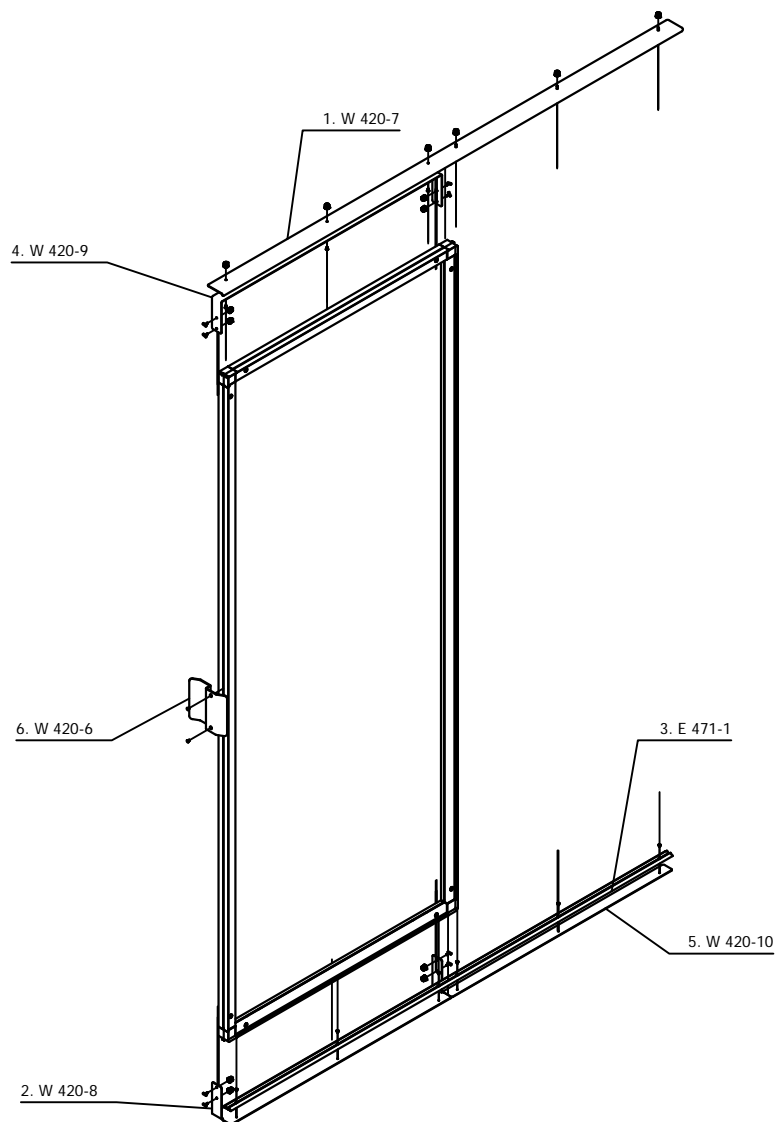

Mounting of bottom rail W 420-8 and bottom plate W 420-10 with runner extrusion E 471-1.

The bottom rail W 420-8 and the bottom plate W 420-10 are screwed to the E 471-1 runner extrusion with 6 DIN 7991 M4x6 screws.

The bottom rail W 420-8 and the bottom plate W 420-10 can be screwed to the E 471-1 runner profile in two different positions.

Position 1: for variants 2 and 4

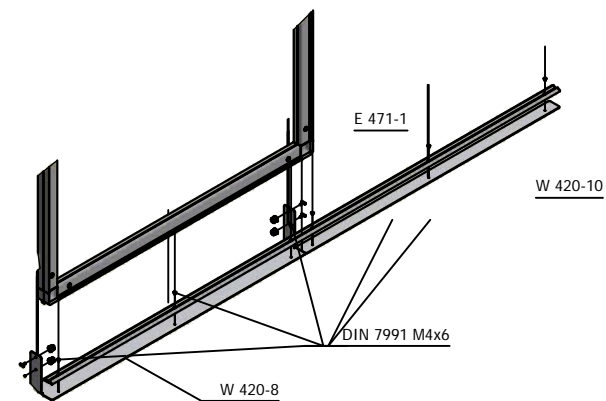

Position 2: for variants 1 and 3

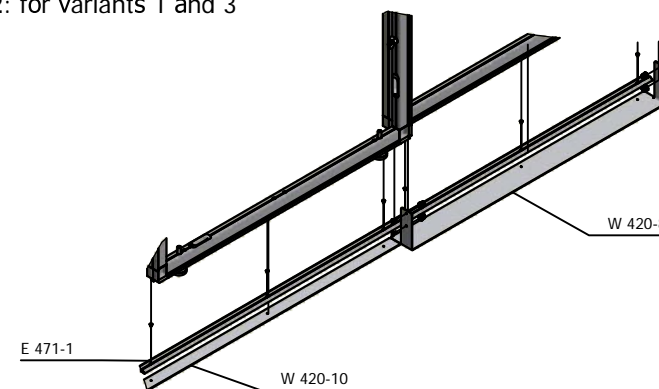

outer frame

W 938

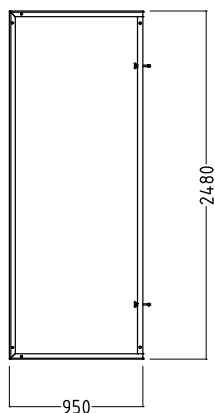

inner frame

W 937

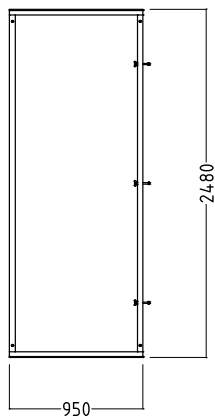

2 frame version

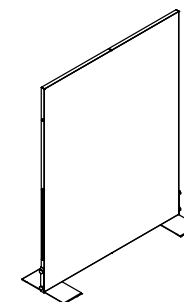
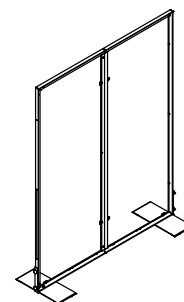
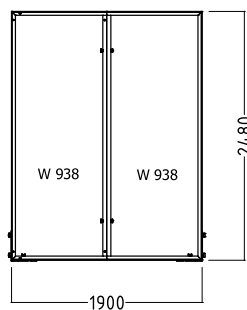

3 frame version

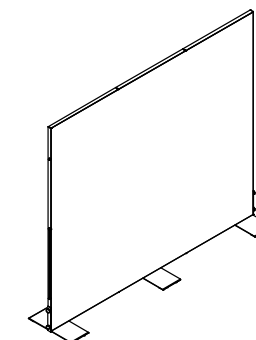
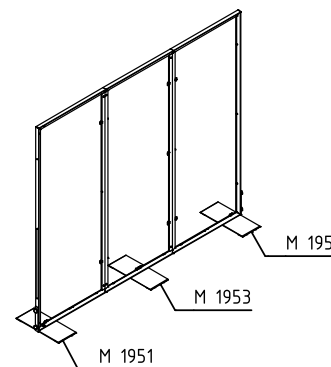
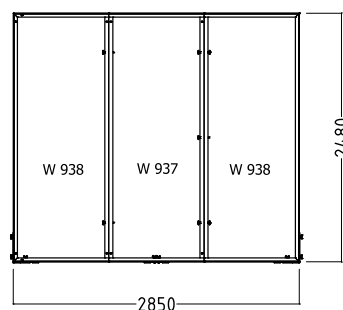

4 frame version

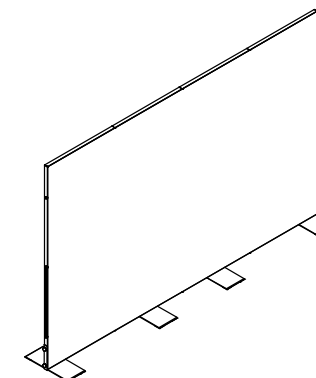
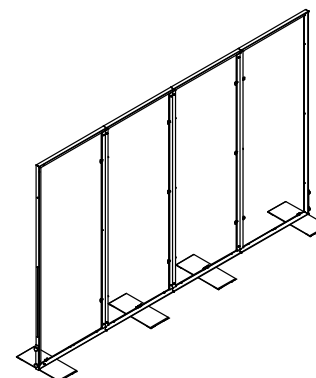
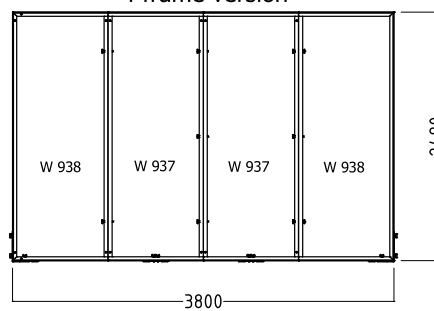

maximum construction

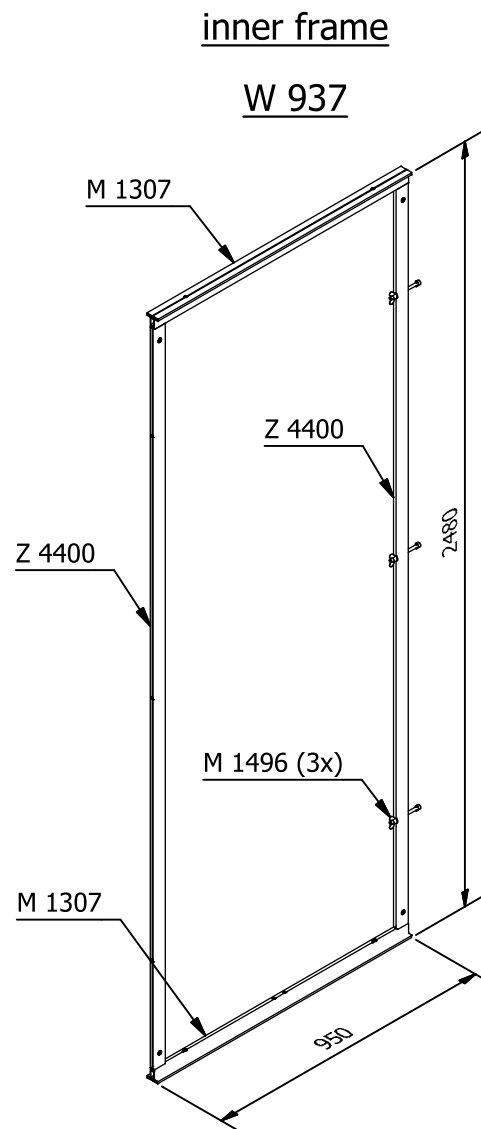
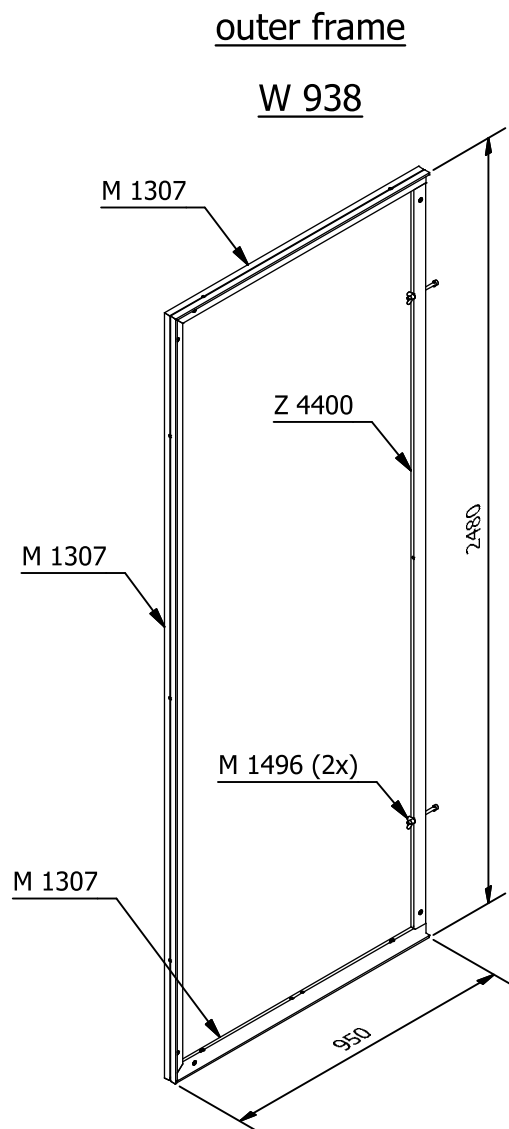

Positioning of cable outlets

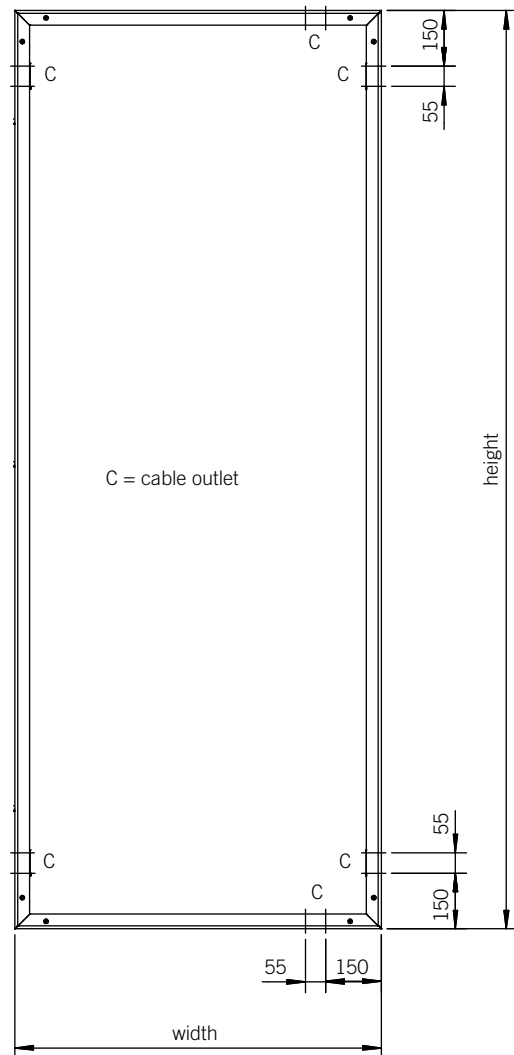

All measurements in mm!

Cable outlet and cable protection

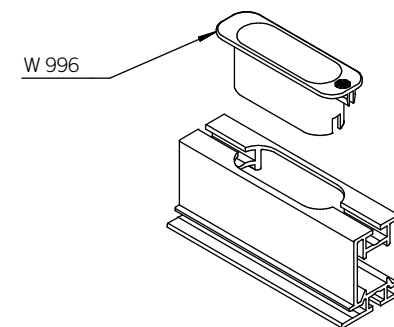
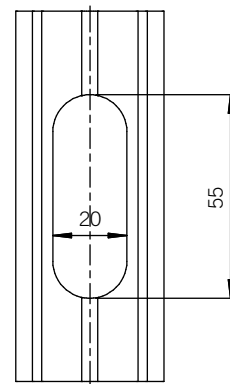

cable outlets need to be ordered separately (special version)

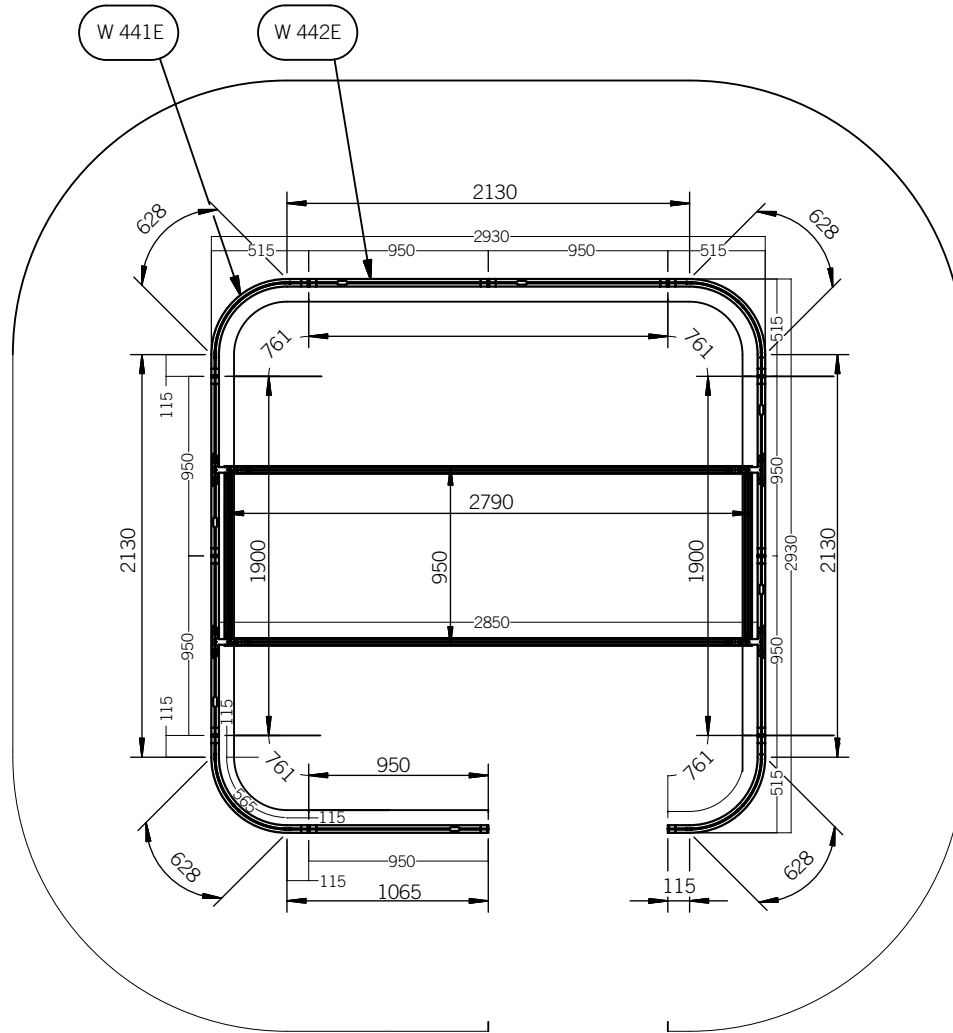

All dimensions in mm!
The drawing with dimensions remains valid!

Parts list					
Pos	Qty	Item N°	Description	L (mm)	W (mm)
1	7	W 442E	Frame element 950 x 2480 mm	2480	950
2	4	W 441E	Frame element curved, 495 mm	2480	515
3.1	4	W 466	Safety plate	250	170
3.2	1		Ceiling frame	2790	950

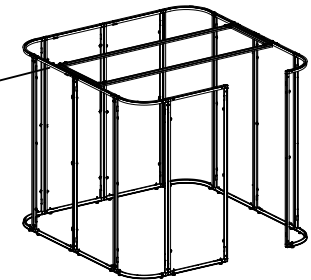
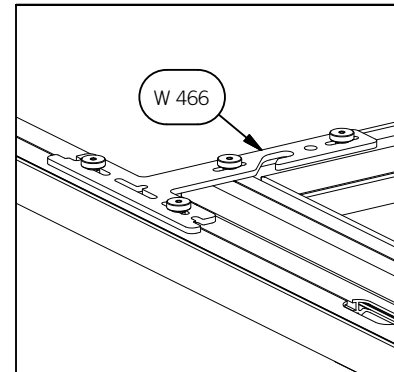

Parts list ceiling frame					
Pos	Qty	Item N°	Description	L (mm)	W (mm)
3.2.1	2	M 1305-	Frame vertical	2790	40
3.2.2	2	M 1305-	Frame horizontal , top	950	40
3.2.3	4	Z 965B	mitre	55	55

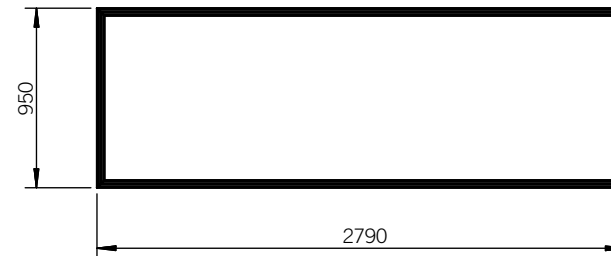

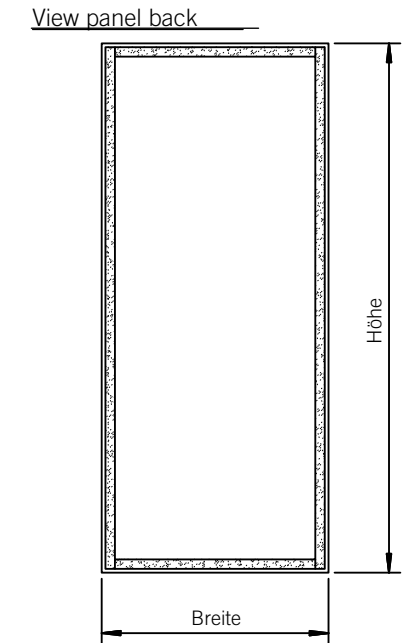
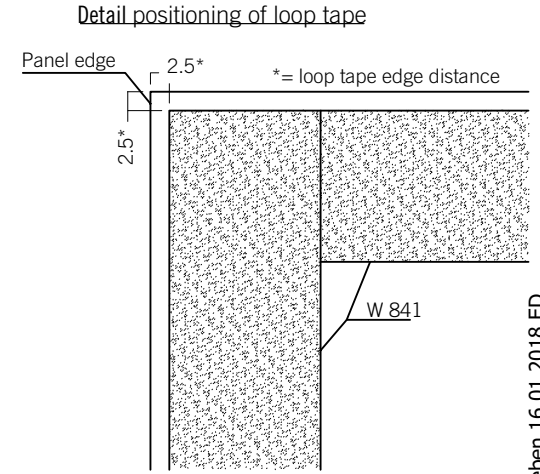
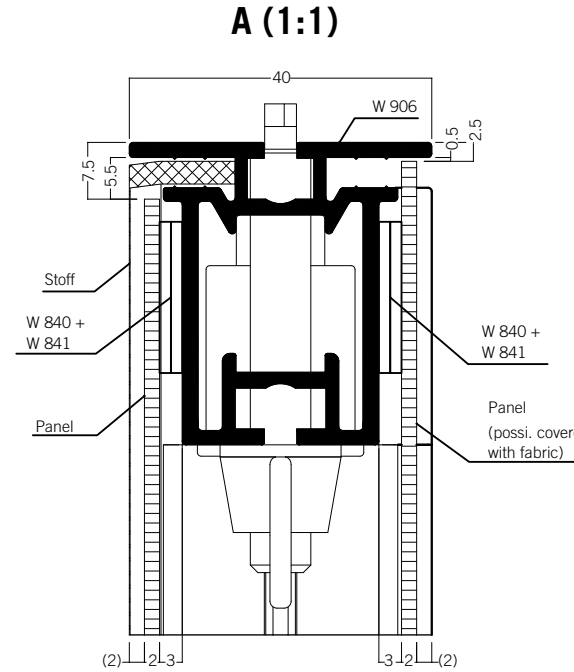
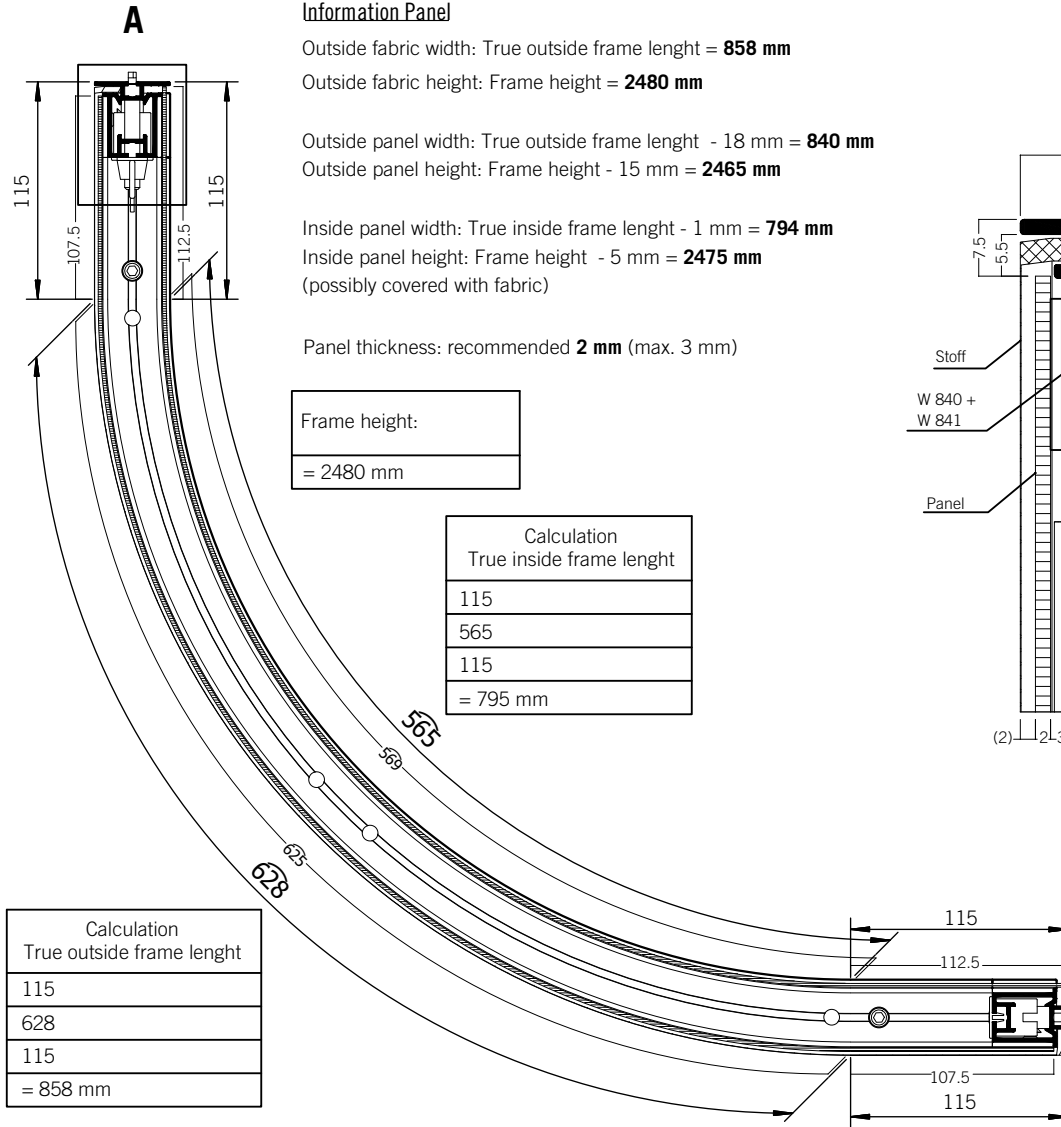

All dimensions in mm!
 The drawing with dimensions remains valid!

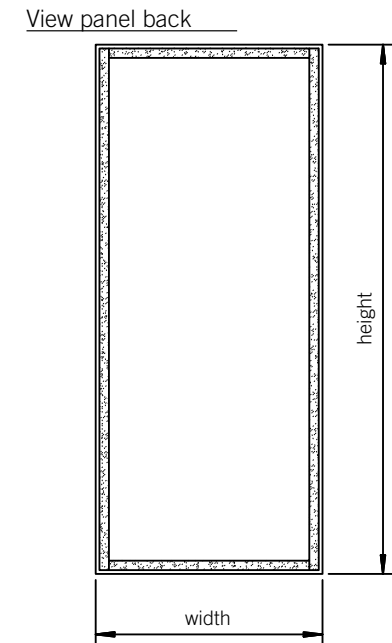
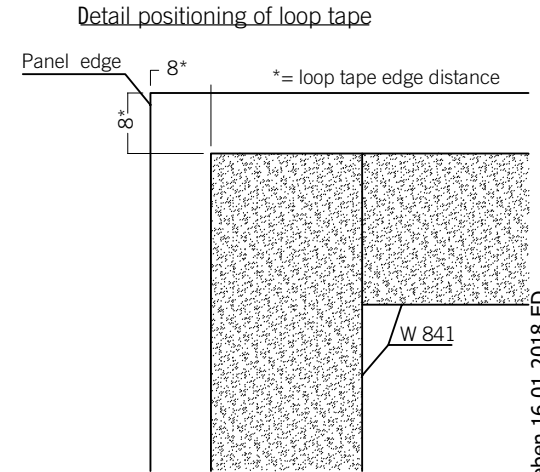
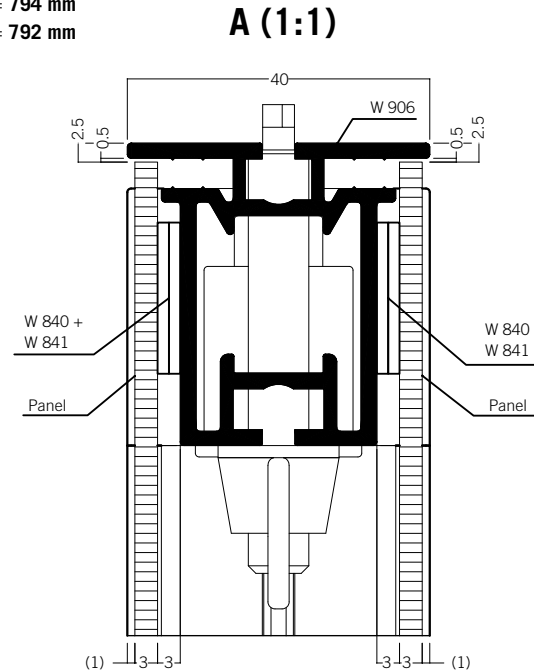
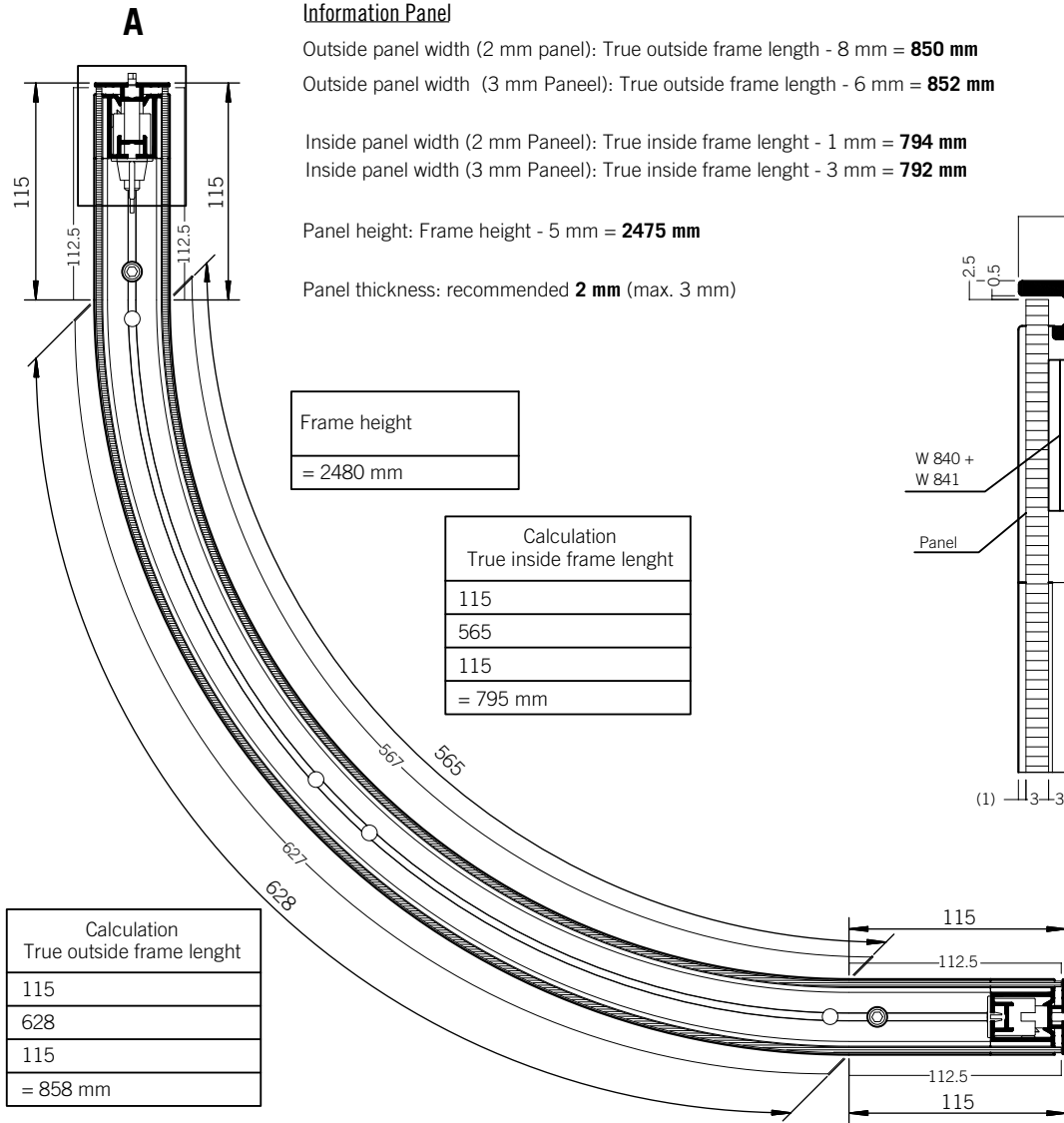

All dimensions in mm!
 The drawing with dimensions remains valid!

TI-OW-21.1 E-000577-0405A-T10 A Freigegeben 16.01.2018 ED

Loop tape requirements

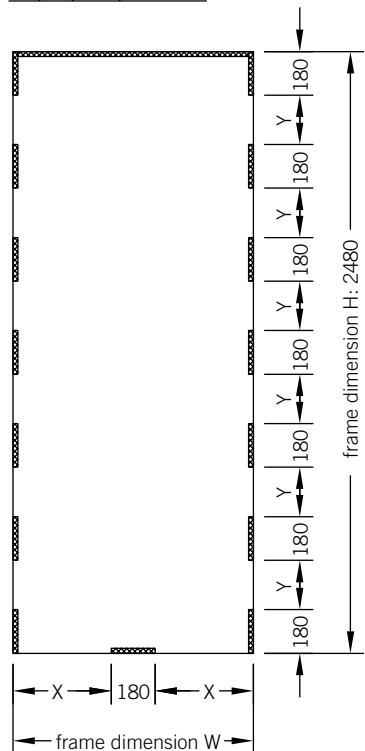

Loop tape requirements (mm)		
	H: 450	H: 2480
W: 495*	X	6400
W: 990*	3800	7400

* The stated loop tape lengths are also suitable for similar frame dimensions.

Loop tape requirements are calculated for assembly of panels on both sides of the frame.

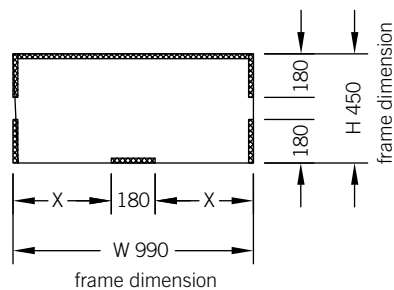

Panel dimensions

octawall 40 fabric + panel

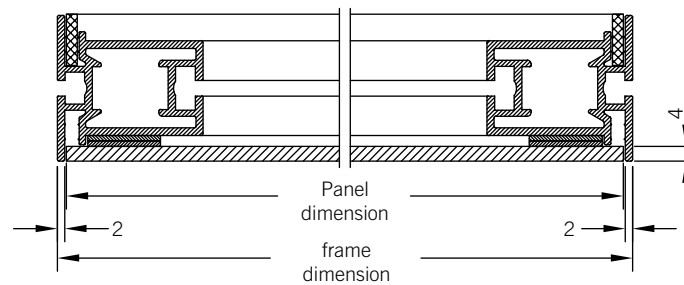

Width: frame dimension - 5 mm (calculated with 1 mm air gap)
Height: frame dimension - 6 mm (calculated with 2 mm air gap)

TI-OW-3.1 E-000408-0010A-001, gez: RE 20.06.2011 geät: RE 30.01.2018

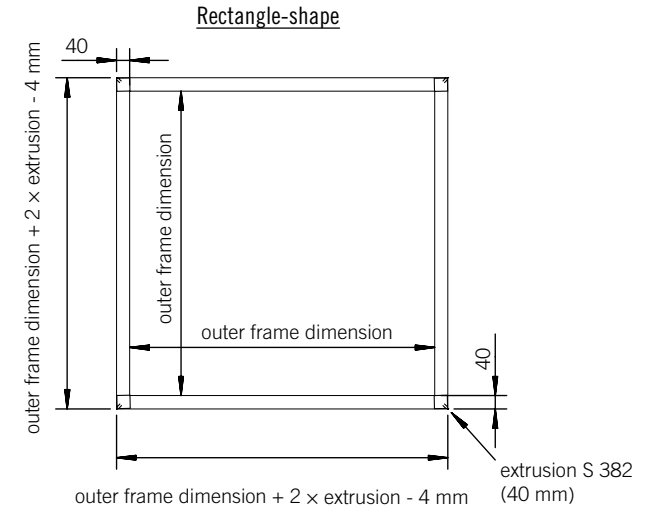
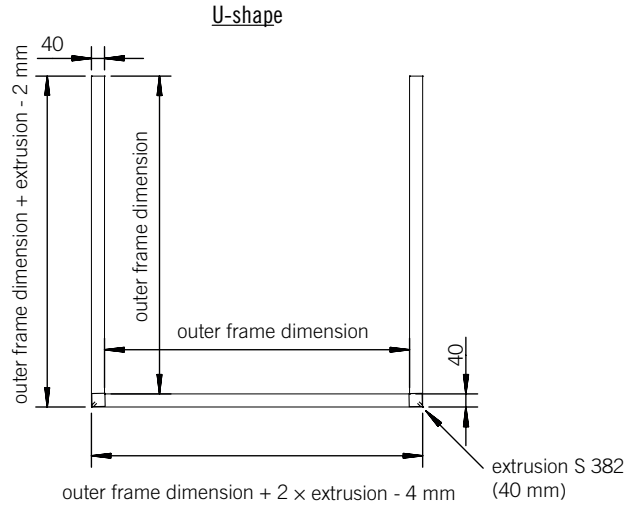
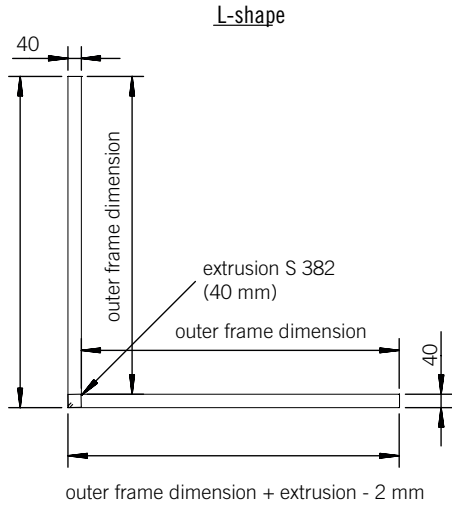

vertical fabric dimension = frame height

Cut of silicone edge

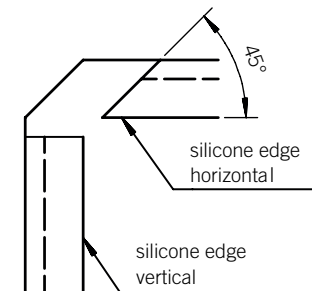

Temperature Resistance

- Temperature range from -10°C to +60°C
- The temperature at which the glue still adheres strongly depends on the surface, the humidity and the applied load

Application/Connection

- Use at room temperature 20°C (+/-5°C)
- Tape with glue and substrate must be at room temperature
- Press firmly together when gluing
- Maximum adherence after 48 hours at room temperature
- Under constant tension or pressure, the glue tends to displace slightly when used with certain fabrics
- The glue is not suitable for reuse

Surface

- Must be free of oil, dirt, dust, moisture, loose particles, monomeric plasticizers, silicones, flaking paint or coating
- Should not be too uneven, fragile, soft or unstable
- Should be suitable for the application of glue
- Should permit good bonding with adhesives, like most metals, wood, ceramics, stone, paper, cardboard, certain fabrics, various hard plastics and foams

Storage/Shelf Life

- In a dry, dark, dust-free and well ventilated room
- At a constant temperature of approx. 20°C (+/-5°C)
- Shelf life with correct storage: 12 months

User Tests/Warranty

- The above information is only for general guidance
- Based on their own tests, users should decide for themselves on the applicability of the fastening

General Instructions for Use

- Do not strain the self-adhesive tape within the first 24 hours after fastening
- Minimum recommended bonding temperature > 10°C
- Degrease the surface, e.g. with alcohol or spirit. The surface must be free of grease, moisture, dust, silicones, etc.
- Remove the protective paper and press the tape firmly in place. Pay particular attention to corners and edges!
- Bonding time: at least 1 hour at room temperature

detail Z

*extrusion for bracing,
mounted with frame connector

connection beam for
ceiling structure possible

detail Z

extrusion for
bracing

corner upright
M 1000 / M 1010

extrusion for
bracing

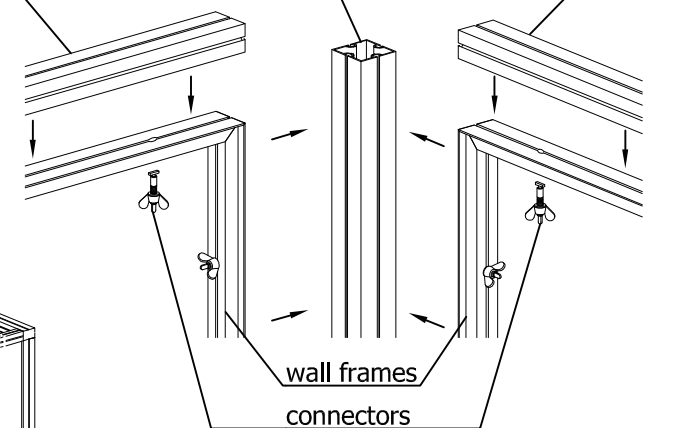

* extrusion for bracing:

octawall 40 : M 1000, Z 4700

Z 4700

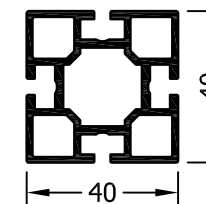
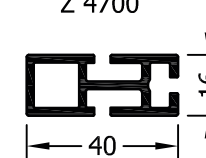

M 1000

TIMB-OW-5.0 E-000408-0020A-T01 05.07.11/RE - 11/2011 shift

Wallwasher with holding arm, supply line and external converter

The Wallwasher M 1497 is characterized by full-surface illumination across the entire height. An area of 1000 mm width and 2500 mm height is illuminated uniformly and shadow-free with a light output of 3500 lumens - without any hotspots. 5700 K provide a neutral light color and 16 high-power LEDs with lens optics ensure homogeneous illumination.

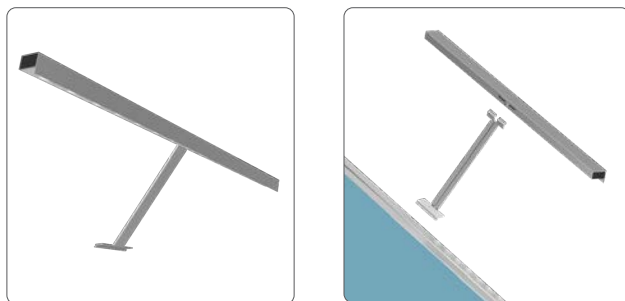

Installation is quite easy

The holding arm is swiveled into the system groove at the desired position. The wallwasher is designed in such a way that it can be integrated into any type of our **octawall** and **maxima** series from 40 - 120 mm. The only requirement is a system groove at the top of the extrusion. The supply cable is 1000 mm from converter to lamp, and 2500 mm from converter to 100-230V socket.

Space saving and secure packing

The light element and the holding arm are two separate components that are connected by simply hooking them into each other. This allows all components to be stored in one package to save space.

Cleaning and care instructions

Before cleaning, disconnect the lamp from the power supply. Do not use any corrosive or abrasive cleaning agents, but clean the lamp dry, e.g. with a microfiber cloth.

➤ Item N°:	M 1497
➤ Light Color:	5700 K
➤ Surface:	silver matt
➤ Dimmer:	dimmmable via external dimmer

2. Technical Data

➤ Manufacturer:	OCTANORM-Vertriebs-GmbH für Bauelemente Raiffeisenstraße 39 70794 Filderstadt T. +49 711 77007-30 www.octanorm.com
➤ Item:	Wallwasher
➤ Description:	Wallwasher with holding arm and external power supply unit (24V/36W) dimmmable via external dimmer (not included)
➤ Properties:	W 812 × H 263 × D 166 mm from center of groove
➤ Dimensions:	Aluminium, matt powder-coated
➤ Material Housing:	Plastic matt black
➤ Material Lateral Surface:	230V/50Hz, 5700 K/28 W
➤ Connection:	16 pcs
➤ Number of LEDs:	IP 20
➤ Housing Protection:	SKII
➤ Electrical Protection Class:	5700 K
➤ Light Color:	3600 lm/125lm/W
➤ Luminous Flux/lm per Watt:	Energy efficiency class A
➤ Efficiency:	100% direct beam, asymmetrisch wide beam
➤ Light Distribution:	RA > 90

Average rated life of the light source: L80 > 50.000 hours

1. Assembly of lamp head and holding arm

Insert the holding arm into the milled holes until you feel resistance. Then tilt the holding arm without working against any resistance, so that it engages in the millings. In this position, the lamp head can no longer detach from the holder. To detach the holder from the light head again, follow the steps in reverse order.

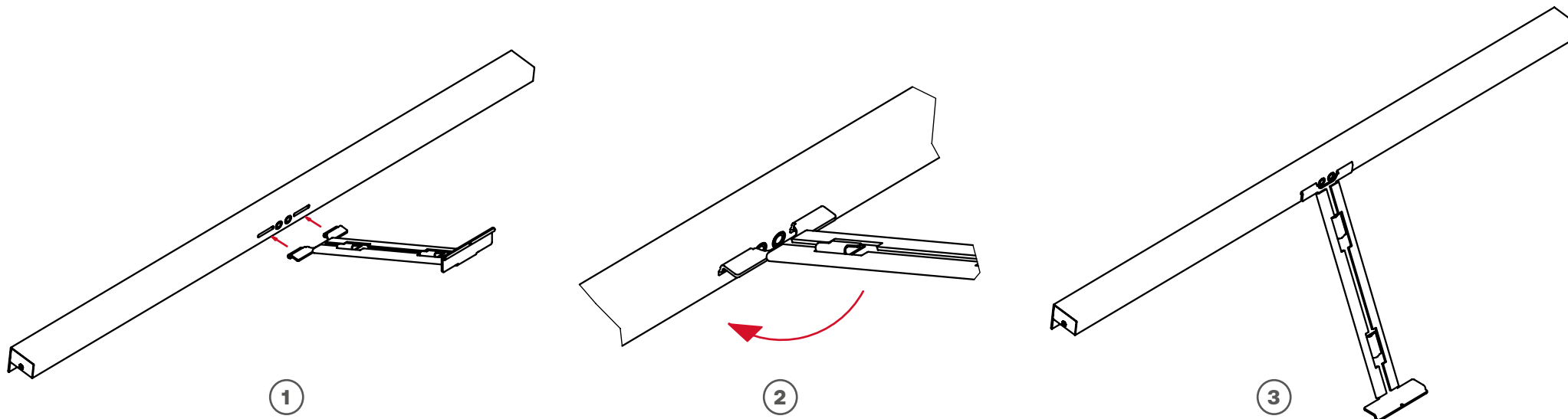

2. Installation of the lamp in the system groove

Swivel the lamp with the mounted arm into the extrusion groove. The holding arm is aligned so that it perfectly illuminates a height of 2.5 m. Be careful not to bend the arm.

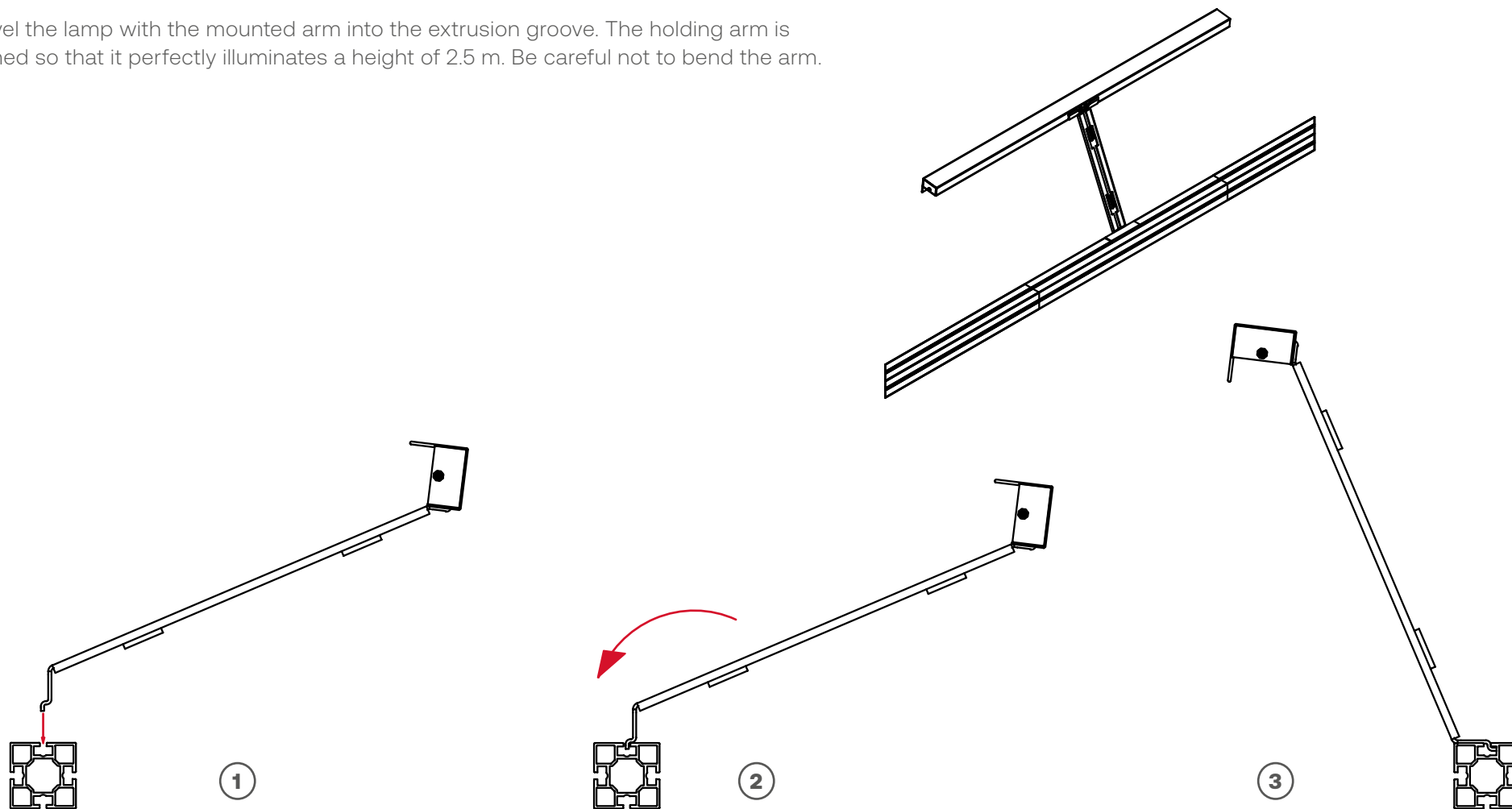

3. Wiring

A power supply unit is supplied together with the lamp for connection. The power supply cable is plugged into one of the sockets on the light head to supply the lamp with power. The remaining socket can be used with a forwarding cable if further wallwashers are to be connected in series. The remaining cable can be inserted into the retaining clips on the holding arm to take the strain off the cable all the way to the power supply.

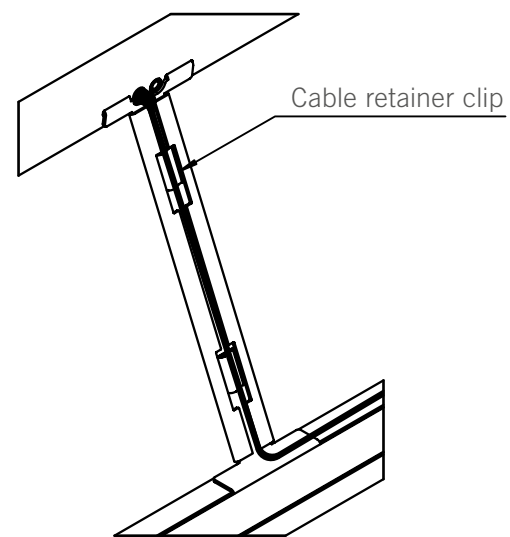
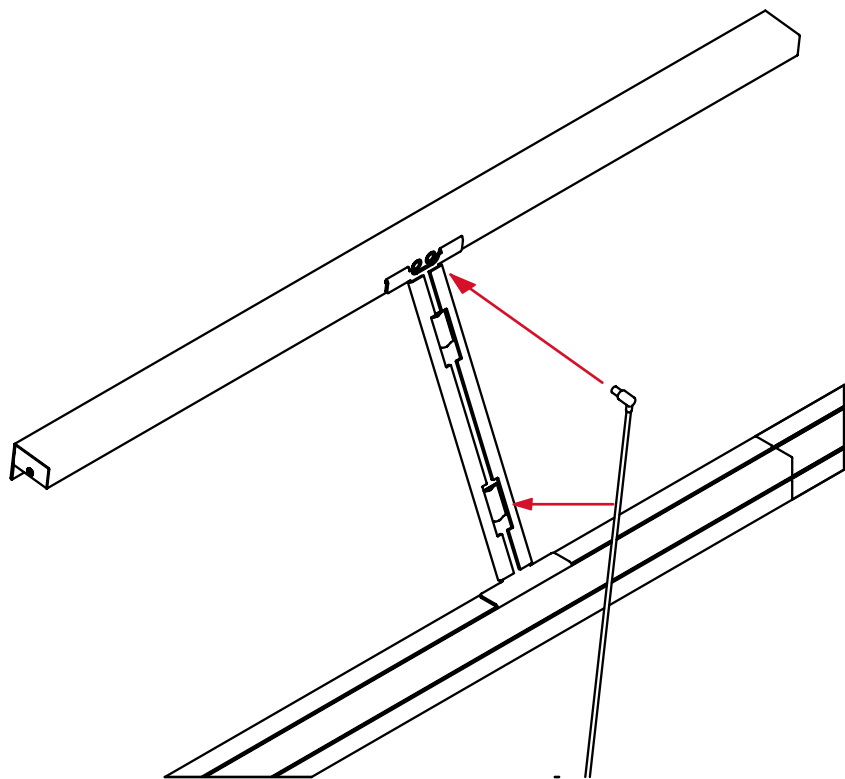

Wiring

Interconnect a maximum of 5 wallwashers per 160W power supply unit.

Connect a maximum of 3 wallwashers in series after a 160W power supply or a Y-splitter that is connected after a power supply.

Danger!

Never connect more than 5 wallwashers to one M1497-11 power supply unit and never more than 3 in series.

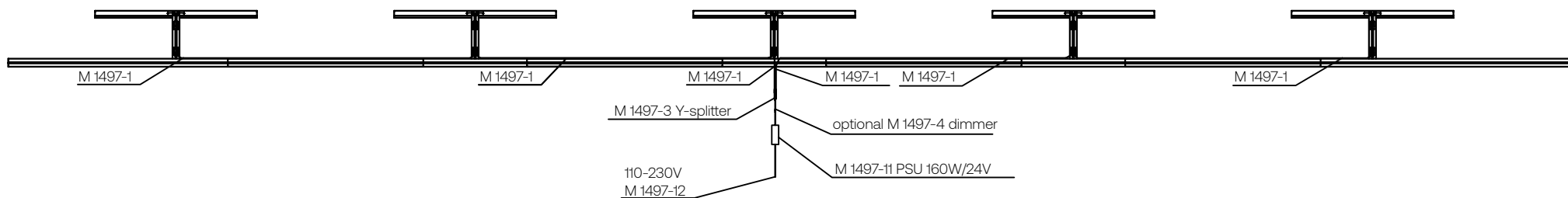

Used components:

6 × M 1497-1
connection cable

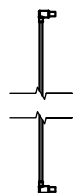

1 × M 1497-3
Y-splitter



1 × M 1497-12
power cord

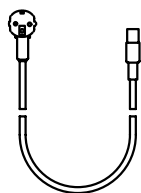

1 × M 1497-11
PSU 160W/24V



optional 1 × M 1497-4
dimmer



M 1497-H Wallwasher Hanging Lamp

TI-WW-3.0 1/4



- Item N°: M 1497-H
- Light Color: 5700 K
- Surface: black matt
- Dimmer: dimmable via external dimmer

Wwallwasher as hanging lamp, with supply live and external converter

The Wallwasher M 1497-H is characterized by full-surface illumination across the entire height. An area of 1000 mm width and 2500 mm height is illuminated uniformly and shadow-free with a light output of 7200 lumens - without any hotspots. 5700 K provide a neutral light color and 32 high-power LEDs with lens optics ensure homogeneous illumination.

- homogenous illumination of 1000 mm width and 2500 mm height
- luminous flux 7200 lm, > Cri 90
- height adjustable by Reutlinger stainless steel suspension set
- 5700 K ensure a neutral light colour
- energy-saving and durable LEDs
- with dimming option

➤ technical information

Technical Data

- Manufacturer: OCTANORM-Vertriebs-GmbH für Bauelemente
Raiffeisenstraße 39
70794 Filderstadt
Germany
T. +49 711 7700-30
www.octanorm.com
- Item: M 1497-H Wallwasher hanging lamp
- Description: Hanging lamp with power supply unit incl. DC distributor, 3 m extension cable with DC connector
- Properties: dimmable via external dimmer (not included)
- Dimensions: L 818 × W 150 × H 36 mm
- Material Housing: Aluminium, black matt powder-coated
- Material Lateral Surface: Plastic black matt
- Suspension: 3,5 m wire rope with 2 × Reutlinger stainless steel suspension set for height adjustment
- Connection: 230V/50Hz, 5700 K/56 W
- Number of LEDs: 32 pcs
- Housing Protection: IP 20
- Electrical Protection Class: SKII
- Light Color: 5700 K
- Luminous Flux/lm per Watt: 7200 lm/128lm/W
- Efficiency: Energy efficiency class A
- Light Distribution: 100% direct beam, asymmetric wide beam RA > 90

Average rated life of the light source: L80 > 50.000 hours

Cleaning and care instructions

Before cleaning, disconnect the lamp from the power supply. Do not use any corrosive or abrasive cleaning agents, but clean the lamp dry, e.g. with a microfiber cloth.

Assembly and suspension of the lamp

Insert the wire ropes from above into the two wire rope holders until the loose ends emerge again through the side opening. Provide a suitable mounting option on the ceiling for suspension of the lamp. Use the wire rope eyelets to hang the lamp directly from the ceiling or from a beam. Level the lamp by adjusting the length of the wire ropes and/or the wire rope holders.

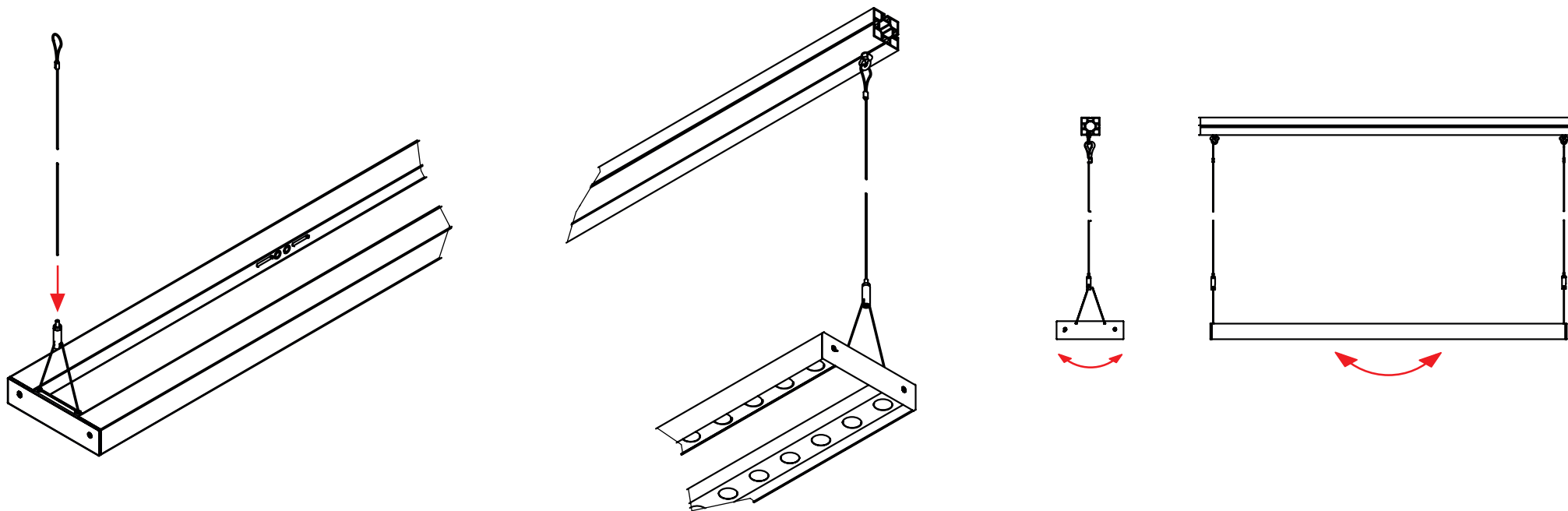

Cabling

The two plugs of the DC distribution cable are plugged into one of the two sockets on the lamp heads on each side. The other sockets on the lamp heads remain unused. The DC distributor cable is led upwards and plugged into the cable of the power supply unit.

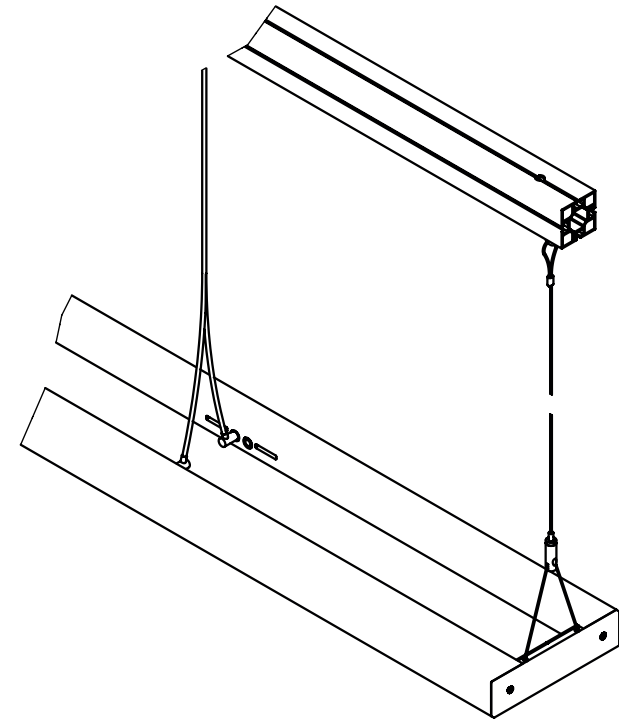
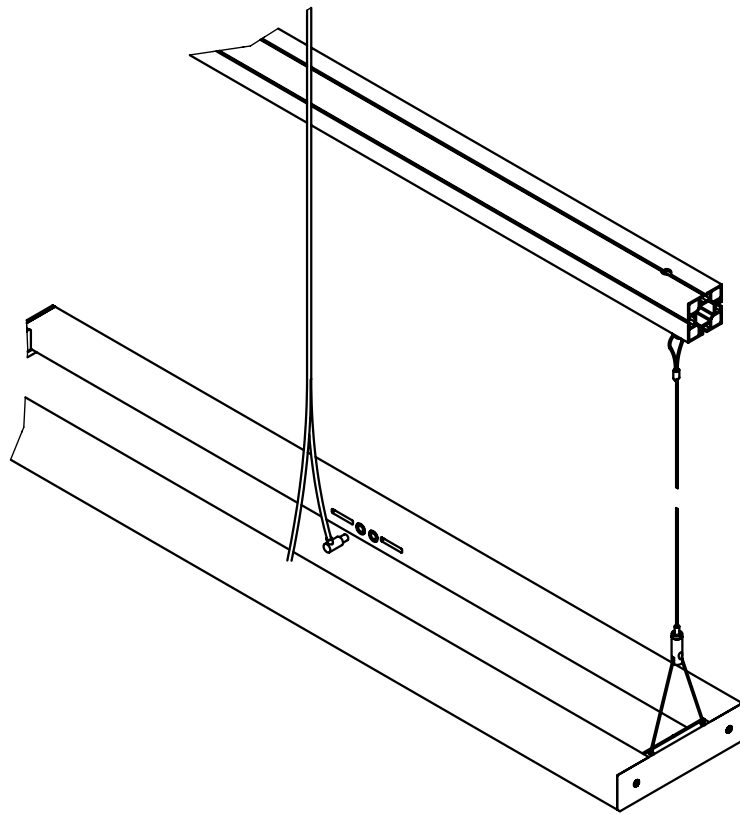

Wiring

Interconnect a maximum of 2 hanging lamps per 160W power supply unit.

Attention!

Never connect more than 2 hanging lamps to one M1497-11 power supply unit.

Always use a Y-splitter between power supply unit and hanging lamps.

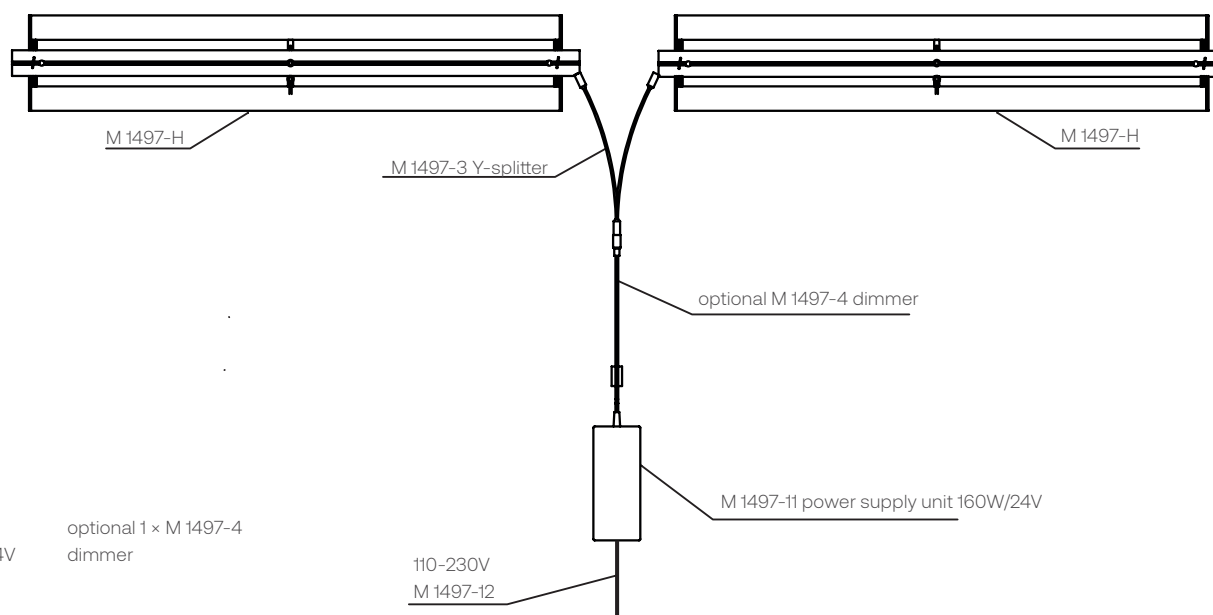

Used components:

1 x M 1497-3
Y-splitter



1 x M 1497-12
power cord

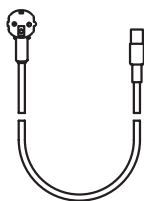

1 x M 1497-11
power supply unit 160W/24V



optional 1 x M 1497-4
dimmer



- Item N°: M 1497
- Light Color: 5700 K
- Surface: silver or black matt
- Dimmer: dimmable via external dimmer

Wallwasher with holding arm, supply line and external converter

The Wallwasher M 1497 is characterized by full-surface illumination across the entire height. An area of 1000 mm width and 2500 mm height is illuminated uniformly and shadow-free with a light output of 3500 lumens - without any hotspots. 5700 K provide a neutral light color and 16 high-power LEDs with lens optics ensure homogeneous illumination.

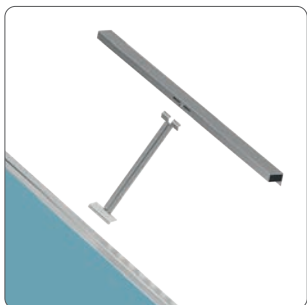

Installation is quite easy

The holding arm is swiveled into the system groove at the desired position. The wallwasher is designed in such a way that it can be integrated into any type of our octawall and maxima series from 40 - 120 mm. The only requirement is a system groove at the top of the extrusion. The supply cable is 1000 mm from converter to lamp, and 2500 mm from converter to 100-230V socket.

Space saving and secure packing

The light element and the holding arm are two separate components that are connected by simply hooking them into each other. This allows all components to be stored in one package to save space.

Technical Data

- Manufacturer: OCTANORM-Vertriebs-GmbH für Bauelemente
Raiffeisenstraße 39
70794 Filderstadt
T. +49 711 7700-30
www.octanorm.com
- Item: Wallwasher
- Description: Wallwasher with holding arm and external power supply unit (24V/36W)
- Properties: dimmable via external dimmer (not included)
- Dimensions: B 812 × H 263 × T 166 mm from center of groove
- Material Housing: Aluminium, matt powder-coated
- Material Lateral Surface: Plastic matt black
- Connection: 230V/50Hz, 5700 K/28 W
- Number of LEDs: 16 pcs
- Housing Protection: IP 20
- Electrical Protection Class: SKII
- Light Color: 5700 K
- Luminous Flux/lm per Watt: 3600 lm/125lm/W
- Efficiency: Energy efficiency class A
- Light Distribution: 100% direct beam, asymmetrisch wide beam
RA > 90

Average rated life of the light source: L80 > 50.000 hours

Cleaning and care instructions

Before cleaning, disconnect the lamp from the power supply. Do not use any corrosive or abrasive cleaning agents, but clean the lamp dry, e.g. with a micro-fiber cloth.

Assembly of lamp head and holding arm

Insert the holding arm into the milled holes until you feel resistance. Then tilt the holding arm without working against any resistance, so that it engages in the millings. In this position, the lamp head can no longer detach from the holder. To detach the holder from the light head again, follow the steps in reverse order.

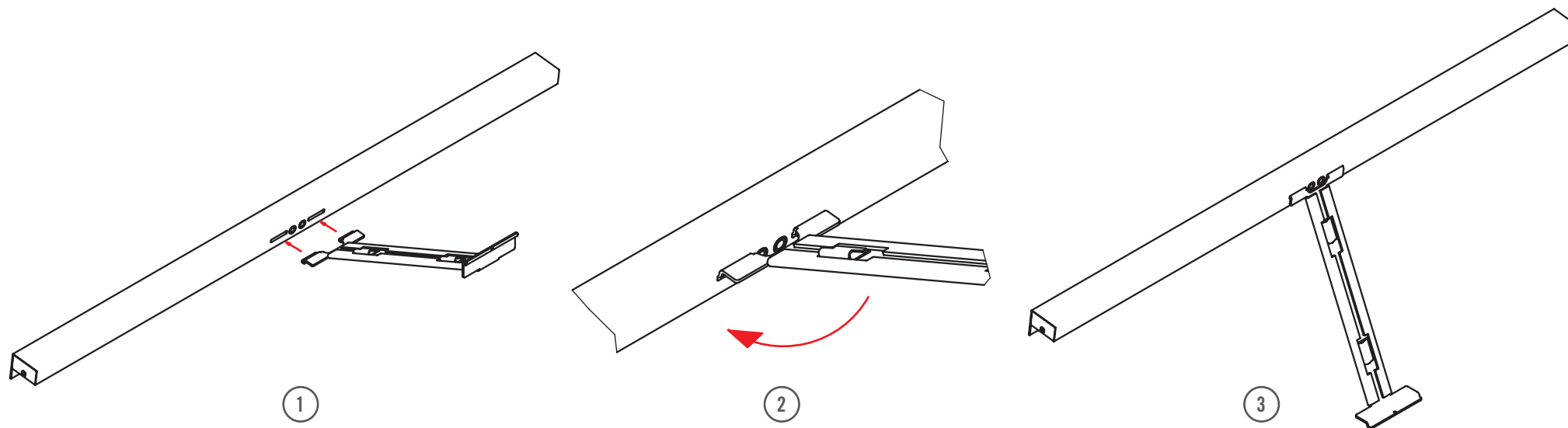

Installation of the lamp in the system groove

Swivel the lamp with the mounted arm into the extrusion groove. The holding arm is aligned so that it perfectly illuminates a height of 2.5 m. Be careful not to bend the arm.

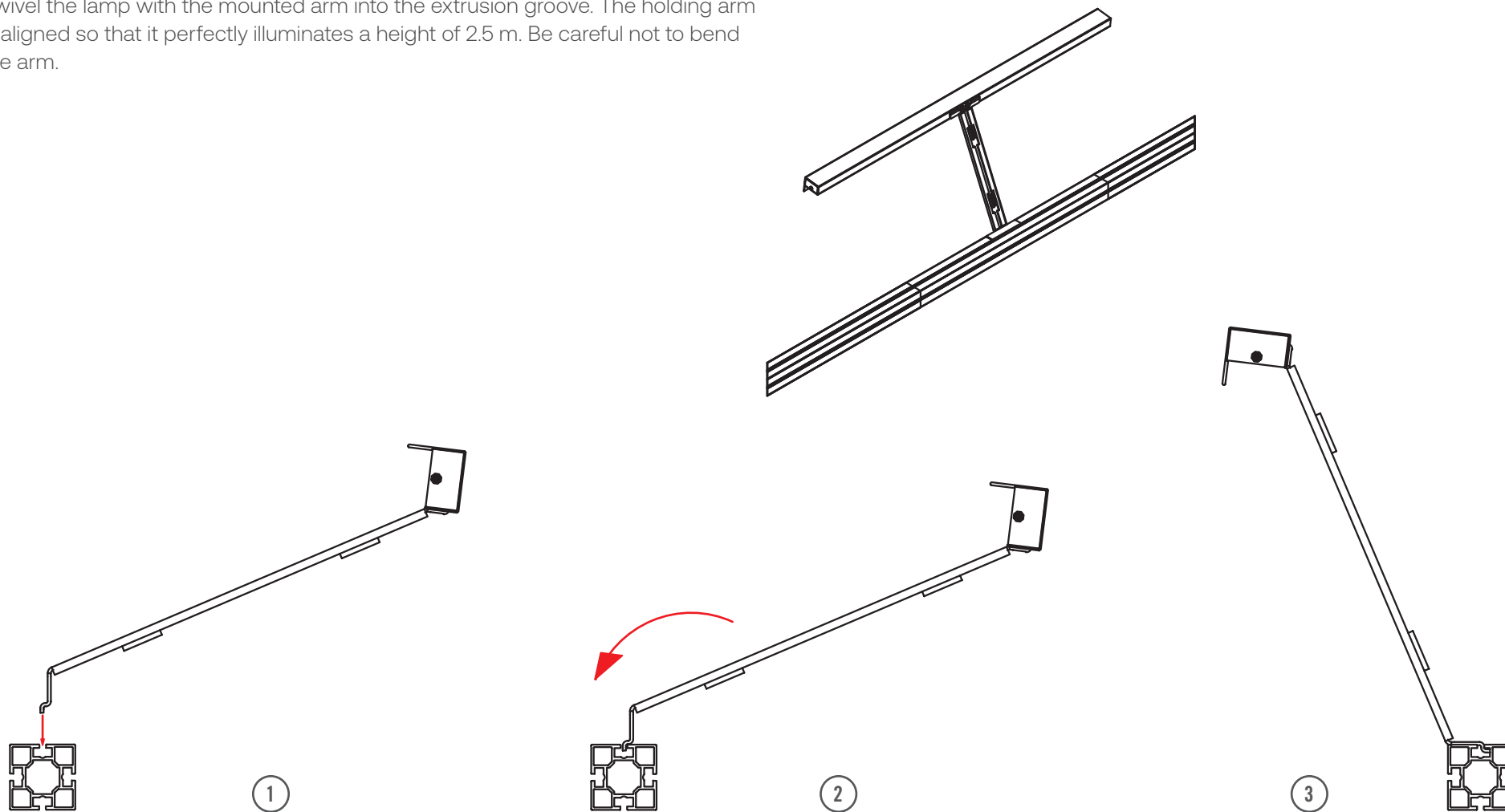

Wiring

A power supply unit is supplied together with the lamp for connection. The power supply cable is plugged into one of the sockets on the light head to supply the lamp with power. The remaining socket can be used with a forwarding cable if further wallwashers are to be connected in series. The remaining cable can be inserted into the retaining clips on the holding arm to take the strain off the cable all the way to the power supply.

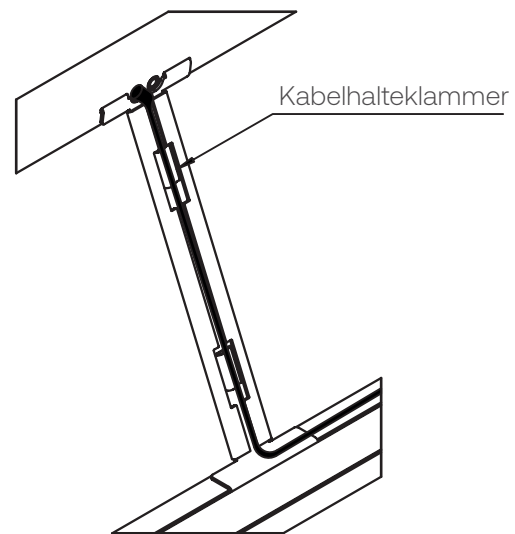
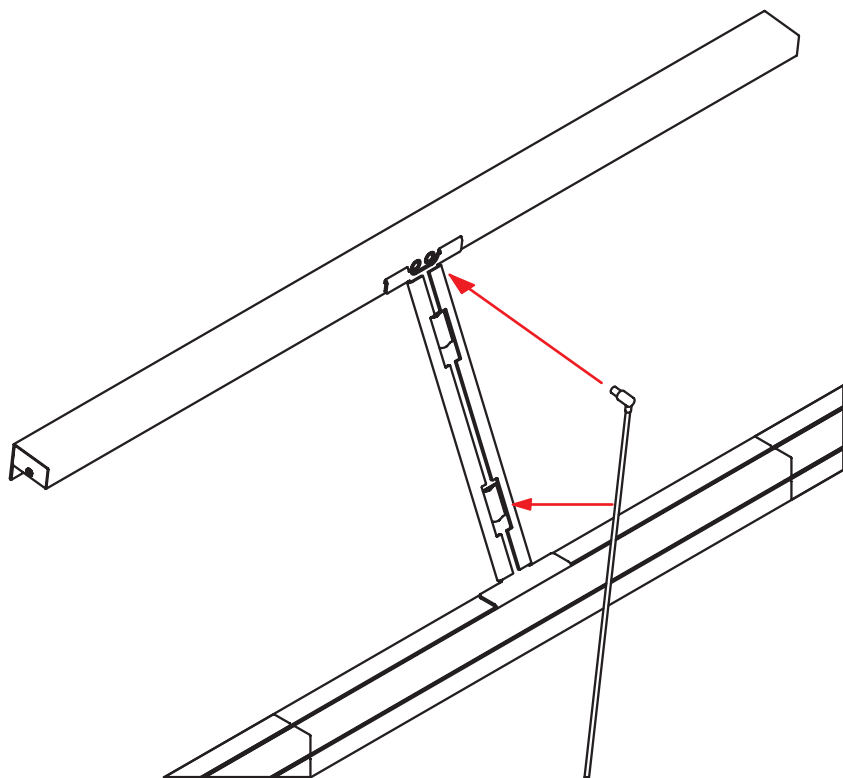

Wiring

Interconnect a maximum of 5 wallwashers per 160W power supply unit.
 Connect a maximum of 3 wallwashers in series after a 160W power supply or a Y-splitter that is connected after a power supply.

Attention!

Never connect more than 5 wallwashers to one M1497-11 power supply unit and never more than 3 in series.

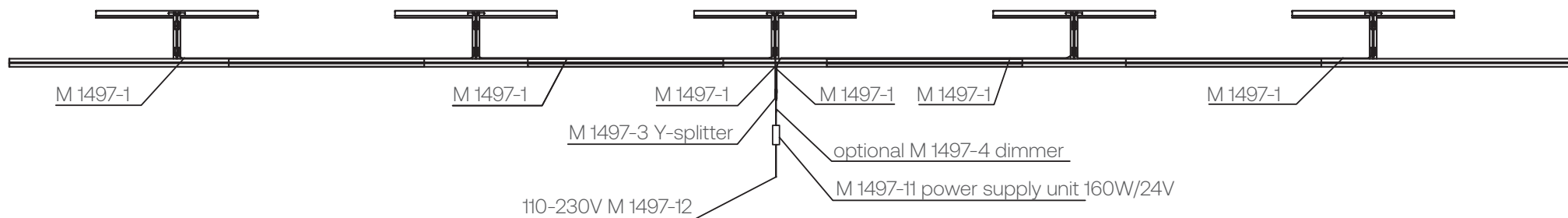

Used components:

6 × M 1497-1
connection cable

1 × M 1497-3
Y-splitter

1 × M 1497-12
power cord

1 × M 1497-11
power supply unit 160W/24V

optional 1 × M 1497-4
dimmer

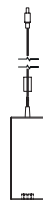
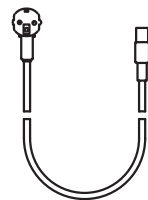



Mini wireless-sync-control led dimmer with touch remote

Controller adopts the most advanced PWM (Pulse Width Modulation) digital control technology, it is used for controlling constant voltage LED lamps. For instance, point source of light, flexible light strip, led modules, led strings and so on.

1. Product Features

- Designed for M 1497 wallwasher
- DC12-24V, output current: 1ch*6A(DIM)
- Adopts RF remote control, no need line-of-sight
- Wireless-sync-control in both static color and dynamic modes, unlimited by remote control distance
- Batch-operation is available for RF code matching/clearing between remote control and receivers
- Memory function, each time power-on reserve the mode which stop in the last power-off
- Perfect control effect, soft dim function
- Long-press the brightness and speed key can get the fast adjustment, convenient for operation
- Also adopts Button function for switch on/off and change color
- Warranty of this product is one year, exclude the artificial situation of damaged or overload working

2. Technical Parameters

Touch Remote Control

- Working temperature: -20 - 60°C
- Standby current: 8uA
- Standby power: 36uW
- Net weight: 65g
- RF distance: ≤20m
- Supply voltage: 4.5V (AAA 3pcs)
- Working current: 30mA
- Working power: 135mW
- External dimension: L 150 × W 40 × H 20 mm
- RF frequency: 433.92MHz

Controller

- Working temperature: -20 - 60°C
- Static power consumption: <1W
- Grayscale: infinitely variable
- External dimension: L 48 × W 26 × H 13 mm
- Net weight: 20g
- RF frequency: 2.4GHz
- Output color order settable: Yes, RGB/RGBW
- Output: DIM 1 CH
- PWM frequency: 1.95KHz
- Supply voltage: DC 12V-24V
- Speed stage: infinitely variable
- Packing size: L 100 × W 65 × H 40 mm
- Gross weight: 40g
- RF distance: ≤20m
- Memory function: Yes
- Output current: ≤6Am (total) DIM:1 × 6A
- Max. Output power: 12V: <72W, 24V: <144W

3. Dimension

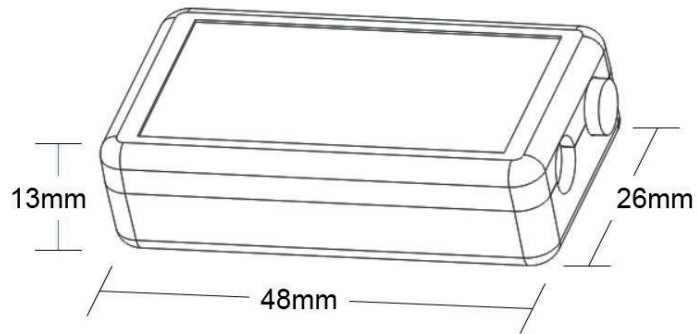

4. Interface Specifications

Input port: DC plug (2.1/5.5)



Output port: DC plug for DIM



Button



5. Direction for Use

Wireless-synchronization function

Receivers will transmit the control signals from the remote control and self-inspection the work statuses for each other, so multiple receivers in same zone will wireless-sync-work completely, not only static mode but also dynamic mode, to achieve wired-like operation experience.

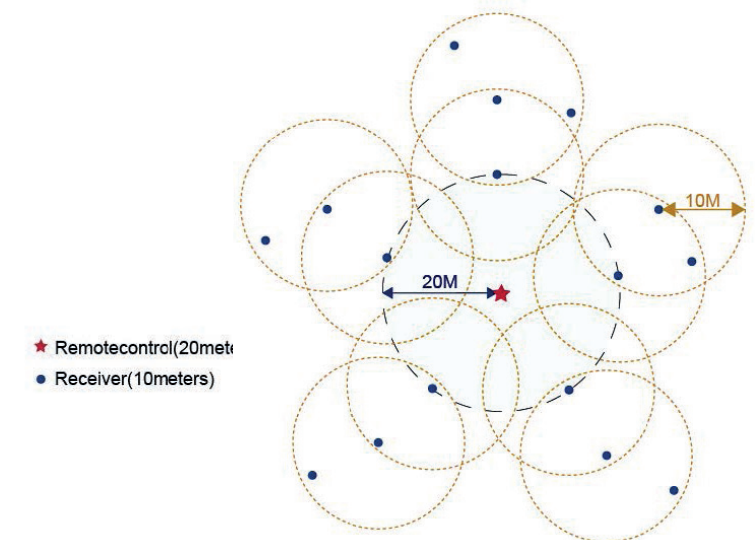

Button Control Function

- Short pressing to switch on/off the light in any time.
- Long-pressing during the controller in working state, the output light brightness, just release press when you get the correct brightness.

6. Touch Remote

Adopts RF full touch control, with one dimming ring and 5 function buttons.

Tips: Without any operation more than 20 seconds, the touch remote will enter the sleep state, please **shake** the remote to wake up it before the next using.



Name of key	Instruction	Remarks
Off	Off in any time	
On	On in any time	
Mode	The mode will go to next, when you touch the key each time	2 modes in total: fade or flash (speed is adjustable, brightness is unadjustable)
Speed/Brightness +	The speed/brightness will +1, when you touch the key each time	Speed for dynamic modes, brightness for static modes
Speed/Brightness -	The speed/brightness will -1, when you touch the key each time	Speed for dynamic modes, brightness for static modes
Dimming Ring	For brightness selection	

7. Typical Applications

Application Circuit 1: Single color (DC plug 2.1/5.5)

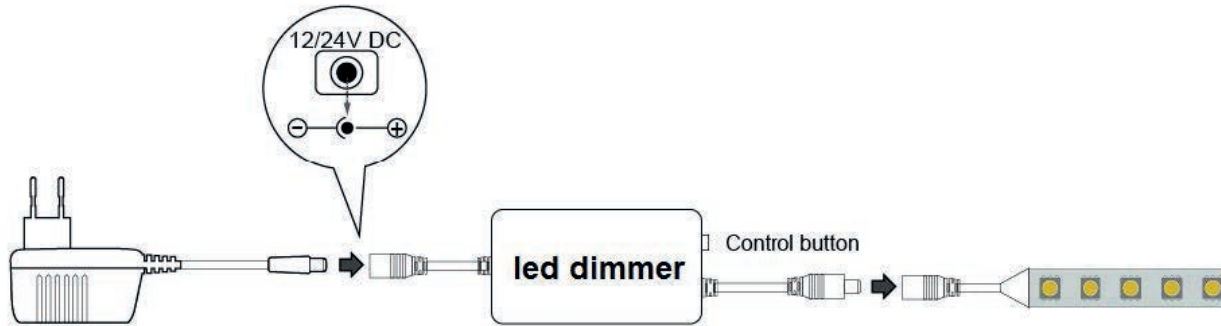

8. About RF Code

The biggest advantage of this system is that it can not only solve the cabling problem in engineering wirelessly, but also realize a wired-like operation experience. In order to facilitate the early testing and debugging of the project, the factory status of the receiver is normally unpaired and each remote controller has a unique code value. The user should perform the matching work of the remote controller and the receiver during the installation of the project to avoid the mutual influence of the radio frequency remote control technology during the later use.

Please pay attention to the following 3 points before operation:

- All equipment in the complete system after installation should have a unified and unique code value, so as to achieve the security and stability of the system.
- The receiver can only store one code value and cannot be overwritten. Before learning the new code value, it is necessary to clear the original code of the receiver; the remote controller can only save one code value but can be overwritten and can also restore the factory settings. In order to facilitate the later maintenance, the three components that may be involved in the system (including receivers, handheld remote controllers, and panel remote controllers) can realize mutual learning of code values.
- Since the receiver performs code value learning in the power-on state, batch-operation is available **(power-one the all receivers which will be in same zone, and operate the matching/clearing the RF code all of them at the same time)**. And in order to avoid confusion in the area, it is recommended that each area has an independent power switch so that the power of other areas can be easily cut off when the code is being operated.

1. Code pairing operation (means that the receiver will only be controlled by the value code remote controller)

2. Code clearing operation (means that the original code value of the receiver will be cleared and returned to the factory state. Then it can be controlled by any compatible remote control, and can learn to a new code)

Step	Operation	Instructions
1	Connecting the load to the receiver and power on it.	1.It is necessary to clear the code first, if the receiver was coded before. 2.Batch operation can be performed within the remote control range.
2	Press and hold "ON" on the remote control for 5 seconds, the indicator of the remote control will flash quickly, means it enters the pairing code transmission status.	Will automatically exit code transmission status after 60 seconds, or pressing any key to exit.
3	See the load light flashes 3 times and return to the initial state.	2 modes in total: fade or flash (speed is adjustable, brightness is unadjustable)

Step	Operation	Instructions
1	Connecting the load to the receiver and power on it.	1. The clearing operation should be finished within 1 minute after the receiver is powered on. If exceeds the time, can be powered on again. 2. Batch operation can be performed within the remote control range.
2	Press and hold the remote control "Off" for 5 seconds. The indicator of the remote control flashes quickly, means it enters the clearing code transmission status.	1. Will automatically exit code transmission status after 60 seconds, or pressing any key to exit. 2. If the original remote control is lost, the new remote control can be used for clearing operations.
3	See the load light flashes 3 times and return to the initial state.	Clearing coding is finished successfully.

3. Code learning operation between remote controls (used to unify system code values or copy a new remote controls)

Since each remote control has its own unique code at the time of delivery, when there are multiple remote controls in one system, one of them (for example, remote control A) must be selected as the system code value, and the code value of the rest remote controls (for example, remote control B) should be copied to the same one.

Step	Operation	Instructions
1	A remote control: Press and hold "ON" on the remote control for 5 seconds, the indicator of the remote control will flash quickly, means it enters the pairing code transmission status.	Will automatically exit code transmission status after 60 seconds, or pressing any key to exit.
2	B remote control: long press „mode key“ for 5 seconds, the remote indicator light changes from 100% light to off light, means entering the code value receiving state.	Will automatically exit the code value receiving state after 30 seconds, or exit after learning the code value successfully.
3	See the B remote control indicator light flash 3 times.	Code copying is finished and exit code value receiving status.

4. The remote controller restores the factory setting (it means that the remote control will be restored to the factory's unique code value)

Step	Operation	Instructions
1	Long press „mode“ for 20 seconds.	The remote indicator light dim down and flashes continuously until the 20th second and then back to 100% light. Means this step is finished.
2	Press „Off“ to confirm, the remote indicator light flashes 3 times	Restore factory settings successfully.

Attention!

1. In order to extend the life of the battery, the remote control will enter sleep mode without any operation for 10 seconds, please pressing any key to wake up it before using.
2. The signal of the touch ring/buttons is continuously transmitted for a maximum of 30 seconds, please release it and operate again if times out.

octawall 40

toolless

» Technics 05/26

Toolless frame system for fabric and panel

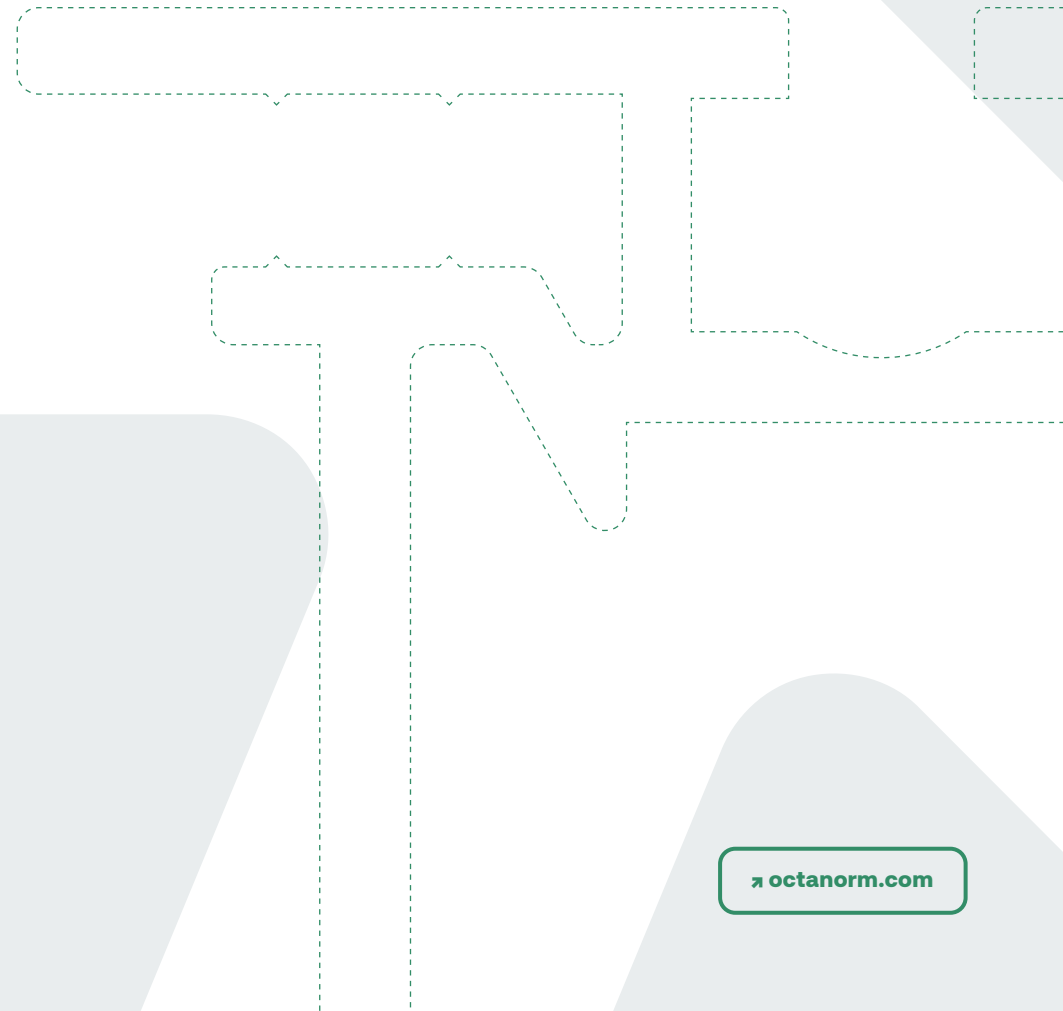
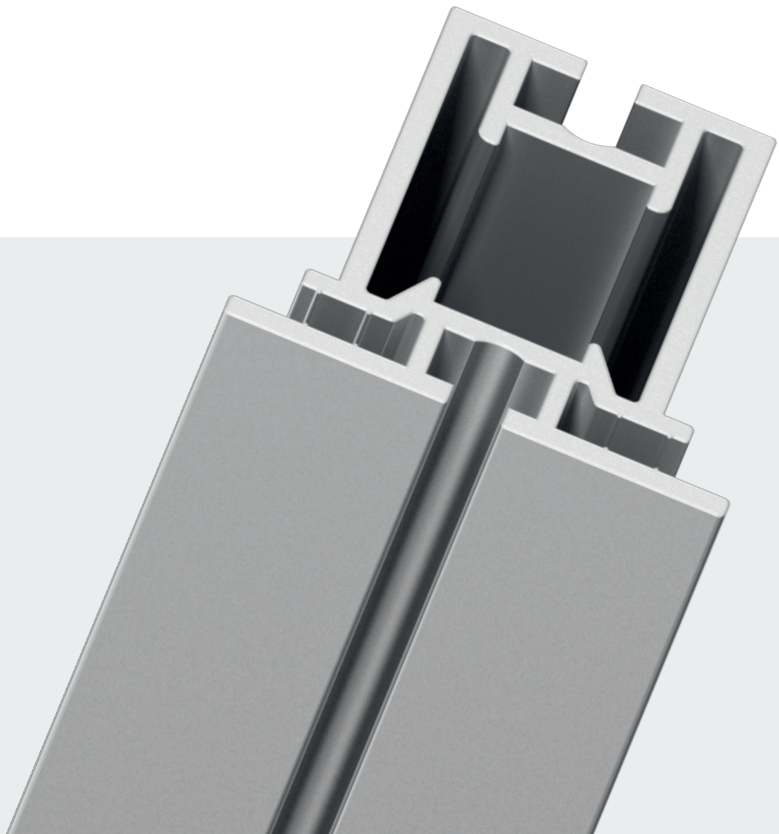

➤ Contents

➤ octawall 40 toolless	
➤ Frames	93
➤ Basic parts	94
➤ Accessories	97
➤ Doors	98
➤ Fabric/Panel/Glass	100
➤ Packaging/Transport	101
➤ technical information	102

Frames

octawall 40 toolless

Frame

toolless
W 950 × H 2480 × D 40 mm



W 402M.01 aluminium

1 × frame of W 906, for double-sided fabric, with plugable connection, center-split, incl. 2 × rotatable foot plates M 1956 and 1 × bracing, incl. 1 × shoulder bag W 494, 4 × corner connector W 916M, 2 × connector OL 240M, 3 × mounting-set M 1496, Drillings for cable management available on request

W 950 × H 2480 × D 40 mm | 8.93 kg

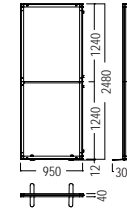

Attention: freestanding only for double-sided fabric!

fabric dimension = outer frame dimension

Frame

toolless
40 mm, custom size



W 403M.01 aluminium

1 × frame of W 906, for double-sided fabric, with plugable connection, center-split, incl. 2 × rotatable foot plates M 1956 and 1 × bracing, incl. 1 × shoulder bag W 494, 4 × corner connector W 916M, 2 × connector OL 240M, 3 × mounting-set M 1496, Drillings for cable management available on request, fabric dimension = outer frame dimension

40 mm, custom size |

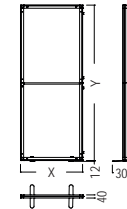

Attention: freestanding only for double-sided fabric!

X = 495-1200 mm, Y = 1000-2500 mm

Frame

toolless
40 mm, custom size



W 413M.01 aluminium

1 × frame of W 906, for double-sided fabric/panel, with plugable connection, center-split, incl. 2 × adjustable foot C 440/F6 and 1 × bracing, incl. 1 × shoulder bag W 494, 4 × corner connector W 916M, 2 × connector OL 240M, 3 × mounting-set M 1496, optional with hook tape W 840, Drillings for cable management available on request

40 mm, custom size |

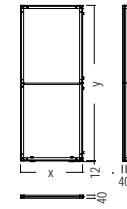

Attention: freestanding only for double-sided fabric!

fabric dimension = outer frame dimension

Basic parts

octawall 40 toolless

Tension fabric extr.

for double sided fabric / panel
L 6000 × W 40 × H 40 mm

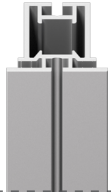

W 906.01

aluminium

for double-sided fabric (in combination with silicone edge M 1313)
or panels

L 6000 × W 40 × H 40 mm | 6.345 kg

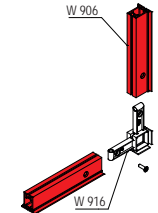
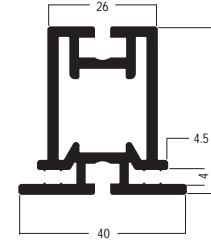

Corner upright extrusion

90° corner
with silicone edge groove



S 382.01

aluminium

90°, for connection of octawall 40 frames, fabric can be mounted
over the extrusion right to the edge

L 5000 × W 40 × H 40 mm | 6.912 kg

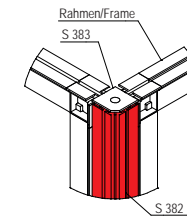
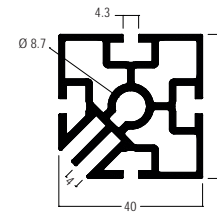

Corner upright

silicone edge groove
90°, toolless



S 381M.01

aluminium

1 × upright of 40 mm corner upright extrusion S 382, toolless,
separated with longitudinal connector S381M3, fabric can be
mounted over the profile onto the edge, incl. 2 × end cap S 383
and 1 × adjustable foot W 913/1

L 40 × W 40 × H 2480 mm | 3.58 kg

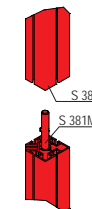

Basic parts

octawall 40 toolless

Fixing set

for frame connection
L 100 × W 39 × H 39 mm

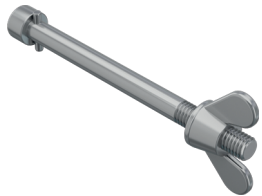

M 1496.37

steel

for connection of frame elements
L 100 × W 39 × H 39 mm | 0.066 kg

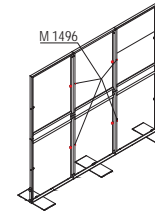
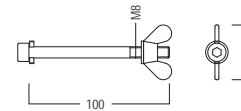

drilling of frames at same level

Fixing set

for frame connection
L 74 × W 39 × H 39 mm



M 1477.37

steel

for connection of frames W 940 - W 949 / M 1304 / M 1305 and M 1307
L 74 × W 39 × H 39 mm | 0.035 kg

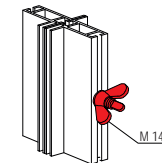
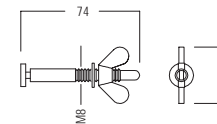

drilling of frames offset

Knuckle

90°, toolless
L 106 × W 106 × H 40 mm

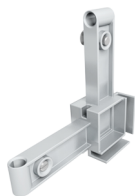

W 916M.39

zinc die cast

for pluggable and dismountable connections, bolted on one side
L 106 × W 106 × H 40 mm | 0.214 kg

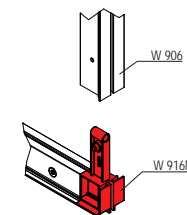
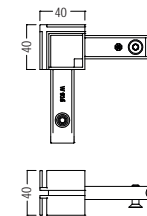

Basic parts

octawall 40 toolless

Internal connector

straight, toolless
L 180 x W 20.6 x H 11.6 mm



OL 240M.00

aluminium

for pluggable and dismountable connections, bolted on one side,
incl. 1 x countersunk-head screw E 111/m, 1 x countersunk-head
screw M 1510/20

L 180 x W 20.6 x H 11.6 mm | 0.124 kg

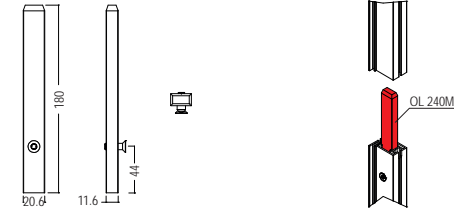

Accessories

octawall 40 toolless

Adjustable foot

M10
for frame elements



C 440/F.37

steel

for installation in frame elements in connection with Z 990 internal corner connector or W 916/S corner connector

L 40 × W 40 × H 80.5 mm | 0.073 kg

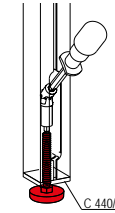
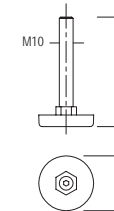

Base plate

toolless
rotatable



M 1956.21

steel

rotatable, for freestanding frame elements toolless, incl. fixing accessories

L 301 × W 50 × H 12 mm | 0.496 kg

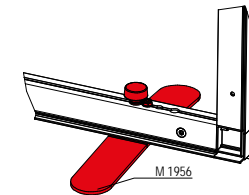
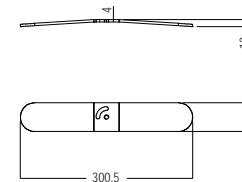

End cap

for extrusion S 382
L 40 × W 40 × H 6 mm



S 383.35

plastic

for extrusion S 382, to build the upper and lower piping groove on the edge

L 40 × W 40 × H 6 mm | 0.004 kg

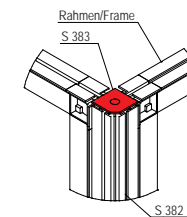
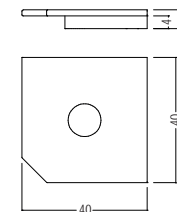

Doors

octawall 40 toolless

Window element

for door W 425 / W 575
W 775 × H 1941 × D 40 mm



W 414.01

aluminium

1 × window element made of W 906 for double sided fabric/panel, in addition to door element W 425 and W 575, Window size: W 200 × H 800 mm

W 775 × H 1941 × D 40 mm | 4.964 kg

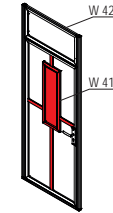
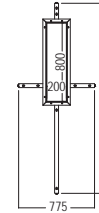

Door cylinder

for W 425 / W 575 / W 805
L 61 × W 42 × H 28 mm



W 514.38

steel

1 × dead lock cylinder, for mounting into door W 425 / W 575 / W 805, incl. 3 × key W 514/S

L 61 × W 42 × H 28 mm | 0.222 kg

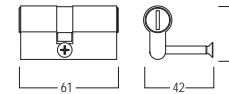

Transport fixation

left
for door W 425M

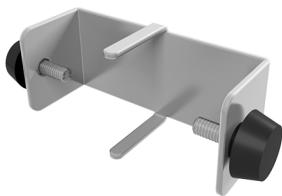

W 417M.20

aluminium/steel

Transport fixation for door element W 425M, consisting of 1 × W 417-oZ and 2 × M6 knurled screw W 464-21

L 90 × W 38 × H 33 mm | 0.096 kg

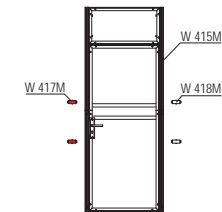
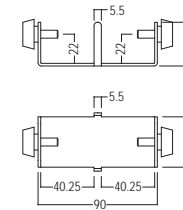

Doors

octawall 40 toolless

Transport fixation

right
for door W 425M

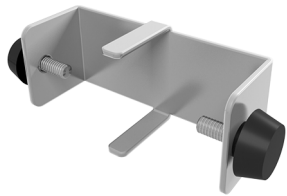

W 418M.20 aluminium/steel

Transport fixation for door element W 415M, consisting of W 417-oZ and 2 × M6 knurled screw W 464-21

L 93 × W 38 × H 33 mm | 0.101 kg

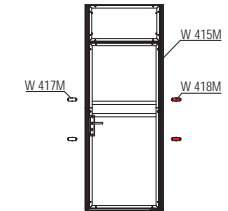
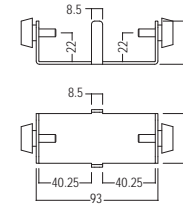

Fabric/Panel/Glass

octawall 40 toolless

Silicone edge

100 meter roll
for fabric



M 1313.50

silicone

for mounting fabric to all tension fabric extrusions, 100 m roll
W 14 × H 3 mm | 5.14 kg

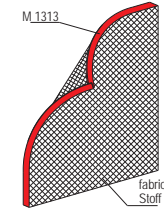
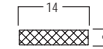

Hook tape

50 meter roll
for mounting of panels



W 840.30

polyamide

for mounting of panels, polyamide, white, self-adhesive, 50 m roll
W 20 × H 2 mm | 0.642 kg

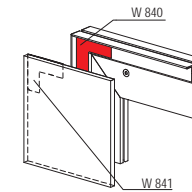
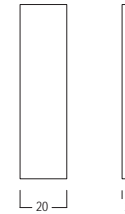

Loop tape

25 meter roll
for mounting of panels



W 841.30

polyamide

for mounting of panels, white, self-adhesive, 25 m roll
W 20 × H 2 mm | 0.391 kg

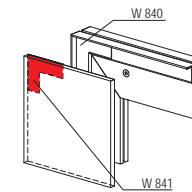

➤ Packaging/Transport

octawall 40 toolless

Transport bag

rolled
for octawall 40 toolless



W 494.90

nylon, black

1 × shoulder bag with hook-and-loop tape for closing, for octawall 40 toolless, incl. adjustable shoulder strap

L 1400 × W 900 × H 5 mm | 3.1 kg

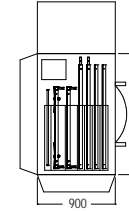

➤ technical information

➤ M-OW-1.1	103
octawall 40 toolless assembly instruction W 402M	
➤ TI-OW-3.2	104
octawall 40 classic, corner extrusion S 382/S381 fabric dimensions	
➤ TI-OW-3.3	105
W 840 / W 841 Hook and loop tape notes	
➤ TI-OW-6.1	106
octawall 40 toolless rotatable foot plate M 1956	
➤ TI-OW-6.2	107
octawall 40 toolless foot plates and adjustable feet	

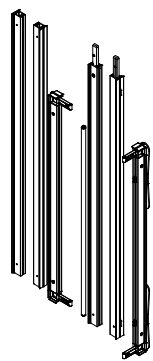

1

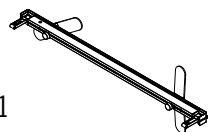

1.1

Tighten knurled head screw!



2

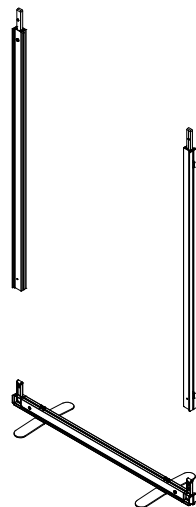

3

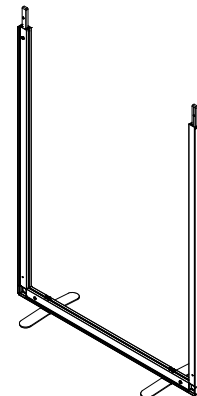

4

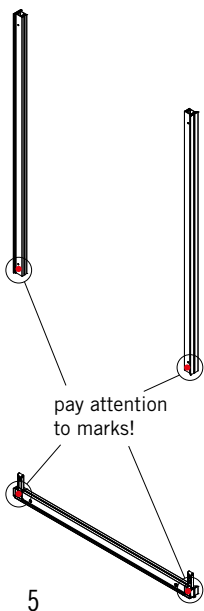
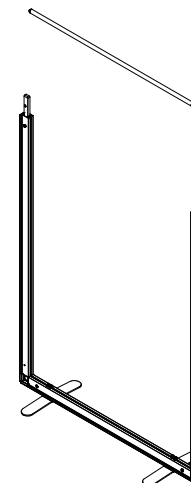

5

pay attention to marks!

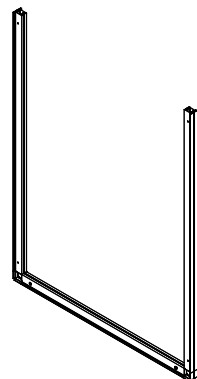
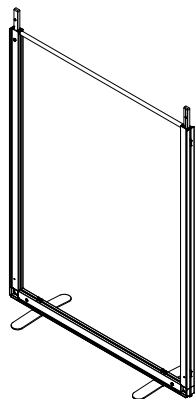

6

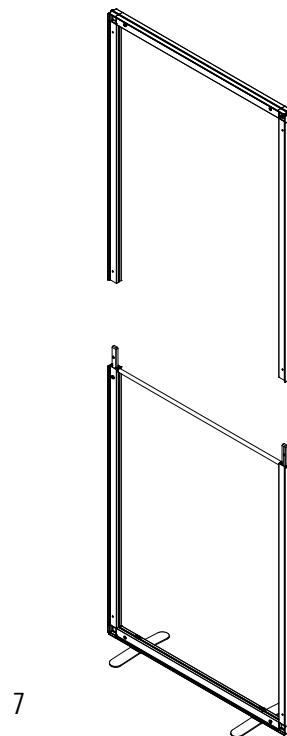
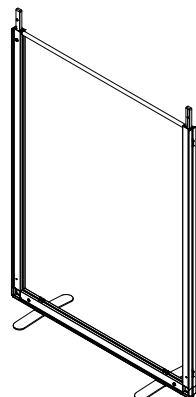

7

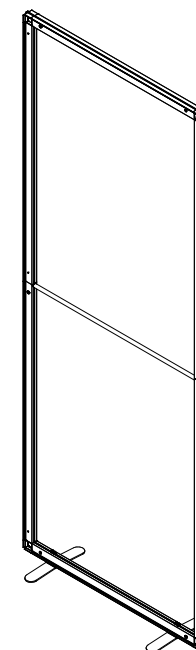
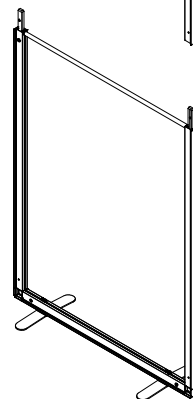

8

M-OW-1.1

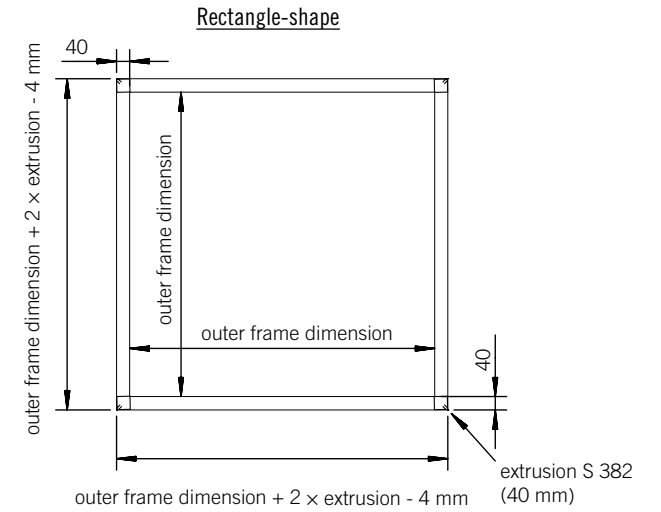
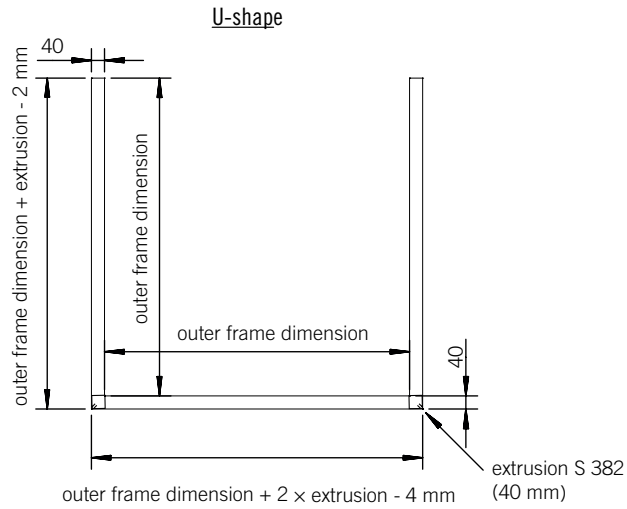
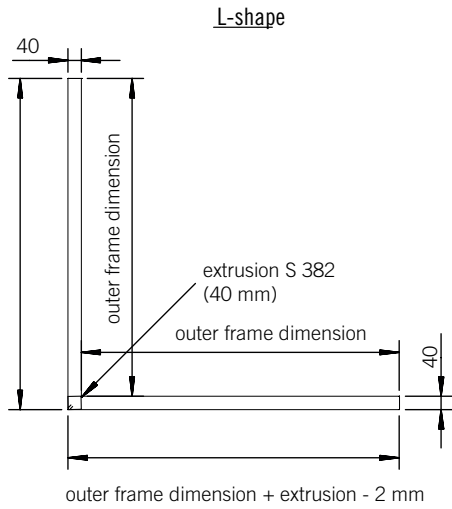

vertical fabric dimension = frame height

Cut of silicone edge

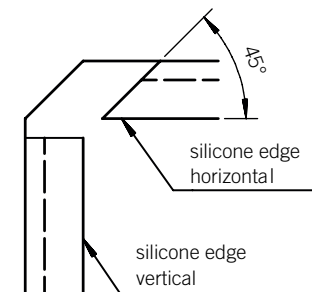

Temperature Resistance

- Temperature range from -10°C to +60°C
- The temperature at which the glue still adheres strongly depends on the surface, the humidity and the applied load

Application/Connection

- Use at room temperature 20°C (+/-5°C)
- Tape with glue and substrate must be at room temperature
- Press firmly together when gluing
- Maximum adherence after 48 hours at room temperature
- Under constant tension or pressure, the glue tends to displace slightly when used with certain fabrics
- The glue is not suitable for reuse

Surface

- Must be free of oil, dirt, dust, moisture, loose particles, monomeric plasticizers, silicones, flaking paint or coating
- Should not be too uneven, fragile, soft or unstable
- Should be suitable for the application of glue
- Should permit good bonding with adhesives, like most metals, wood, ceramics, stone, paper, cardboard, certain fabrics, various hard plastics and foams

Storage/Shelf Life

- In a dry, dark, dust-free and well ventilated room
- At a constant temperature of approx. 20°C (+/-5°C)
- Shelf life with correct storage: 12 months

User Tests/Warranty

- The above information is only for general guidance
- Based on their own tests, users should decide for themselves on the applicability of the fastening

General Instructions for Use

- Do not strain the self-adhesive tape within the first 24 hours after fastening
- Minimum recommended bonding temperature > 10°C
- Degrease the surface, e.g. with alcohol or spirit. The surface must be free of grease, moisture, dust, silicones, etc.
- Remove the protective paper and press the tape firmly in place. Pay particular attention to corners and edges!
- Bonding time: at least 1 hour at room temperature

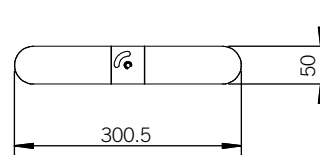
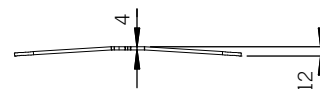
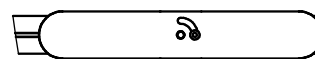
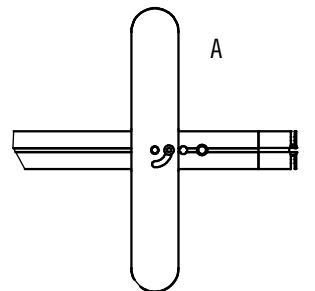
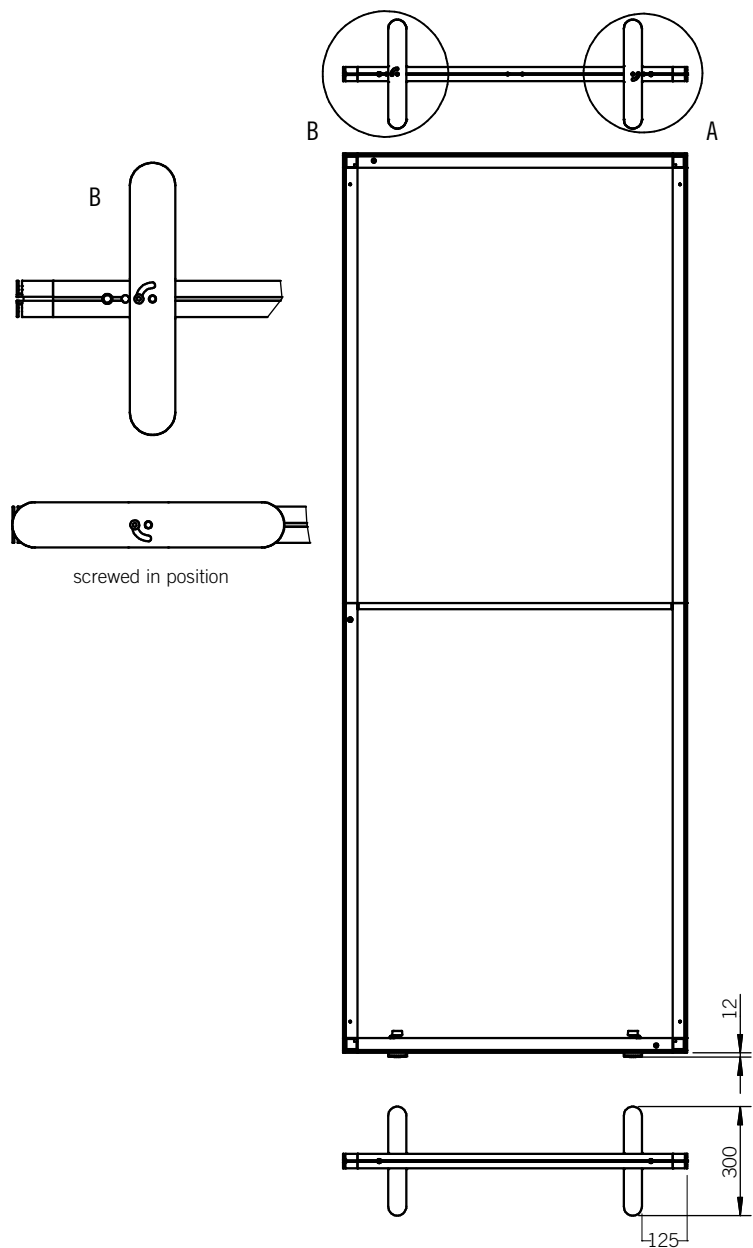

M 1956-oZ to screw in

Screw M 1956-20 with nut PL-3-22-2
don't tighten too hard -
knurled head screw M 1956-3 with
2 washers M 1469-40 tightend slightly

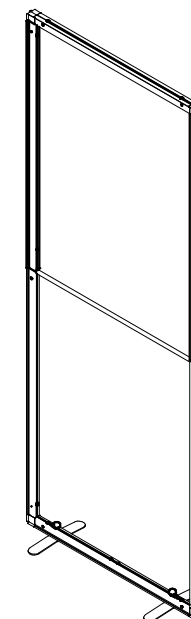
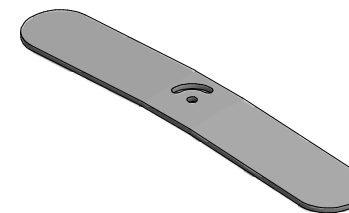
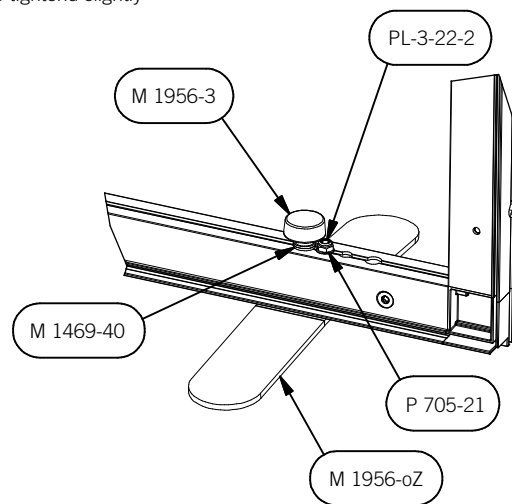

TI-OW-6.1

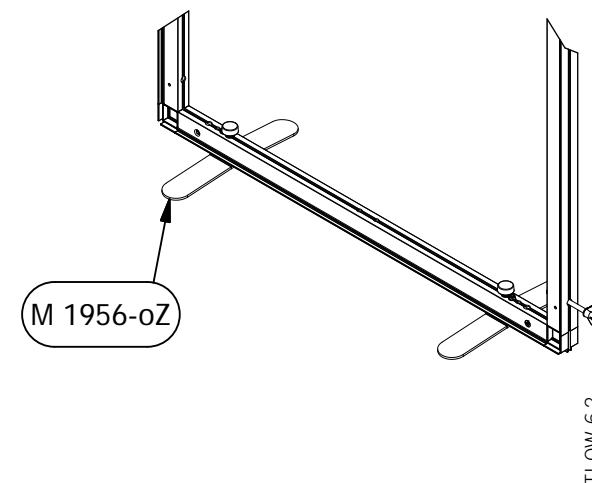
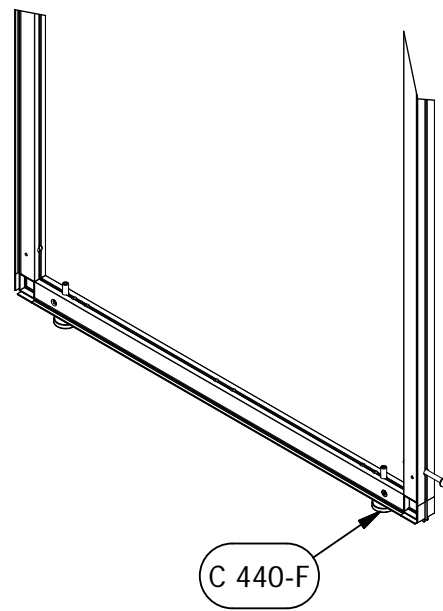
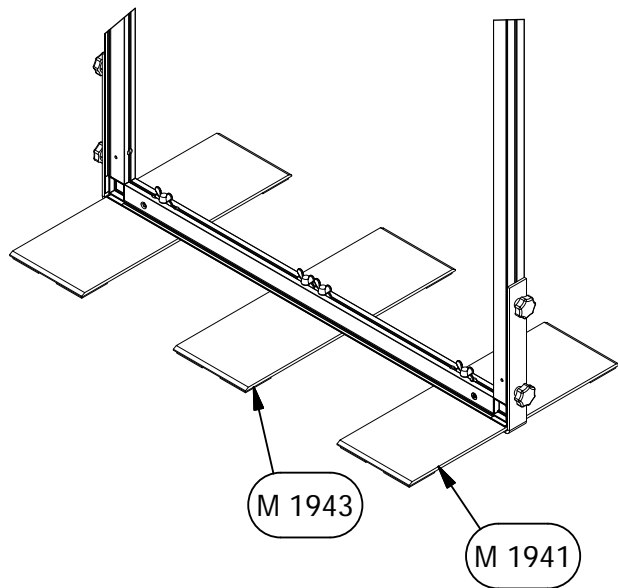

TI-OW-6.2



OCTANORM®-Vertriebs-GmbH

für Bauelemente
Raiffeisenstraße 39
70794 Filderstadt, Germany
T +49 711 77003 0
E info@octanorm.de

Adria

↗ octanormadria.com

Australia

↗ octanorm.com.au

Belgium

↗ octanorm.be

China

↗ octanorm.cn

Emirates

↗ octanormemirates.net

Espana

↗ octanorm.es

France

↗ octanorm.fr

Hellas

↗ octanorm.gr

Italia

↗ octanorm.com

Japan

↗ octanorm.co.jp

México

↗ octanorm.com.mx

Nigeria

↗ it-al.design

Nordic

↗ octanorm.se

North America

↗ octanormna.com

Polska

↗ octanorm.pl

South Africa

↗ octanorm.co.za

UK

↗ octanorm.uk

↗ octanorm.com