

octawall pro

80 mm

↗ Technics 04/26

Frame system for fabric, panel, LED

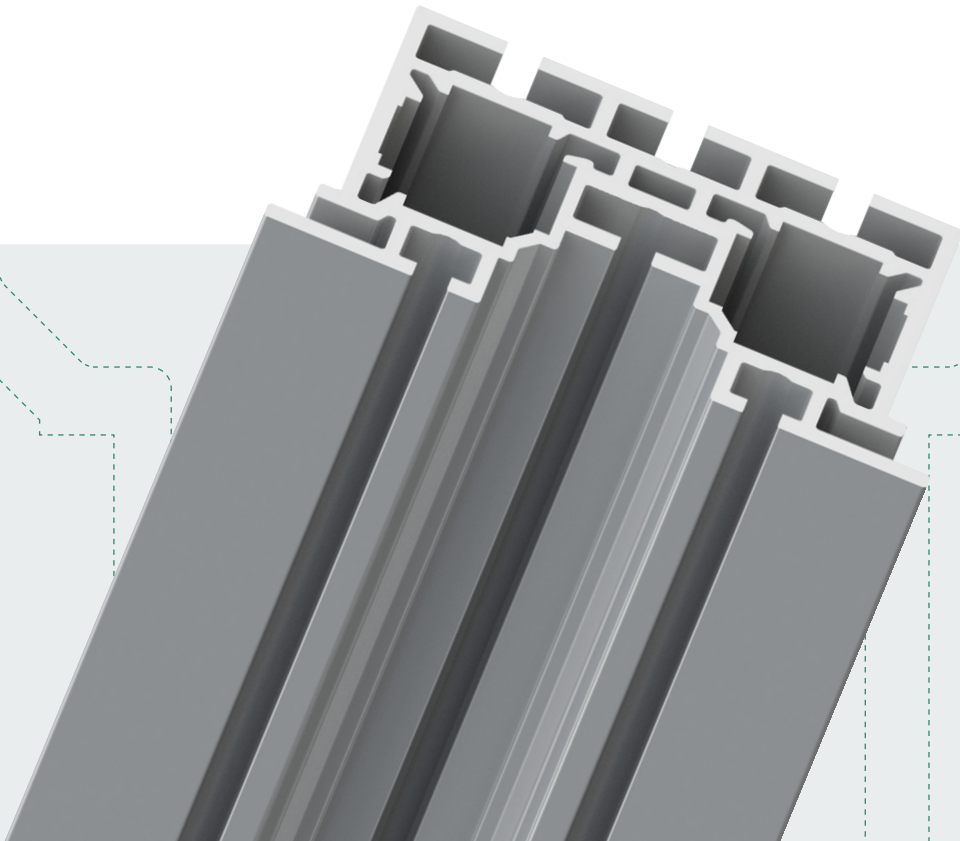

➤ Contents

➤ octawall pro	
➤ Frames	3
➤ Basic parts	10
➤ Accessories	20
➤ Doors	25
➤ LED/Fabric/Panel	28
➤ Electrical parts	34
➤ Packaging/Transport	39
➤ Sets	40
➤ technical information	41

Frames

octawall pro

Frame

for double sided fabric / panel
W 950 × H 2480 × D 80 mm



WP 860-11.01

aluminium

1 × frame made of WP 860 for fabric/panel on both sides, for mounting to frame or upright, with 30 × drill hole for quick connector WP 80-1 or WP 80-2, 8 × threaded hole for adjustable foot WP 80-3 and 8 × outlet for passing cables incl. protection WP 85-8

W 950 × H 2480 × D 80 mm | 13.484 kg

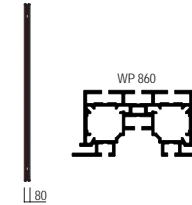
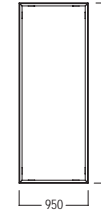

1 Hook tape W 840 and loop tape W 841 (for mounting panels) have to be ordered separately.

1 fabric size = outer frame dimension

Frame

for double sided fabric / panel
W 435 × H 2480 × D 80 mm



WP 860-12.01

aluminium

1 × frame made of WP 860 for fabric/panel on both sides, for mounting to frame or upright, with 20 × drill hole for quick connector WP 80-1 or WP 80-2, 8 × threaded hole for adjustable foot WP 80-3 and 8 × outlet for passing cables incl. protection WP 85-8

W 435 × H 2480 × D 80 mm | 11.402 kg

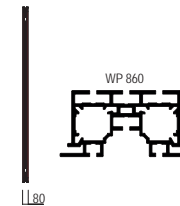

1 Hook tape W 840 and loop tape W 841 (for mounting panels) have to be ordered separately.

1 fabric size = outer frame dimension

Frame

for double sided fabric / panel
W 950 × H 1500 × D 80 mm



WP 860-10.01

aluminium

1 × frame made of WP 860 for fabric/panel on both sides, for mounting to frame or upright, with 20 × drill hole for quick connector WP 80-1 or WP 80-2, 8 × threaded hole for adjustable foot WP 80-3 and 8 × outlet for passing cables incl. protection WP 85-8

W 950 × H 1500 × D 80 mm | 12.044 kg

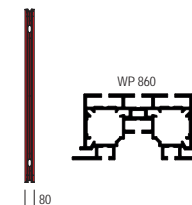
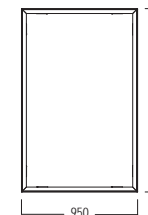

1 Hook tape W 840 and loop tape W 841 (for mounting panels) have to be ordered separately.

1 fabric size = outer frame dimension

Frames

octawall pro

Frame

for double sided fabric / panel
W 435 × H 1500 × D 80 mm



WP 860-13.01

aluminium

1 × frame made of WP 860 for fabric/panel on both sides, for mounting to frame or upright, with 10 × drill hole for quick connector WP 80-1 or WP 80-2, 8 × threaded hole for adjustable foot WP 80-3 and 8 × outlet for passing cables incl. protection WP 85-8

W 435 × H 1500 × D 80 mm | 9 kg

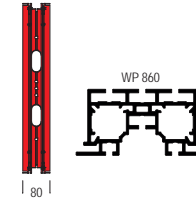
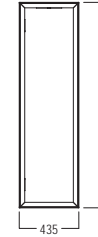

1 Hook tape W 840 and loop tape W 841 (for mounting panels) have to be ordered separately.

1 fabric size = outer frame dimension

Frame

for double sided fabric / panel
W 950 × H 1000 × D 80 mm



WP 860-9.01

aluminium

1 × frame made of WP 860 for fabric/panel on both sides, for mounting to frame or upright, with 24 × drill hole for quick connector WP 80-1 or WP 80-2, 8 × threaded hole for adjustable foot WP 80-3 and 8 × outlet for passing cables incl. protection WP 85-8

W 950 × H 1000 × D 80 mm | 10.766 kg

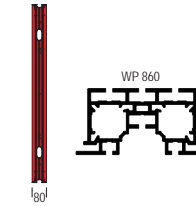
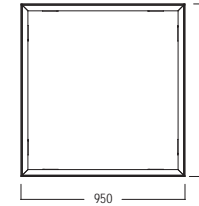

1 Hook tape W 840 and loop tape W 841 (for mounting panels) have to be ordered separately.

1 fabric size = outer frame dimension

Frame

for double sided fabric / panel
W 435 × H 1000 × D 80 mm



WP 860-14.01

aluminium

1 × frame made of WP 860 for fabric/panel on both sides, for mounting to frame or upright, with 14 × drill hole for quick connector WP 80-1 or WP 80-2, 8 × threaded hole for adjustable foot WP 80-3 and 8 × outlet for passing cables incl. protection WP 85-8

W 435 × H 1000 × D 80 mm | 7.732 kg

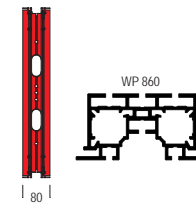
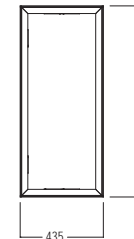

1 Hook tape W 840 and loop tape W 841 (for mounting panels) have to be ordered separately.

1 fabric size = outer frame dimension

Frames

octawall pro

Frame

for double sided fabric / panel
W 950 × H 500 × D 80 mm



WP 860-8.01

aluminium

1 × frame made of WP 860 for fabric/panel on both sides, for mounting to frame or upright, with 16 × drill hole for quick connector WP 80-1 or WP 80-2, 8 × threaded hole for adjustable foot WP 80-3 and 8 × outlet for passing cables incl. protection WP 85-8

W 950 × H 500 × D 80 mm | 8.24 kg

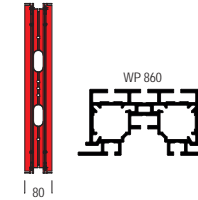
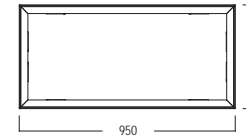

Hook tape W 840 and loop tape W 841 (for mounting panels) have to be ordered separately.

fabric size = outer frame dimension

Frame

for double sided fabric / panel
W 435 × H 500 × D 80 mm



WP 860-15.01

aluminium

1 × frame made of WP 860 for fabric/panel on both sides, for mounting to frame or upright, with 6 × drill hole for quick connector WP 80-1 or WP 80-2, 8 × threaded hole for adjustable foot WP 80-3 and 8 × outlet for passing cables incl. protection WP 85-8

W 435 × H 500 × D 80 mm | 5.196 kg

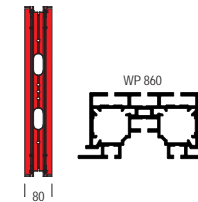
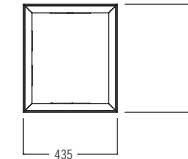

Hook tape W 840 and loop tape W 841 (for mounting panels) have to be ordered separately.

fabric size = outer frame dimension

Frame

for double sided fabric / panel
W 950 × H 480 × D 80 mm



WP 860-7.01

aluminium

1 × frame made of WP 860 for fabric/panel on both sides, for mounting to frame or upright, above door, with 18 × drill hole for quick connector WP 80-1 or WP 80-2, 8 × threaded hole for adjustable foot WP 80-3 and 8 × outlet for passing cables incl. protection WP 85-8

W 950 × H 480 × D 80 mm | 8.24 kg

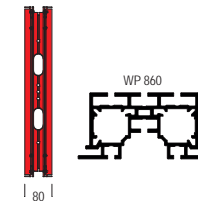
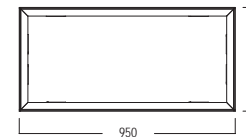

Hook tape W 840 and loop tape W 841 (for mounting panels) have to be ordered separately.

fabric size = outer frame dimension

Frames

octawall pro

Frame

for double sided fabric / panel
W 435 × H 480 × D 80 mm



WP 860-16.01

aluminium

1 × frame made of WP 860 for fabric/panel on both sides, for mounting to frame or upright, with 8 × drill hole for quick connector WP 80-1 or WP 80-2, 8 × threaded hole for adjustable foot WP 80-3 and 8 × outlet for passing cables incl. protection WP 85-8

W 435 × H 480 × D 80 mm | 5.196 kg

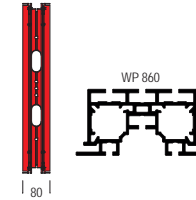
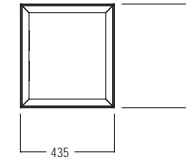

! Hook tape W 840 and loop tape W 841 (for mounting panels) have to be ordered separately.

i fabric size = outer frame dimension

LED adjustment frame

for double sided fabric / panel
W 1500 × H 500 × D 80 mm



WP 860-6.01

aluminium

1 × frame made of WP 860 for fabric/panel on both sides, for mounting to frame or upright, with 16 × drill hole for quick connector WP 80-1 or WP 80-2, 8 × threaded hole for adjustable foot WP 80-3 and 8 × outlet for passing cables incl. protection WP 85-8

W 1500 × H 500 × D 80 mm | 9.508 kg

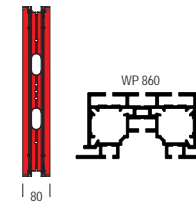
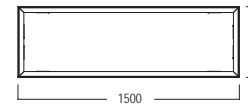

! Hook tape W 840 and loop tape W 841 (for mounting panels) have to be ordered separately.

i fabric size = outer frame dimension

LED adjustment frame

for double sided fabric / panel
W 1000 × H 500 × D 80 mm



WP 860-5.01

aluminium

1 × frame made of WP 860 for fabric/panel on both sides, for mounting to frame or upright, with 20 × drill hole for quick connector WP 80-1 or WP 80-2, 8 × threaded hole for adjustable foot WP 80-3 and 8 × outlet for passing cables incl. protection WP 85-8

W 1000 × H 500 × D 80 mm | 8.24 kg

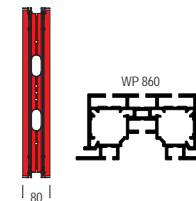
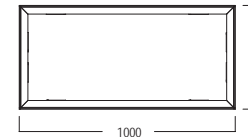

! Hook tape W 840 and loop tape W 841 (for mounting panels) have to be ordered separately.

i fabric size = outer frame dimension

Frames

octawall pro

LED adjustment frame

for double sided fabric / panel
W 500 × H 500 × D 80 mm



WP 860-4.01

aluminium

1 × frame made of WP 860 for fabric/panel on both sides, for mounting to frame or upright, with 12 × drill hole for quick connector WP 80-1 or WP 80-2, 8 × threaded hole for adjustable foot WP 80-3 and 8 × outlet for passing cables incl. protection WP 85-8

W 500 × H 500 × D 80 mm | 5.704 kg

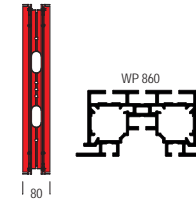
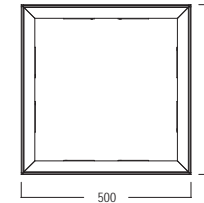

! Hook tape W 840 and loop tape W 841 (for mounting panels) have to be ordered separately.

i fabric size = outer frame dimension

LED adjustment frame

for double sided fabric / panel
W 1500 × H 480 × D 80 mm



WP 860-3.01

aluminium

1 × frame made of WP 860 for fabric/panel on both sides, for mounting to frame or upright, with 18 × drill hole for quick connector WP 80-1 or WP 80-2, 8 × threaded hole for adjustable foot WP 80-3 and 8 × outlet for passing cables incl. protection WP 85-8

W 1500 × H 480 × D 80 mm | 9.508 kg

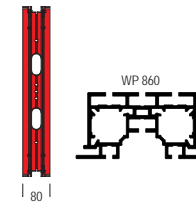
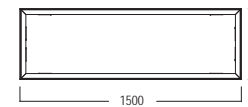

! Hook tape W 840 and loop tape W 841 (for mounting panels) have to be ordered separately.

i fabric size = outer frame dimension

LED adjustment frame

for double sided fabric / panel
W 1000 × H 480 × D 80 mm



WP 860-2.01

aluminium

1 × frame made of WP 860 for fabric/panel on both sides, for mounting to frame or upright, with 22 × drill hole for quick connector WP 80-1 or WP 80-2, 8 × threaded hole for adjustable foot WP 80-3 and 8 × outlet for passing cables incl. protection WP 85-8

W 1000 × H 480 × D 80 mm | 8.24 kg

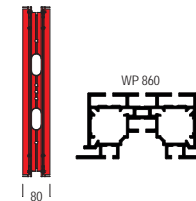
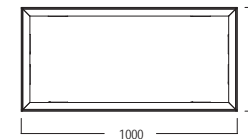

! Hook tape W 840 and loop tape W 841 (for mounting panels) have to be ordered separately.

i fabric size = outer frame dimension

Frames

octawall pro

LED adjustment frame

for double sided fabric / panel
W 500 × H 480 × D 80 mm



WP 860-1.01

aluminium

1 × frame made of WP 860 for fabric/panel on both sides, for mounting to frame or upright, with 14 × drill hole for quick connector WP 80-1 or WP 80-2, 8 × threaded hole for adjustable foot WP 80-3 and 8 × outlet for passing cables incl. protection WP 85-8

W 500 × H 480 × D 80 mm | 5.704 kg

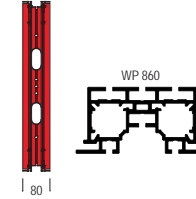
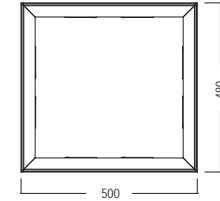

1 Hook tape W 840 and loop tape W 841 (for mounting panels) have to be ordered separately.

1 fabric size = outer frame dimension

frame element curved

for double sided fabric / panel
W 515 × H 2480 × D 515 mm



WP 860-C5.01

aluminium

1 × curved frame made of WP 860 for fabric/panel on both sides, for mounting to frame or upright, with 22 × drill hole for quick connector WP 80-1 or WP 80-2, 8 × threaded hole for adjustable foot WP 80-3 and 4 × lateral outlet for passing cables incl. protection WP 85-8, without hook tape W 840 and loop tape W 841, optional: central cable outlet

W 515 × H 2480 × D 515 mm | 16.236 kg

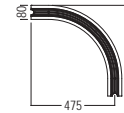

1 When combining several curved frames, deviations may occur at the joints.

1 fabric dimension see technical info

frame element curved

for double sided fabric / panel
W 515 × H 1500 × D 515 mm



WP 860-C4.01

aluminium

1 × curved frame made of WP 860 for fabric/panel on both sides, for mounting to frame or upright, with 12 × drill hole for quick connector WP 80-1 or WP 80-2, 8 × threaded hole for adjustable foot WP 80-3 and 4 × lateral outlet for passing cables incl. protection WP 85-8, without hook tape W 840 and loop tape W 841, optional: central cable outlet

W 515 × H 1500 × D 515 mm | 9.896 kg

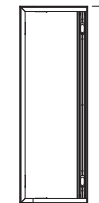
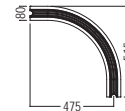

1 When combining several curved frames, deviations may occur at the joints.

1 fabric dimension see technical info

Frames

octawall pro

frame element curved

for double sided fabric / panel
W 515 × H 1000 × D 515 mm



WP 860-C3.01

aluminium

1 × curved frame made of WP 860 for fabric/panel on both sides, for mounting to frame or upright, with 16 × drill hole for quick connector WP 80-1 or WP 80-2, 8 × threaded hole for adjustable foot WP 80-3 and 4 × lateral outlet for passing cables incl. protection WP 85-8, without hook tape W 840 and loop tape W 841, optional: central cable outlet

W 515 × H 1000 × D 515 mm | 8.628 kg

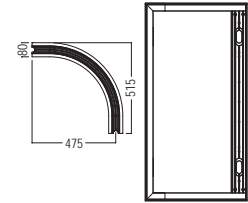

! When combining several curved frames, deviations may occur at the joints.

i fabric dimension see technical info

frame element curved

for double sided fabric / panel
W 515 × H 500 × D 515 mm

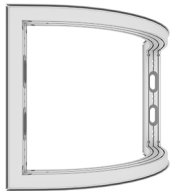

WP 860-C2.01

aluminium

1 × curved frame made of WP 860 for fabric/panel on both sides, for mounting to frame or upright, with 8 × drill hole for quick connector WP 80-1 or WP 80-2, 8 × threaded hole for adjustable foot WP 80-3 and 4 × lateral outlet for passing cables incl. protection WP 85-8, without hook tape W 840 and loop tape W 841, optional: central cable outlet

W 515 × H 500 × D 515 mm | 6.092 kg

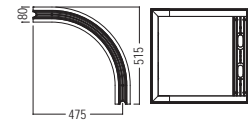

! When combining several curved frames, deviations may occur at the joints.

i fabric dimension see technical info

frame element curved

for double sided fabric / panel
W 515 × H 480 × D 515 mm

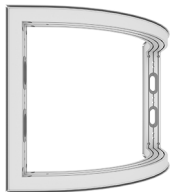

WP 860-C1.01

aluminium

1 × frame made of WP 860 for fabric/panel on both sides, for mounting to frame or upright, with 6 × drill hole for quick connector WP 80-1 or WP 80-2, 8 × threaded hole for adjustable foot WP 80-3 and 4 × lateral outlet for passing cables incl. protection WP 85-8, without hook tape W 840 and loop tape W 841, optional: central cable outlet

W 515 × H 480 × D 515 mm | 5.99 kg

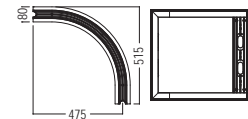

! When combining several curved frames, deviations may occur at the joints.

i fabric dimension see technical info

Basic parts

octawall pro

Frame extrusion

for double sided fabric / panel
L 6000 x W 80 x H 40 mm

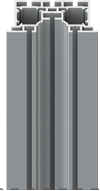

WP 860.01

aluminium

for mounting either fabric (with silicone edge M 1313) or panels (with hook tape W 840 and loop tape W 841)

L 6000 x W 80 x H 40 mm | 11.918 kg

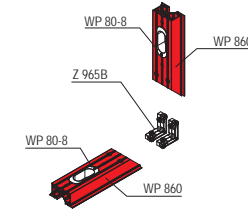
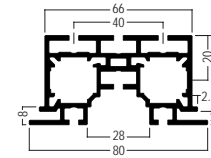

1 Hook tape W 840 and loop tape W 841 (for mounting panels) have to be ordered separately.

Spacer beam

for frames of WP 860
custom size

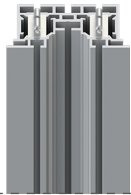

WP 860-Z10SO.01

aluminium

1 x beam of frame extrusion WP 860, as an addition between two frame elements, incl. 4 x built-in tension lock Z 961/8, length = 160 - 1000 mm

custom size |

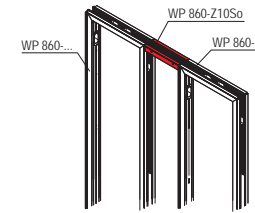
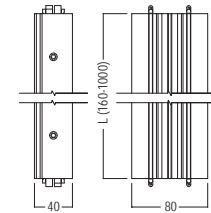

1 L = 160 - 1000 mm

1 custom size: please advise length when placing the order

Corner upright extrusion

90°
for fabric

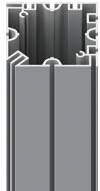

WP 850.01

aluminium

for connecting octawall pro fabric frames, fabric can be tensioned over the extrusion up to the corner

L 6000 x W 80 x H 80 mm | 16.48 kg

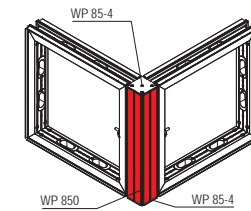
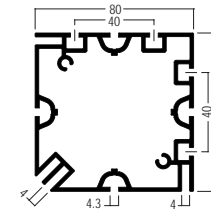

Basic parts

octawall pro

Corner upright

90°
for 2480 mm frames



WP 850-248.01

aluminium

1 × corner upright of WP 850 for connecting octawall pro fabric frames height 2480 mm, fabric can be tensioned over the extrusion up to the corner, incl. 2 × end plate WP 85-4

L 80 × W 80 × H 2480 mm | 6.8 kg

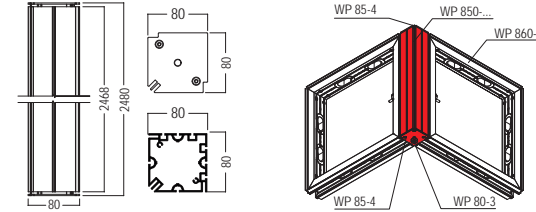

Corner upright

90°
for 1500 mm frames



WP 850-150.01

aluminium

1 × corner upright of WP 850 for connecting octawall pro fabric frames height 1500 mm, fabric can be tensioned over the extrusion up to the corner, incl. 2 × end plate WP 85-4

L 80 × W 80 × H 1500 mm | 4.2 kg

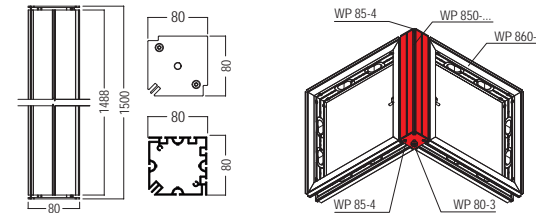

Corner upright

90°
for 1000 mm frames



WP 850-100.01

aluminium

1 × corner upright of WP 850 for connecting octawall pro fabric frames height 1000 mm, fabric can be tensioned over the extrusion up to the corner, incl. 2 × end plate WP 85-4

L 80 × B 80 × H 1000 mm | 3.1 kg

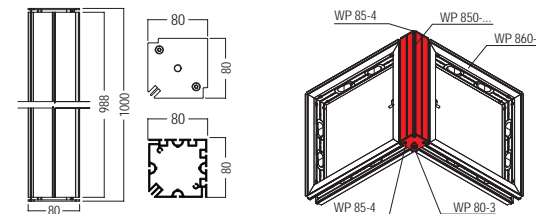

Basic parts

octawall pro

Corner upright

90°
for 500 mm frames



WP 850-50.01

aluminium

1 × corner upright of WP 850 for connecting octawall pro fabric frames height 500 mm, fabric can be tensioned over the extrusion up to the corner, incl. 2 × end plate WP 85-4

L 80 × W 80 × H 500 mm | 1.685 kg

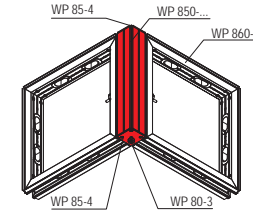
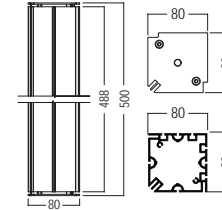

Corner upright

90°
for 480 mm frames



WP 850-48.01

aluminium

1 × corner upright of WP 850 for connecting octawall pro fabric frames height 480 mm, fabric can be tensioned over the extrusion up to the corner, incl. 2 × end plate WP 85-4, L 80 × W 80 × H 480 mm

L 80 × W 80 × H 480 mm | 1.632 kg

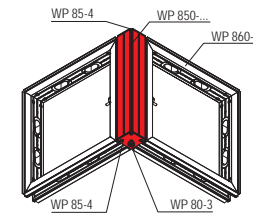
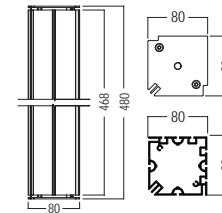

T-extrusion

for 90° connection
for double sided fabric / panel



WP 820.01

aluminium

mounting frames at 90° at any position, for mounting either fabric (with silicone edge M 1313) or panels, installation of 4 × tension lock Z 951/8 possible

L 6000 × W 122 × H 28 mm | 11.7 kg

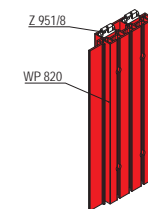
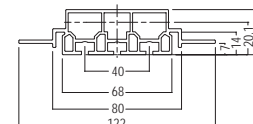

Basic parts

octawall pro

T-extrusion

for 90° connection
for 2480 mm frames



WP 820-248.01

aluminium

1 × connection extrusion of WP 820 for mounting frames with a height of 2480 mm at 90° at any position, for mounting either fabric (with silicone edge M 1313) or panels, incl. 4 × tension lock Z 951/8

L 2400 × W 122 × H 28 mm | 5.1 kg

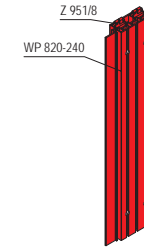
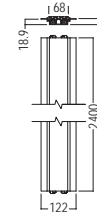

T-extrusion

for 90° connection
for 1500 mm frames



WP 820-150.01

aluminium

1 × connection extrusion of WP 820 for mounting frames with a height of 1500 mm at 90° at any position, for mounting either fabric (with silicone edge M 1313) or panels, incl. 4 × tension lock Z 951/8

L 1420 × W 122 × H 28 mm | 3.2 kg

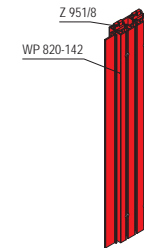
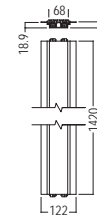

T-extrusion

for 90° connection
for 1000 mm frames



WP 820-100.01

aluminium

1 × connection extrusion of WP 820 for mounting frames with a height of 1000 mm at 90° at any position, for mounting either fabric (with silicone edge M 1313) or panels, incl. 4 × tension lock Z 951/8

L 920 × W 122 × H 28 mm | 2.2 kg

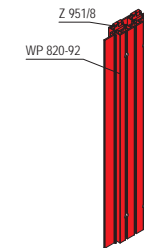
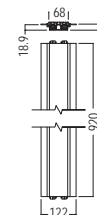

Basic parts

octawall pro

T-extrusion

for 90° connection
for 500 mm frames



WP 820-50.01

aluminium

1 × connection extrusion of WP 820 for mounting frames with a height of 500 mm at 90° at any position, for mounting either fabric (with silicone edge M 1313) or panels, incl. 4 × tension lock Z 951/8

L 420 × W 122 × H 28 mm | 1.2 kg

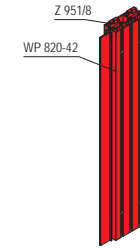
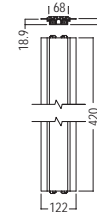

T-extrusion

for 90° connection
for 480 mm frames



WP 820-48.01

aluminium

1 × connection extrusion of WP 820 for mounting frames with a height of 480 mm at 90° at any position, for mounting either fabric (with silicone edge M 1313) or panels, incl. 4 × tension lock Z 951/8

L 400 × W 122 × H 28 mm | 1.2 kg

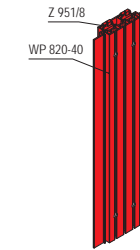
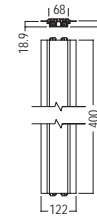

Corner upright extrusion

135°
for fabric

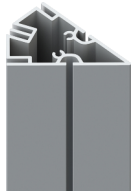

WP 840.01

aluminium

for connecting octawall pro fabric frames at 135° angle, fabric can be tensioned over the extrusion up to the corner

L 6060 × W 80 × H 40 mm | 11.28 kg

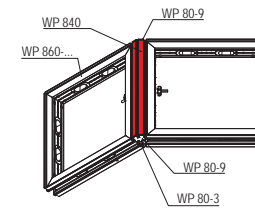
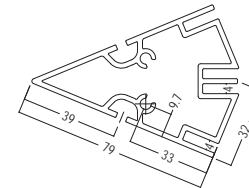

Basic parts

octawall pro

Corner upright

135°
for 2480 mm frames



WP 840-248.01

aluminium

1 × corner upright of WP 840 for connecting octawall pro fabric frames with a height of 2480 mm at 135° angle, fabric can be tensioned over the extrusion up to the corner, incl. 2 × end plate WP 80-9

L 40 × W 80 × H 2480 mm | 4.7 kg

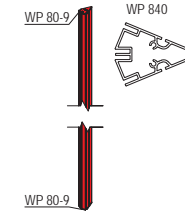

Corner upright

135°
for 1500 mm frames



WP 840-150.01

aluminium

1 × corner upright of WP 840 for connecting octawall pro fabric frames with a height of 1500 mm at 135° angle, fabric can be tensioned over the extrusion up to the corner, incl. 2 × end plate WP 80-9

L 40 × W 80 × H 1500 mm | 3 kg

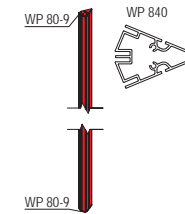

Corner upright

135°
for 1000 mm frames



WP 840-100.01

aluminium

1 × corner upright of WP 840 for connecting octawall pro fabric frames with a height of 1000 mm at 135° angle, fabric can be tensioned over the extrusion up to the corner, incl. 2 × end plate WP 80-9

L 40 × W 80 × H 1000 mm | 2.7 kg

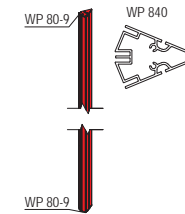

Basic parts

octawall pro

Corner upright

135°
for 500 mm frames



WP 840-50.01

aluminium

1 × corner upright of WP 840 for connecting octawall pro fabric frames with a height of 500 mm at 135° angle, fabric can be tensioned over the extrusion up to the corner, incl. 2 × end plate WP 80-9

L 40 × W 80 × H 500 mm | 1.1 kg

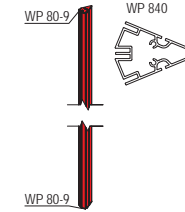

Corner upright

135°
for 480 mm frames



WP 840-48.01

aluminium

1 × corner upright of WP 840 for connecting octawall pro fabric frames with a height of 480 mm at 135° angle, fabric can be tensioned over the extrusion up to the corner, incl. 2 × end plate WP 80-9, L 40 × W 80 × H 480 mm

L 40 × W 80 × H 480 mm | 1.1 kg

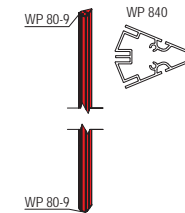

Corner upright extrusion

90° corner, round
L 6000 × W 120 × H 120 mm

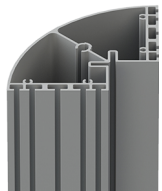

M 260.01

aluminium

for connecting extrusions with width 16, 40, 80, 120 mm, octawall pro or octawall 40 frames, fabric can be stretched over the extrusion

L 6000 × W 120 × H 120 mm | 25.5 kg

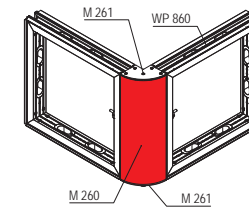
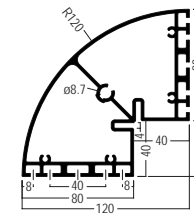

Basic parts

octawall pro

Quick connector

Set
for octawall frames

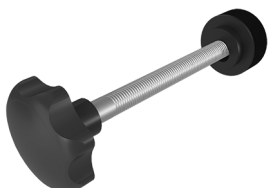

WP 80-1.90

steel

M8, for connecting frame elements octawall
L 136 × W 40 × H 40 mm | 0.099 kg

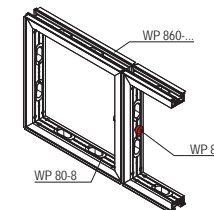
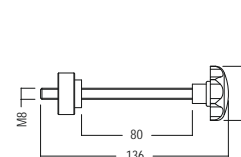

Caution: check existing connections after transport

Quick connector

Set
for uprights WP 850/WP 840



WP 80-2.90

steel

M8, for connecting frame elements to corner upright extrusion WP 850/WP 840 and for mounting of cover extrusion WP 830
L 97 × W 30 × H 30 mm | 0.067 kg

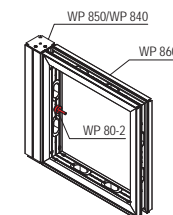
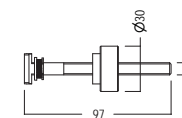

Caution: check existing connections after transport

Quick connector

Set
for uprights WP 850/WP 840



WP 80-23.37

steel

M8, for connecting frame elements to corner upright extrusion WP 850/WP 840 and for mounting of cover extrusion WP 830
L 84 × W 30 × H 30 mm | 0.098 kg

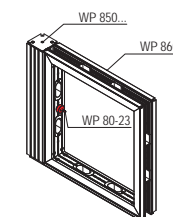
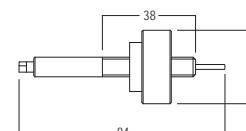

Caution: check existing connections after transport

Basic parts

octawall pro

Corner connector

90°
lock chamber 21 × 12 mm



Z 965B.00

zinc die cast

90°, for extrusions with lock chamber 21 × 12 mm, incl. 2 × hex-star screw E 111 and E 111/20

L 55 × W 21 × H 12 mm | 0.076 kg

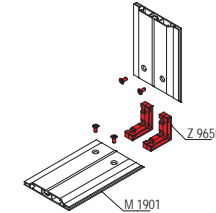
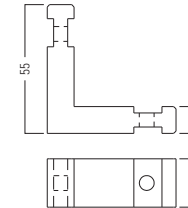

1 steep thread

Corner connector

90°
lock chamber 21 × 12 mm

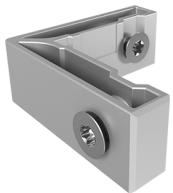

Z 965MB.00

zinc die cast

90°, for extrusions with lock chamber 21 × 12 mm, incl. 2 × hex-star screw E 111-m and 1510-20

L 55 × W 21 × H 12 mm | 0.076 kg

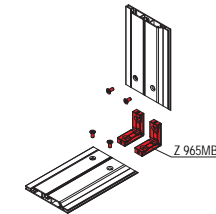
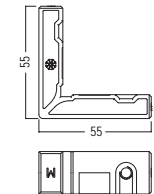

1 metric thread

Adaptor

for octawall pro
for extr. 80 mm

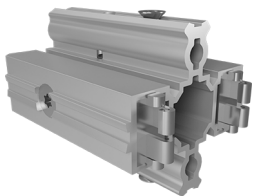

WP 1103.00

aluminium

Aluminium for square extrusions 80 mm, for connection to octawall pro, with 2 × tension lock Z 961/13 and 2 × countersunk screw M 1100/20 (M5)

L 80 × W 57 × H 57 mm | 0.108 kg

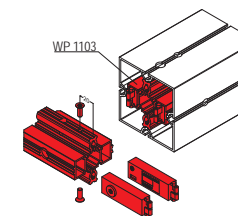
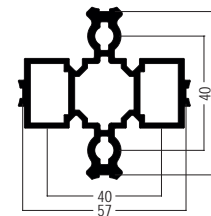

Basic parts

octawall pro

Tension lock

8 mm
L 70 × W 20 × H 12 mm

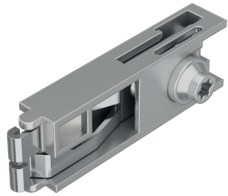

Z 961/8.00

zinc die cast/steel

8 mm, for all beam extrusions with cross- or T-lock chamber 21 × 12 mm

L 70 × W 20 × H 12 mm | 0.054 kg

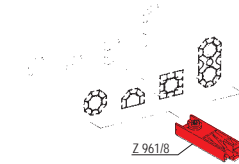
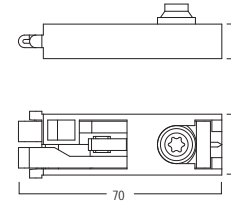

Tension lock

13 mm
L 70 × W 21 × H 13 mm



Z 961/13.00

zinc die cast/steel

13 mm, for all beam extrusions with lock chamber 21 × 12 mm as well as in conjunction with adaptor Z 161/A, for beam extrusions with lock chamber 39 × 12 mm

L 70 × W 21 × H 13 mm | 0.052 kg

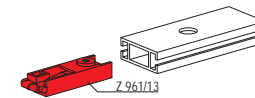
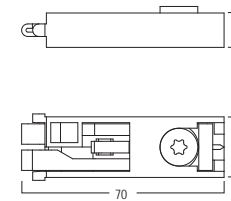

Accessories

octawall pro

Adjustable foot

M10
for frame elements



WP 80-3.37

steel

for installation in frame elements with M10 thread, fully retractable in the function channel of octawall pro frames

L 24 × W 24 × H 80 mm | 0.06 kg

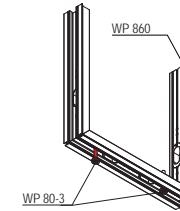
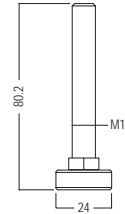

Base plate

long
for frame elements



WP 2450.21

steel

for freestanding octawall pro frames, 3 different mounting positions possible, can be used right/left/center, with 1 × WP 2472 angle bracket and 1 × WP 2476 mounting accessories, max. frame height = 2500 mm

L 576 × W 192 × H 122 mm | 5.699 kg

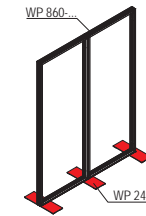
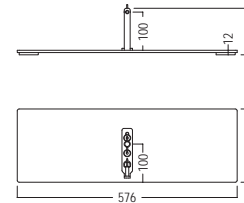

max. frame height = 2500 mm

Base plate

short
for frame elements

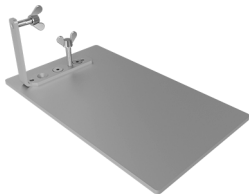

WP 2460.21

steel

for freestanding octawall pro frames, 6 different mounting positions possible, can be used right/left/center, with 1 × WP 2472 angle bracket and 1 × WP 2476 mounting accessories, max. frame height = 2500 mm

L 328 × W 192 × H 122 mm | 3.314 kg

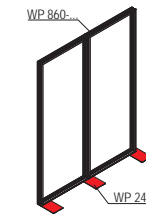
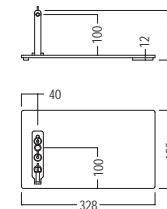

max. frame height = 2500 mm

Accessories

octawall pro

End plate

for extrusion WP 800
for fabric corner 90°



WP 85-4.21

steel

for corner extrusion WP 850, for fabric corner 90°, to create top and bottom horizontal fabric groove, with thread M10 for installation of adjustable foot

L 80 × W 80 × H 6 mm | 0.178 kg

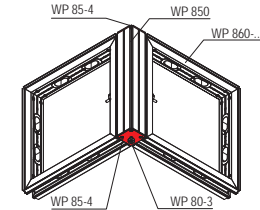
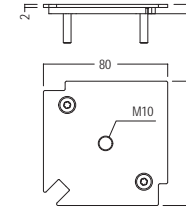

End plate

for extrusion WP 840
for fabric corner 135°

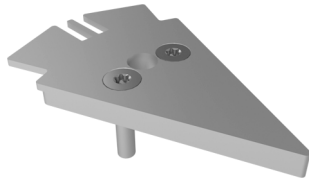

WP 80-9.21

steel

for mounting to corner upright extrusion WP 840, for fabric corner 135°, to create top and bottom horizontal fabric groove, with thread M10 for installation of adjustable foot

L 50 × W 83 × H 6 mm | 0.856 kg

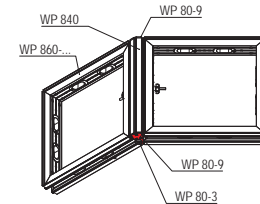
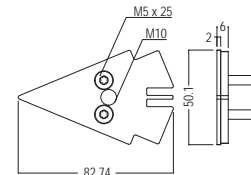

End plate

for 80 mm extrusions
for M 260



M 261.21

steel

for Quarter-round extrusion M 260 in connection with 80 mm extrusions, to create top and bottom horizontal fabric groove, with drilling $\varnothing 11$ mm dia. for adjustable foot

L 120 × W 120 × H 6 mm | 0.335 kg

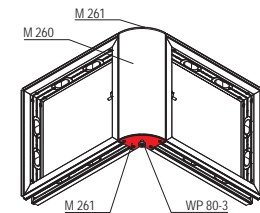
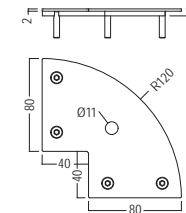

Accessories

octawall pro

End plate

for 120 mm extrusions
for M 260

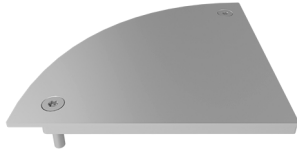

M 271.21

steel

for Quarter-round extrusion M 260 in connection with 120 mm extrusions, to create top and bottom horizontal fabric groove

L 120 × W 120 × H 6 mm | 0.45 kg

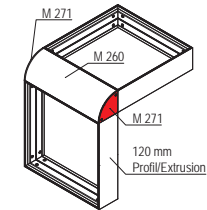
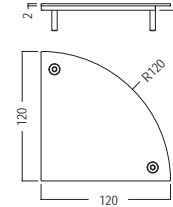

Monitor mount

for 32" - 63"
for frames W 950 mm

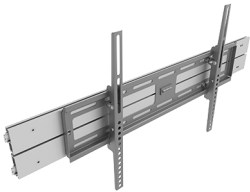

E 196.90

aluminium/steel

for attachment between two uprights with system groove 4.3 mm or frames W 950 mm, for one sided monitor solutions of LCD screens 32" - 63" VESA 50/50 to 600/400, incl. 1 × beam extrusion M 1340, 870 mm long, with 2 × tension lock Z 961/13, 2 × tension lock retractable Z 951/13, 2 × mounting bracket with universal slots and mounting hardware

L 870 × W 53 × H 510 mm | 3.441 kg

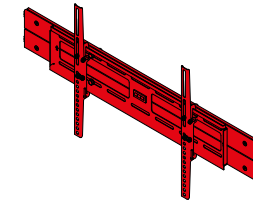
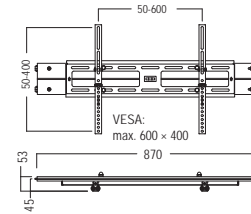

i Monitor can be mounted straight or at an angle of 10° max

Cover extrusion

for extrusion WP 860
L 6000 × W 80 × H 9 mm



WP 830.01

aluminium

to cover frame extrusion WP 860, fastening with WP 80-2 hammer-head screw

L 6000 × W 80 × H 9 mm | 3.58 kg

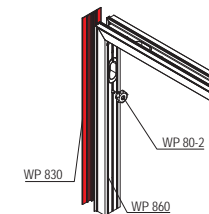
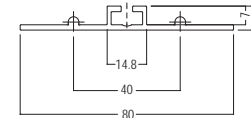

i only in connection with hammerhead screw WP 80-2

Accessories

octawall pro

Cover extrusion

for extrusion WP 860
L 2480 × W 80 × H 9 mm



WP 830-248.01

aluminium

to cover frame extrusion WP 860 of frames with 2480 mm height,
fastening with WP 80-2 hammer-head screw

L 2480 × W 80 × H 9 mm | 1.465 kg

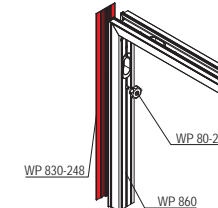
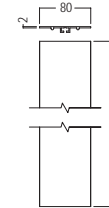

Attention:
Hammerhead screw
WP 80-2 is required for
mounting

Cover extrusion

for extrusion WP 860
L 1500 × W 80 × H 9 mm



WP 830-150.01

aluminium

to cover frame extrusion WP 860 of frames with 1500 mm height,
fastening with WP 80-2 hammer-head screw

L 1500 × W 80 × H 9 mm | 0.886 kg

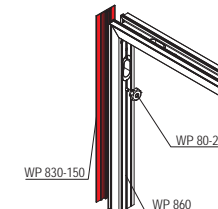
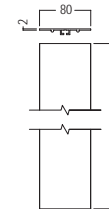

Attention:
Hammerhead screw
WP 80-2 is required for
mounting

Cover extrusion

for extrusion WP 860
L 1000 × W 80 × H 9 mm



WP 830-100.01

aluminium

to cover frame extrusion WP 860 of frames with 1000 mm height,
fastening with WP 80-2 hammer-head screw

L 1000 × W 80 × H 9 mm | 0.591 kg

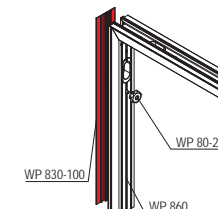
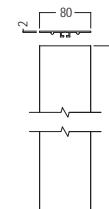

Attention:
Hammerhead screw
WP 80-2 is required for
mounting

Accessories

octawall pro

Cover extrusion

for extrusion WP 860
L 500 × W 80 × H 9 mm



WP 830-50.01

aluminium

to cover frame extrusion WP 860 of frames with 500 mm height,
fastening with WP 80-2 hammer-head screw

L 500 × W 80 × H 9 mm | 0.298 kg

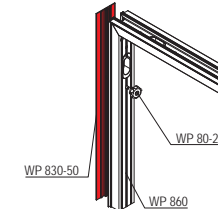
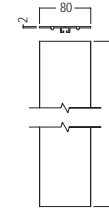

Attention:
Hammerhead screw
WP 80-2 is required for
mounting

Cover extrusion

for extrusion WP 860
L 480 × W 80 × H 9 mm



WP 830-48.01

aluminium

to cover frame extrusion WP 860 of frames with 480 mm height,
fastening with WP 80-2 hammer-head screw

L 480 × W 80 × H 9 mm | 0.284 kg

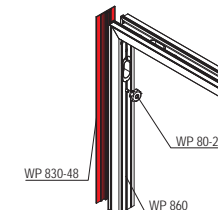
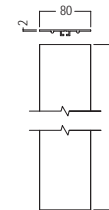

Attention:
Hammerhead screw
WP 80-2 is required for
mounting

Doors

octawall pro

Sliding door

opening W 950 × H 2500 mm
W 1975 × H 2500 × D 80 mm



W 420.01

aluminium

1 × door element made of W 906 for fabric and panel on both sides, can be attached toolfree to the system groove of the octawall 40 frame with hammer head screws, for installation in opening with clear dimensions W 950 × H 2500 mm, sliding door dimensions W 990 × H 2480 × D 40 mm

W 1975 × H 2500 × D 80 mm | 8.099 kg

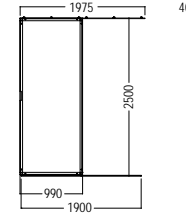

fabric dimension = outer frame dimension

Door set

for 80 mm
W 950 × H 2500 × D 80 mm



W 805-SET.01 | .03

aluminium/steel

1 × door element made of M 2120/W 906, for fabric/panel on both sides, DIN left/right, inward/outward opening, door leaf flush with door leaf frame on the outside or inside, incl. door leaf frame and dead lock cylinder W 514, without hook tape W 840, outer frame dimensions door leaf frame: 908 × 2442 mm

W 950 × H 2500 × D 80 mm | 18.222 kg

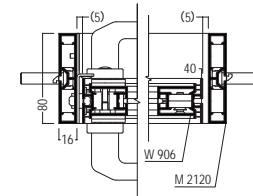
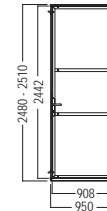

Only use silicone edge 12 × 3 mm for door leaf frame

fabric dimension = outer frame dimension

Window element

for W 805/W405
W 828 × H 2362 × D 40 mm

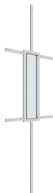

W 809.01

aluminium

1 × window element W 906 for fabric/panel on both sides, for installation in door element W 805, window cut-out: W 200 × H 800 mm

W 828 × H 2362 × D 40 mm | 7.07 kg

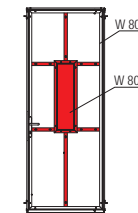
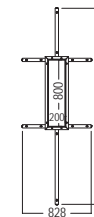

Only use silicone edge 12 × 3 mm for door leaf frame

Doors

octawall pro

Door set

for 40/80/120 mm
W 950 × H 2500 × D 40 mm



W 575-SET.01

aluminium/steel

1 × door element made of W 906, for fabric/panel on both sides, DIN left/right, inward/outward opening, incl. doorleafframe, dooruprightframe, threshold plate and door frame (top), hook tape W 840, extrusion connector E 438 and dead lock cylinder W 514, outer frame dimensions: door leaf frame: 855 × 2021 mm, door frame (top): 870 × 450 mm

W 950 × H 2500 × D 40 mm | 18.222 kg

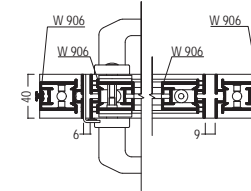
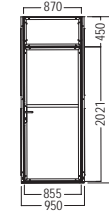

Only use silicone edge 12 × 3 mm for doorleafframe

fabric dimension = outer frame dimension

Door

for 40/80/120 mm
40 mm, custom size



W 575SO.01

aluminium/steel

1 × door element made of W 906, for fabric/panel on both sides, DIN left/right, inward/outward opening, incl. doorleafframe, dooruprightframe, threshold plate and door frame (top), hook tape W 840, extrusion connector E 438, without dead lock cylinder W 514, 40 mm, custom size: please specify door element width and door element height when ordering

40 mm, custom size |

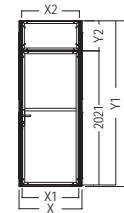

X = 700-1080 mm
X1 = 605-985 mm
X2 = 620-1000 mm

Y = 2400-3000 mm
Y1 = 2380-2980 mm
Y2 = 350-950 mm

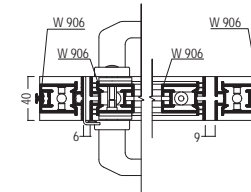

Only use silicone edge 12 × 3 mm for doorleafframe

fabric dimension = outer frame dimension

Door Mounting Set

for door W 575
integration into 80 mm



W 575-080.01

aluminium

for flush or 20 mm projecting connection of the doorelement W 575 to maxima 80 or octawall pro, consisting of: 6 × mounting bracket W 575-080A, 6 × retractable sliding block C 60 590, 12 × countersunk screw (M4) VA 1058/20

L 40 × W 32 × H 60 mm | 0.146 kg

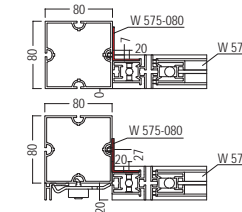
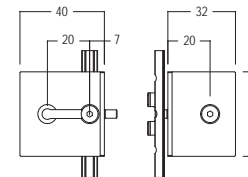

Door cylinder

for W 425 / W 575 / W 805
L 61 × W 42 × H 28 mm



W 514.38

steel

1 × dead lock cylinder, for mounting into door W 425 / W 575 / W 805, incl. 3 × key W 514/S

L 61 × W 42 × H 28 mm | 0.222 kg

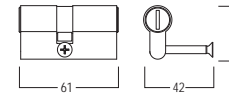

LED panel fastener

Infiled LED inspire 2.6 DB pro
L 51 × W 42 × H 18 mm



WP 80-5.37

steel

for mounting Infiled LED inspire 2.6 DB pro panel to frame extrusion WP 860

L 51 × W 42 × H 18 mm | 0.091 kg

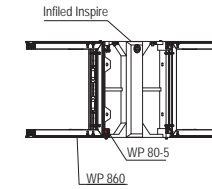
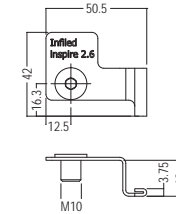

LED panel fastener

Unilumin LED UPad4
L 65 × W 28 × H 12 mm



WP 80-6.37

steel

for mounting Unilumin UPad4 LED panel to frame extrusion WP 860

L 65 × W 28 × H 12 mm | 0.093 kg

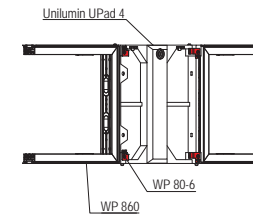
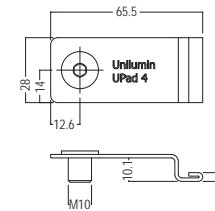

LED panel fastener

Absen DW LED
L 66 × W 28 × H 12 mm



WP 80-7.37

steel

for mounting Absen DW LED panel to frame extrusion WP 860

L 66 × W 28 × H 12 mm | 0.093 kg

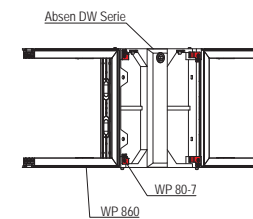
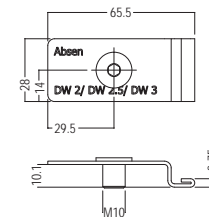

LED panel fastener

Infiled inspire/Leyard LN
L 107.5 × B 107.5 × H 21 mm



WP 80-56.37

steel

for mounting Leyard LN1.9 panels with M8 flat screws N 000009 in frame extrusion WP 860, or for mounting Infiled LED inspire 2.6 DB panels with M10 flat screws WP 80-51 and washers N 000010 in frame extrusion WP 860

L 107.5 × B 107.5 × H 21 mm | 0.797 kg

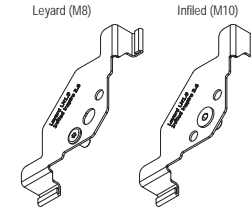
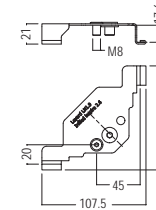

Silicone edge

100 meter roll
for fabric



M 1313.50

silicone

for mounting fabric to all tension fabric extrusions, 100 m roll

W 14 × H 3 mm | 5.14 kg

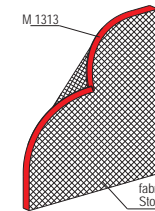
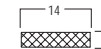

Hook tape

50 meter roll
for mounting of panels



W 840.30

polyamide

for mounting of panels, polyamide, white, self-adhesive, 50 m roll

W 20 × H 2 mm | 0.642 kg

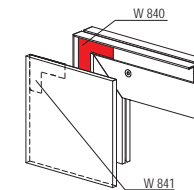

Loop tape

25 meter roll
for mounting of panels



W 841.30

polyamide

for mounting of panels, white, self-adhesive, 25 m roll

W 20 × H 2 mm | 0.391 kg

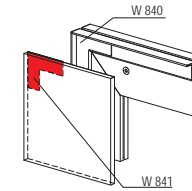
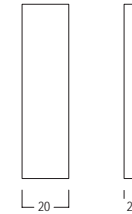

Panel retainer

for hanging panels
for WP 892

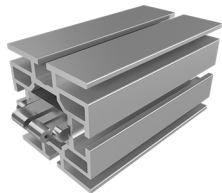

WP 891.01

aluminium

for hanging panels, for hook WP 892, to be installed in the system groove, incl. 1 × tension lock Z 961-8

L 70 × W 40 × H 40 mm | 0.149 kg

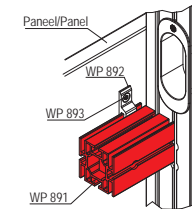
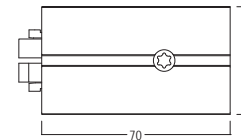

Slotted insert rail set

for hanging panels
L 2399 × W 30 × H 30 mm



WP 890-2480.01

aluminium/steel

1 × extrusion made of WP 890HZ with system grid 500 mm, for hanging panels on octawall pro frame with 2480 mm height, incl. 6 × fixing set M6 WP 895

L 2399 × W 30 × H 30 mm | 0.88 kg

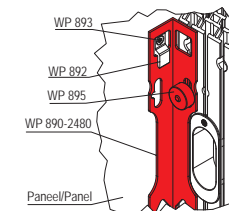
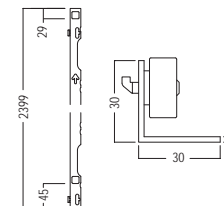

Fixing set

for hanging panels
for WP 890-...

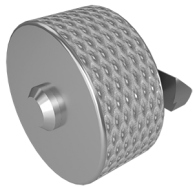

WP 895.37

steel/plastic

for mounting perforated rails WP 890-... to system groove 4.3 mm,
incl. 1 × hammerhead screw M6 M 1348-Ha

L 21 × W 22 × H 22 mm | 0.032 kg

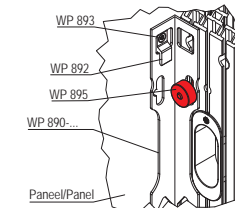
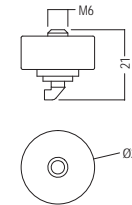

Mounting hook

PU 20 pcs
for hanging panels



WP 892.00

aluminium

with system distance 32 mm, for screwing onto a panel with Euro
screw WP 893 (pre-drilled Ø 5 mm) or wood screw (screws not
included), 2 screws required per hook, PU 20 pcs

L 48 × W 12 × H 8 mm | 0.1 kg

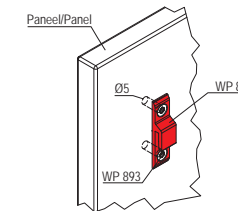
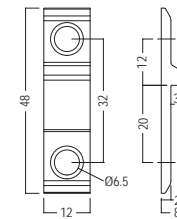

**2 screws required per
hook.**

Screw

PU 100 pcs
for WP 892



WP 893.38

steel, nickel plated

for Ø 5 mm hole, for screwing on WP 892 hook, PU 100 pcs.

L 10.5 × W 7.8 × H 7.8 mm | 0.2 kg

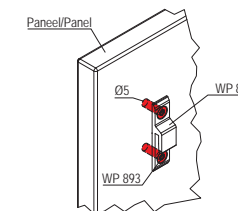
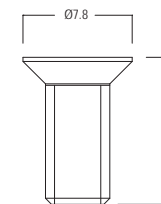

Slotted insert rail set

for hanging panels
L 1419 × W 30 × H 30 mm



WP 890-1500.01

aluminium/steel

1 × extrusion made of WP 890HZ with system grid 500 mm, for hanging panels on octawall pro frame with 1500 mm height, incl. 4 × fixing set M6 WP 895

L 1419 × W 30 × H 30 mm | 0.128 kg

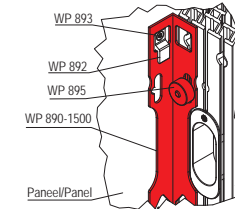
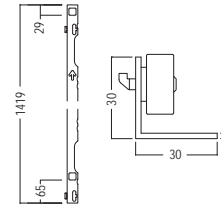

Slotted insert rail set

for hanging panels
L 919 × W 30 × H 30 mm



WP 890-1000.01

aluminium/steel

1 × extrusion made of WP 890HZ with system grid 500 mm, for hanging panels on octawall pro frame with 1000 mm height, incl. 3 × fixing set M6 WP 895

L 919 × W 30 × H 30 mm | 0.346 kg

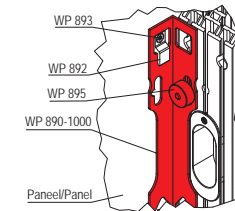
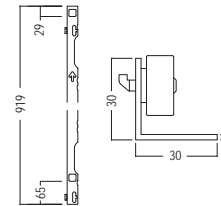

Slotted insert rail set

for hanging panels
L 419 × W 30 × H 30 mm



WP 890-500.01

aluminium/steel

1 × extrusion made of WP 890HZ with system grid 500 mm, for hanging panels on octawall pro frame with 500 mm height, incl. 2 × fixing set M6 WP 895

L 419 × W 30 × H 30 mm | 0.096 kg

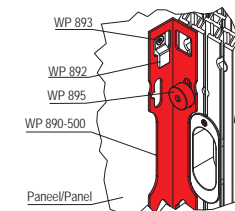
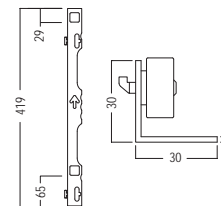

Slotted insert rail set

for hanging panels
L 399 x W 30 x H 30 mm



WP 890-480.01

aluminium/steel

1 x extrusion made of WP 890HZ with system grid 500 mm, for hanging panels on octawall pro frame with 480 mm height, incl. 2 x fixing set M6 WP 895

L 399 x W 30 x H 30 mm | 0.064 kg

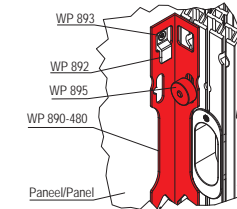
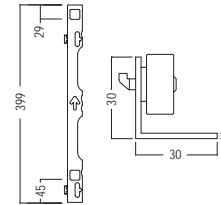

Slotted insert rail set

for hanging panels
top/bottom



WP 890-UO.01

aluminium/steel

1 x extrusion made of WP 890HZ with system grid, for hanging panels on octawall pro frame as top/bottom system punch, incl. 2 x fixing set M6 WP 895

L 236.5 x W 30 x H 30 mm | 0.064 kg

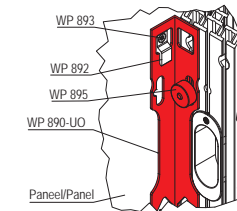
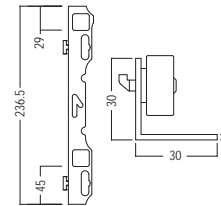

Electrical parts

octawall pro

Pendant light

1 illuminated side
L 1000 × W 80 × H 80 mm

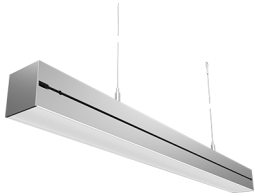

OL 3100.01 | .03

aluminium

Set consisting of: 1 × upright L 1022-1000B, 1 × power cable L 204, 1 × RGB remote control L 185-2, 2 × steel rope 1,5 × 3.500 mm OL 466, 2 × wire rope retainer set L 222

L 1000 × W 80 × H 80 mm | 4.106 kg

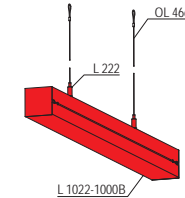
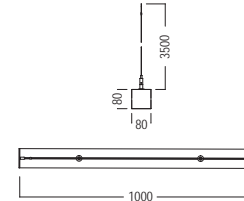

Pendant light

1 illuminated side
L 2000 × W 80 × H 80 mm

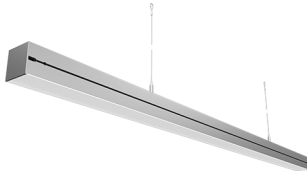

OL 3200.01 | .03

aluminium

Set consisting of: 1 × upright L 1022-2000B, 1 × power cable L 204, 1 × RGB remote control L 185-2, 2 × steel rope 1,5 × 3.500 mm OL 466, 2 × wire rope retainer set L 222

L 2000 × W 80 × H 80 mm | 6.933 kg

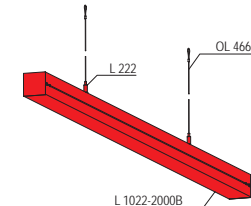
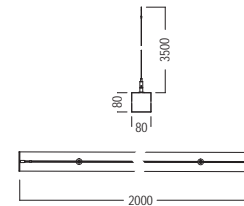

Pendant light

1 illuminated side
L 3000 × W 80 × H 80 mm



OL 3300.01 | .03

aluminium

Set consisting of: 1 × upright L 1022-3000B, 1 × power cable L 204, 1 × RGB remote control L 185-2, 2 × steel rope 1,5 × 3.500 mm OL 466, 2 × wire rope retainer set L 222

L 3000 × W 80 × H 80 mm | 9.882 kg

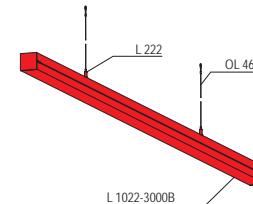
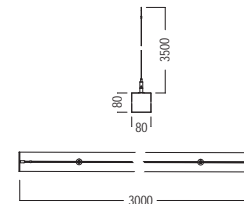

Electrical parts

octawall pro

Wallwasher

LED / 28W / 230V
L 812 x W 166 x H 263 mm



M 1497.31 | .33

aluminium

for uniform illumination of 1000 mm width and 2500 mm height (5700 Kelvin > Cri 90, 3600 lm, 28 W, 125 lm/W), for 230 V power source, for system groove 4.3 mm, space-saving and securely packed, with 16 high-power LEDs, PSU incl. cable (500 mm to lamp and 2500 mm from power supply)

L 812 x W 166 x H 263 mm | 2.041 kg

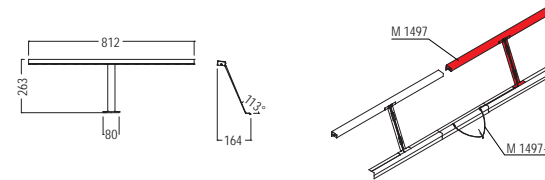

Hanging lamp

LED / 56W / 230V
L 818 x W 150 x H 35 mm



M 1497-H.33

aluminium, matt powder-coated

for a homogenous illumination in 5700K > Cri 90, with 32 highpower LEDs, 7200 lm, 56 W, 128 lm/W, for 230 V, incl. 3.5 m wire rope with 2 x Reutlinger wire rope holders to adjust height, 2 x plastic end caps black, 1 x power supply unit incl. DC distributor, 3 m extension cable with DC connector

L 818 x W 150 x H 35 mm | 2.49 kg

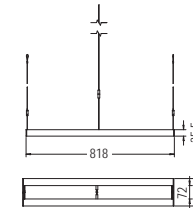

Power supply

for wallwasher M 1497
L 1175 x W 72 x H 35 mm

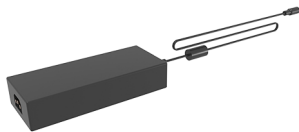

M 1497-11.90

plastic

for wallwasher M 1497, converter with 24V, 6.67A, 160W, rated voltage AC 100-240V, 50/60Hz, cable 1000 mm long

L 1175 x W 72 x H 35 mm | 0.638 kg

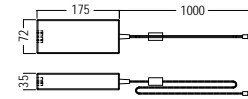

Attention: suitable power cord M 1497-12 is required

Electrical parts

octawall pro

Cable

for wallwasher M 1497
2500 mm long

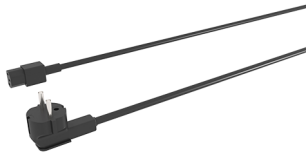

M 1497-12.90

plastic, black

for wallwasher M 1497, power cord CEE 7/7 - C13
2500 mm long | 0.259 kg

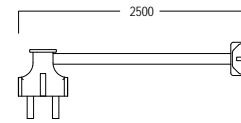

Extension cable

for wallwasher M 1497
3000 mm long



M 1497-1.33

plastic, black

cable for connecting M 1497 wallwashers, with angled barrel connector at both ends
3000 mm long | 0.128 kg

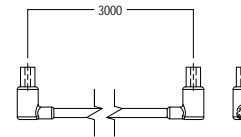

PWM Dimmer

for wallwasher M 1497
L 150 x W 40 x H 20 mm



M 1497-4.90

plastic

1 x control unit and remote control for dimming of max. 5
wallwasher M 1497, DC 12-24 V, 2.4 GHz, PWM frequency 1.95 KHz
L 150 x W 40 x H 20 mm | 0.103 kg

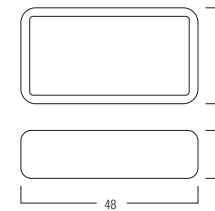

Electrical parts

octawall pro

Cable

Y-Splitter for wallwasher M 1497



M 1497-3.90

plastic, black

Y-cable for connecting up to 5 x wallwasher M 1497, with barrel connector at all ends

300 mm long | 0.041 kg

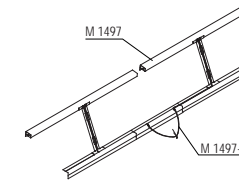
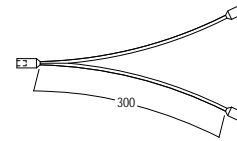

Long-arm floodlight

25 W L 490 x W 232 x H 40 mm



M 1494.31 | .33

aluminium

for swivel mounting in system groove, incl. adapter plate and connection cable 3 m, 25 W, 2500 lm, 4000 K, voltage input: 100-240 VAC, voltage output: 27-35 VDC, color rendering index: 80+ CRI, beam angle: 120°, up to 10 floodlights can be connected in series

L 490 x W 232 x H 40 mm | 0.76 kg

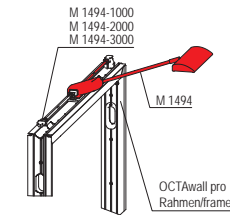
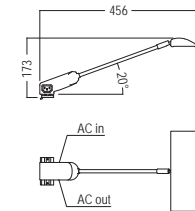

**without connecting
cable M 1494-xxxx**

Connecting cable

for M 1494 1000 mm long



M 1494-1000.33

rubber

230V connecting cable for IEC C13 connections, one side plug, one side socket, can also be used as an extension

1000 mm long | 0.115 kg

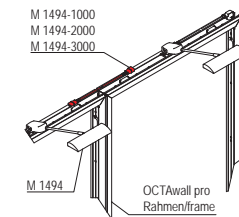
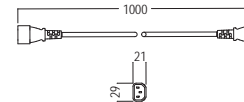

Electrical parts

octawall pro

Connecting cable

for M 1494
2000 mm long

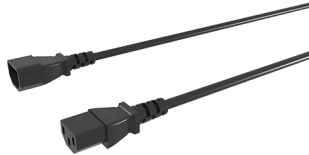

M 1494-2000.33

rubber

230V connecting cable for IEC C13 connections, one side plug, one side socket, can also be used as an extension

2000 mm long | 0.23 kg

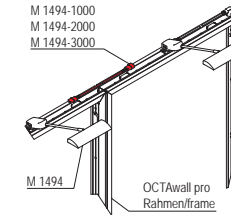
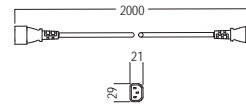

Connecting cable

for M 1494
3000 mm long

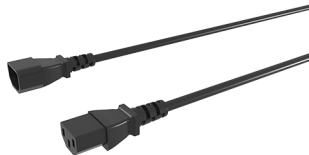

M 1494-3000.33

rubber

230V connecting cable for IEC C13 connections, one side plug, one side socket, can also be used as an extension

3000 mm long | 0.35 kg

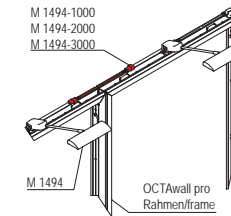
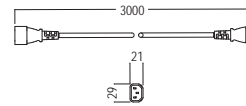

Cable protection

for cable outlet
for extrusion WP 860



WP 85-8.35

plastic

for extrusion WP 860, for cables with plug, to protect cables against damage during installation

L 90 × W 36 × H 34 mm | 0.009 kg

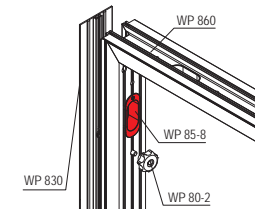
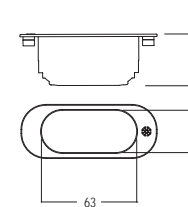

↗ Packaging/Transport

octawall pro

Pallet

for frames W 950 mm
L 2550 × W 1010 × H 125 mm



W 2020-P.90

wood

Packing, storing and transport, suitable for all octawall frames width 950 mm

L 2550 × W 1010 × H 125 mm | 31 kg

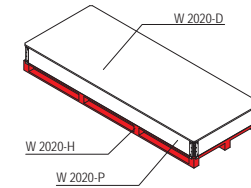
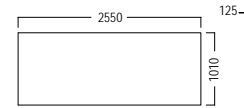

Stacking frame

for frames W 950 mm
L 2550 × W 1050 × H 200 mm



W 2020-H.90

wood/steel

Packing, storing and transport, suitable for all octawall frames width 950 mm

L 2550 × W 1050 × H 200 mm | 13.8 kg

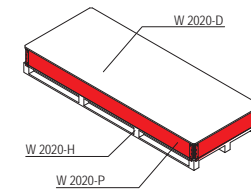
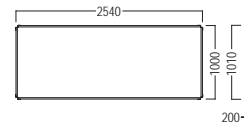

Stacking frame cover

for frames W 950 mm
L 2550 × W 1050 × H 15 mm



W 2020-D.90

wood

Packing, storing and transport, suitable for all octawall frames width 950 mm

L 2550 × W 1050 × H 15 mm | 14.5 kg

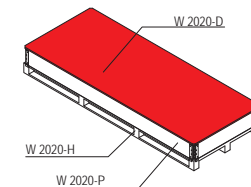
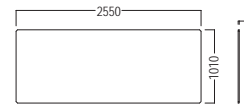

↑ Sets

octawall pro

Set

10 frames
L 2550 × W 1010 × H 1140 mm



WP-SET 1.01

aluminium

Set consisting of: 10 × frame WP 860-11, 2 × corner upright WP 850-248, 4 × cover extrusion WP 830-248, 45 × quick connector kit frame WP 80-1, 25 × quick connector kit upright WP 80-2, 20 × adjustable foot WP 80-3, 1 × pallet W 2020-P, 1 × cover W 2020-D and 5 × stacking frame W 2020-H

L 2550 × W 1010 × H 1140 mm | 278.01 kg

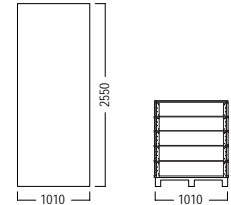

1 fabric size = outer frame dimension

Set

11 frames
with door



WP-SET 2.01

aluminium

Set consisting of: 11 × frame WP 860-11, 4 × corner upright WP 850-248, 9 × cover extrusion WP 830-248, 40 × quick connector kit frame WP 80-1, 45 × quick connector kit upright WP 80-2, 22 × adjustable foot WP 80-3, 1 × door element W 805-SET, 1 × pallet W 2020-P, 1 × cover W 2020-D and 6 × stacking frame W 2020-H

L 2550 × W 1010 × H 1340 mm | 345.55 kg

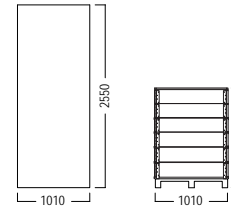

1 fabric size = outer frame dimension

➤ technical information

➤ TI-ES-662	45
octawall pro panel dimensions for slotted insert rail WP 890	
➤ TI-M-71.0	46
Fabric size door leaf frame for W 575/ W 425/ W 415 including W 414	
➤ TI-MBOW-A00	47
Door W 805 Installation Instructions for Door Leaf	
➤ TI-MBOW-A01	48
Door W 805 Mounting Variants	
➤ TI-MBOW-A02	49
Door W 805 Pannel and Fabric Dimensions	
➤ TI-MBOW-A03	50
Door W 805 Window Element W 809 Pannel and Fabric Dimensions	
➤ TI-MBOW-T300A	51
W 575 door element fabric around M 1020	
➤ TI-MBOW-T912A	52
octawall pro WP 85-8 Position Cable Outlet	
➤ TI-MBOW-T932A	53
octawall pro W 575 Door Installation in Corner	
➤ TI-MBOW-T933A	54
octawall pro W 575 Door Installation in Wall	
➤ TI-MBOW-T940	55
octawall pro WP 860-C frame element curved, 515 mm fabric + panel	

➤ technical information

➤ TI-MBOW-T941	56
octawall pro WP 860-C frame element curved, 515 mm panel	
➤ TI-MBOW-T948A	57
octawall pro WP 810/WP 860 Loop Tape Requirement	
➤ TI-MBOW-T952A	58
octawall pro Mounting of LED Module	
➤ TI-MBOW-T955A	61
octawall pro WP 800/WP 850/WP 840 Fabric Dimensions Corner Uprights	
➤ TI-MBOW-T963A	62
octawall pro WP 820 T-Connection Extrusion Fabric Dimensions	
➤ TI-MBOW-T971A	63
octawall pro Quick Connectors WP 80-1 and WP 80-2 / WP 80-23	
➤ TI-MBOW-W 420A0	64
octawall 40 Fabric and Panel Dimensions, Sliding Door W 420	
➤ TI-MBOW-W 420A1	65
octawall 40, Sliding Door W 420 with octawall 40 or octawall pro	
➤ TI-MBOW-W 420A2	66
octawall 40, Sliding Door Element W 420, 950 x 2500 mm	
➤ TI-MBOW-W 420A2HL	67
octawall 40, Sliding Door Element W 420, 950 x 2500 mm	
➤ TI-MBOW-W 420A2HR	68
octawall 40, Sliding Door Element W 420, 950 x 2500 mm	

➤ technical information

➤ TI-MBOW-W 420A2VL	69
octawall 40, Sliding Door Element W 420, 950 x 2500 mm	
➤ TI-MBOW-W 420A2VR	70
octawall 40, Sliding Door Element W 420, 950 x 2500 mm	
➤ TI-MBOW-W 420A4	71
octawall 40, Sliding Door Element W 420, 950 x 2500 mm	
➤ TI-MBOW-W 420A5	72
octawall 40, Sliding Door Element W 420, 950 x 2500 mm	
➤ TI-OW-3.3	73
W 840 / W 841 Hook and loo tape notes	
➤ TI-WP-A01	74
octawall pro base plate WP 2450 (mounting possibilities)	
➤ TI-WW-1.0	75
M1497 Wallwasher Technical Data	
➤ TI-WW-2.0	76
M1497 Installation in the system groove	
➤ TI-WW-2.1	79
M1497 Wiring of up to 5 wallwashers	
➤ TI-WW-3.0	80
M 1497-H Wallwasher Hanging Lamp	
➤ TI-WW-4.0	84
M 1497 Wallwasher data sheet and assembly	

➤ TI-WW-4.1

M 1497-4 Dimmer Wallwasher User Manual

89

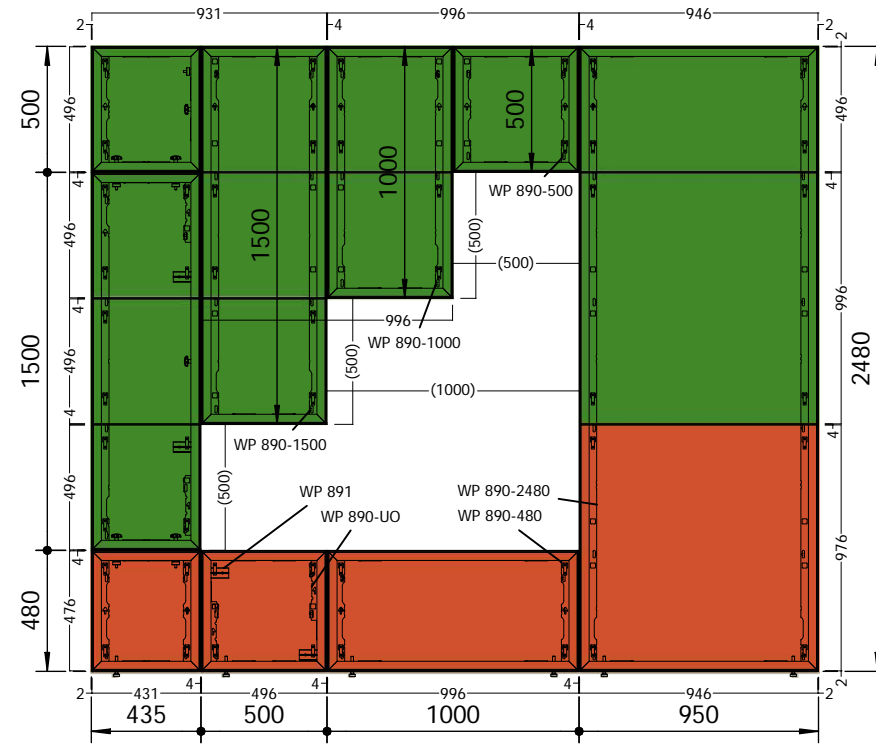
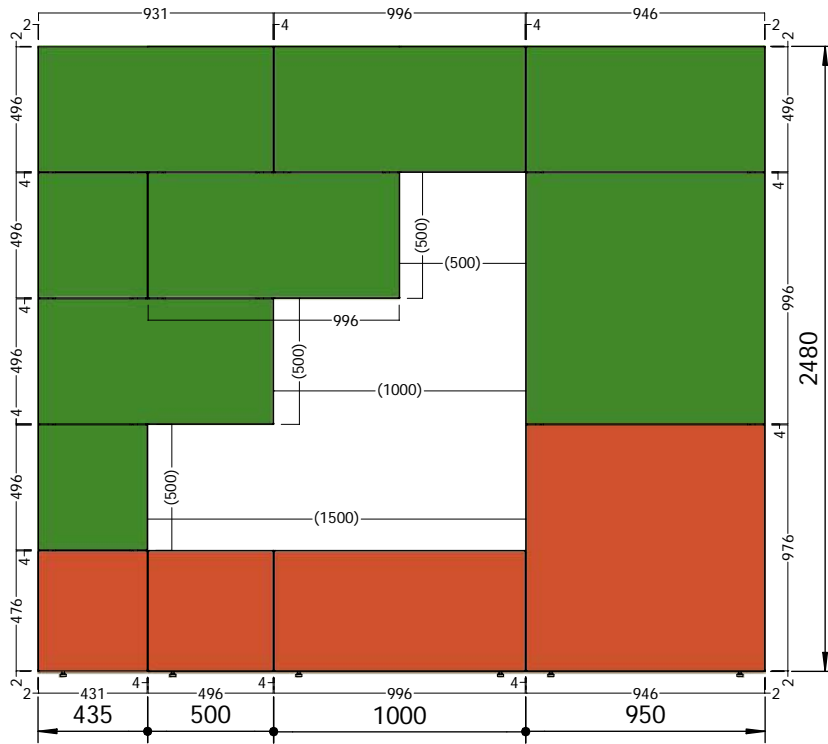

Typ A

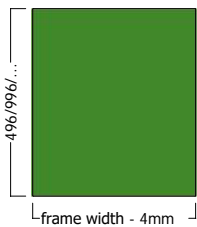

Typ A

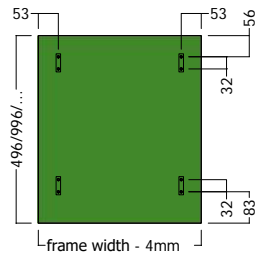

Typ B

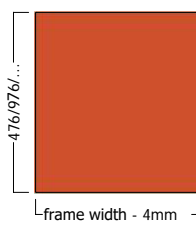

Typ B

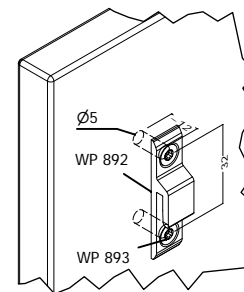
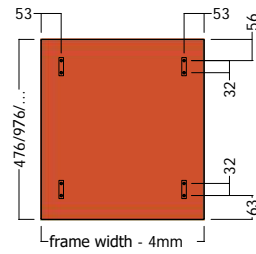

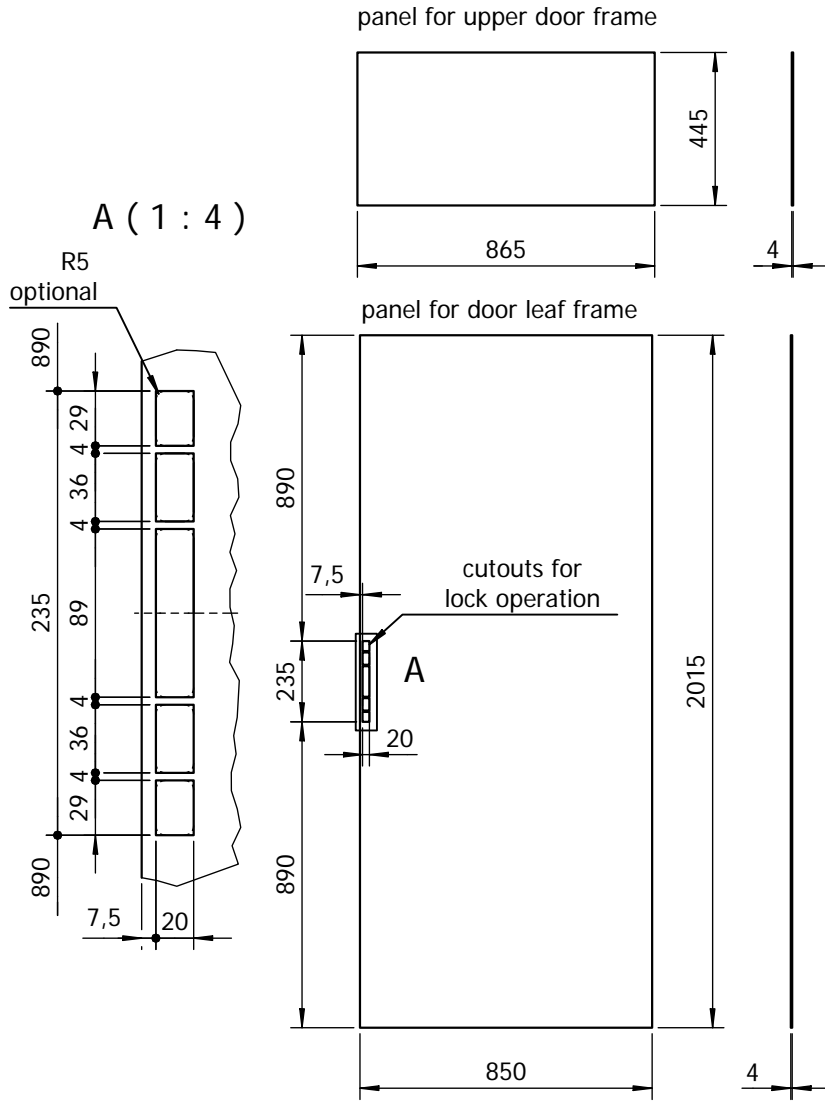

Fabric dimensions
 Outer dimensions door leaf frame: 2021 x 855
(ATTENTION: Use flat silicone welt 12x3mm for door leaf frame!)
 Outer dimensions upper door frame: 450 x 870

Panel dimensions
 Outer dimensions door leaf frame: 2015 x 850
 (see drawing)
 Outer dimensions upper door frame: 445 x 865

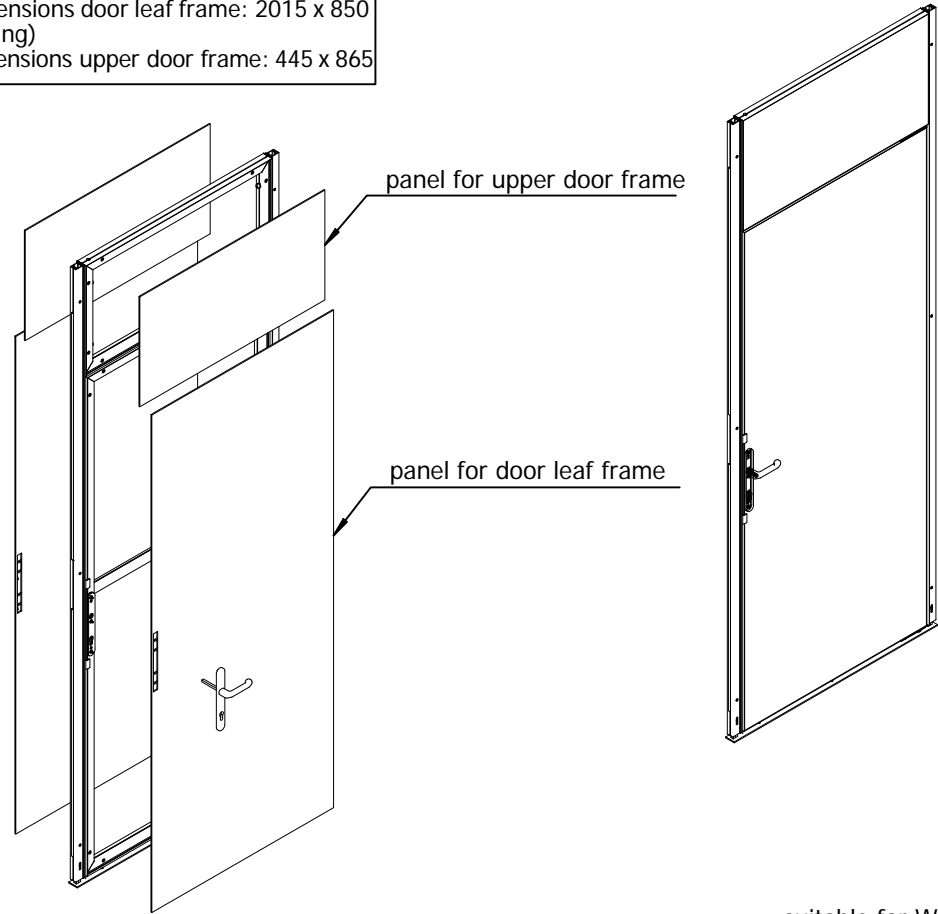

suitable for W 575

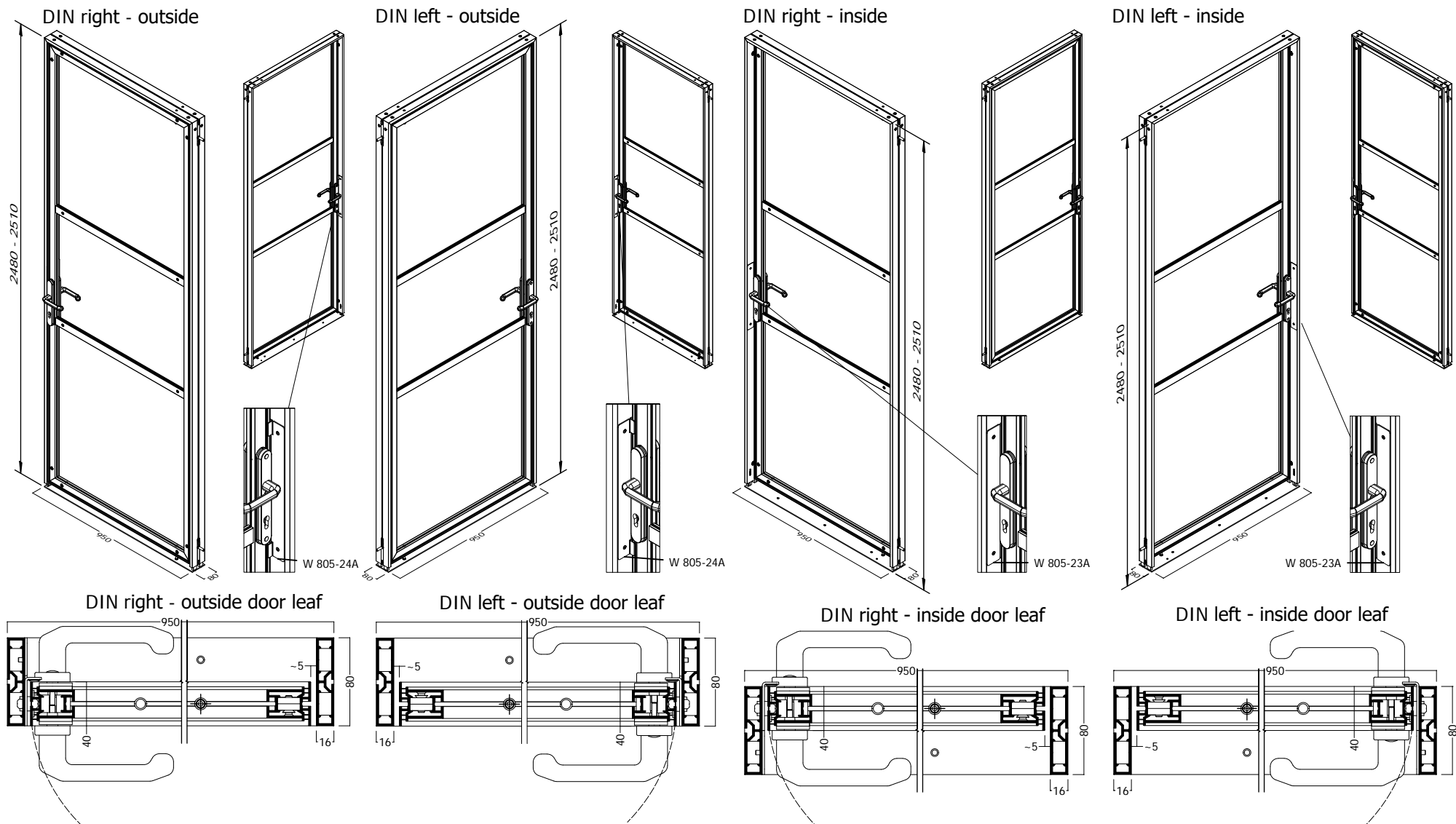

TI-MBOW-A00 E-000643-1300A-T00 A.1 Freigegeben 14.11.2024 ED

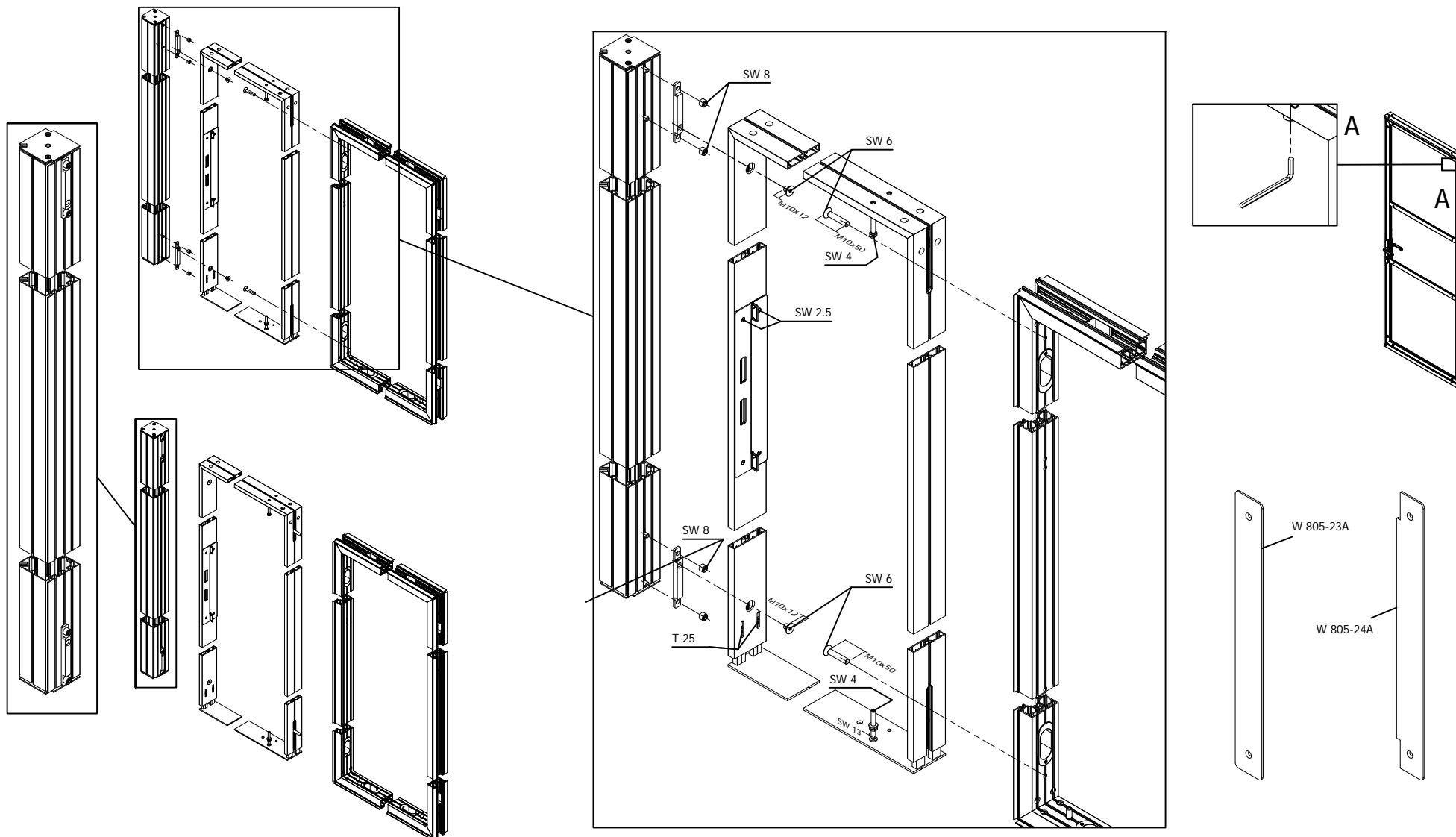

Fabric dimensions
 Outside dimensions of door frame: 2442 x 908
(ATTENTION: Use 12x3mm silicone edge for door frames!)

Panel dimensions
 Outside dimensions of door frame: 2036+0,5 x 903
 (see drawing)

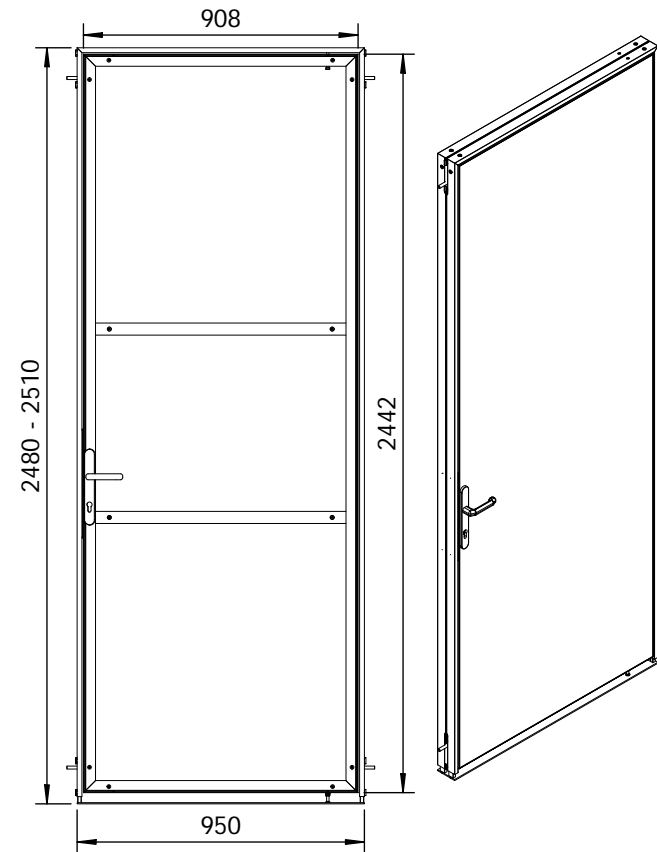
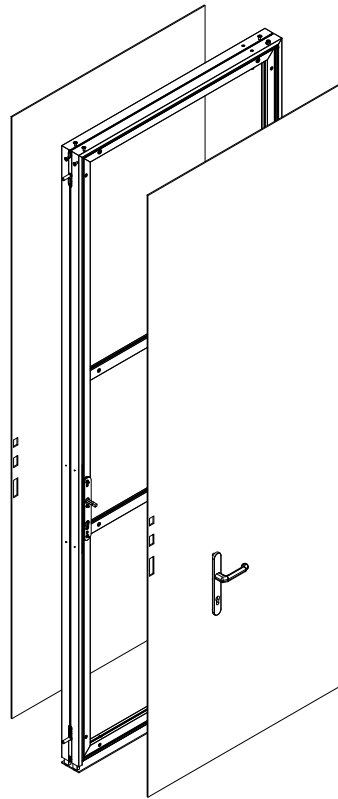
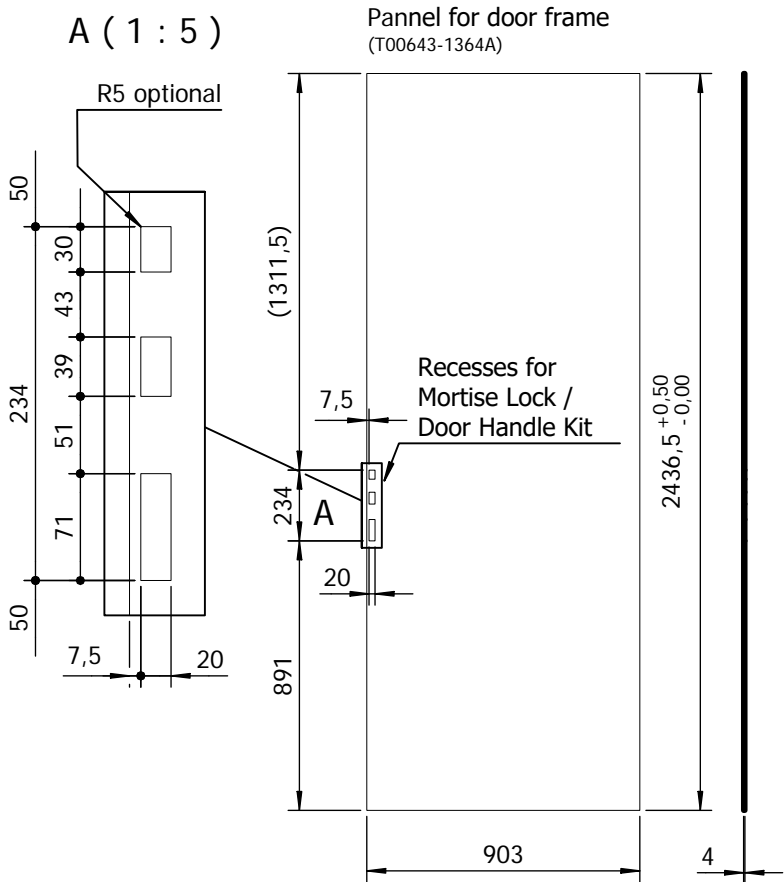

suitable for W 805

TI-MBOW-A02 E-000643-1300A-T02 A.1 Freigegeben 14.11.2024 ED

Fabric dimensions
 Outside dimensions of door frame: 2442 x 908
 (ATTENTION: Use 12x3mm silicone edge for door frames!)

Pannel dimensions
 Outside dimensions of door frame: 2436+0,5 x 903
 (see drawing)

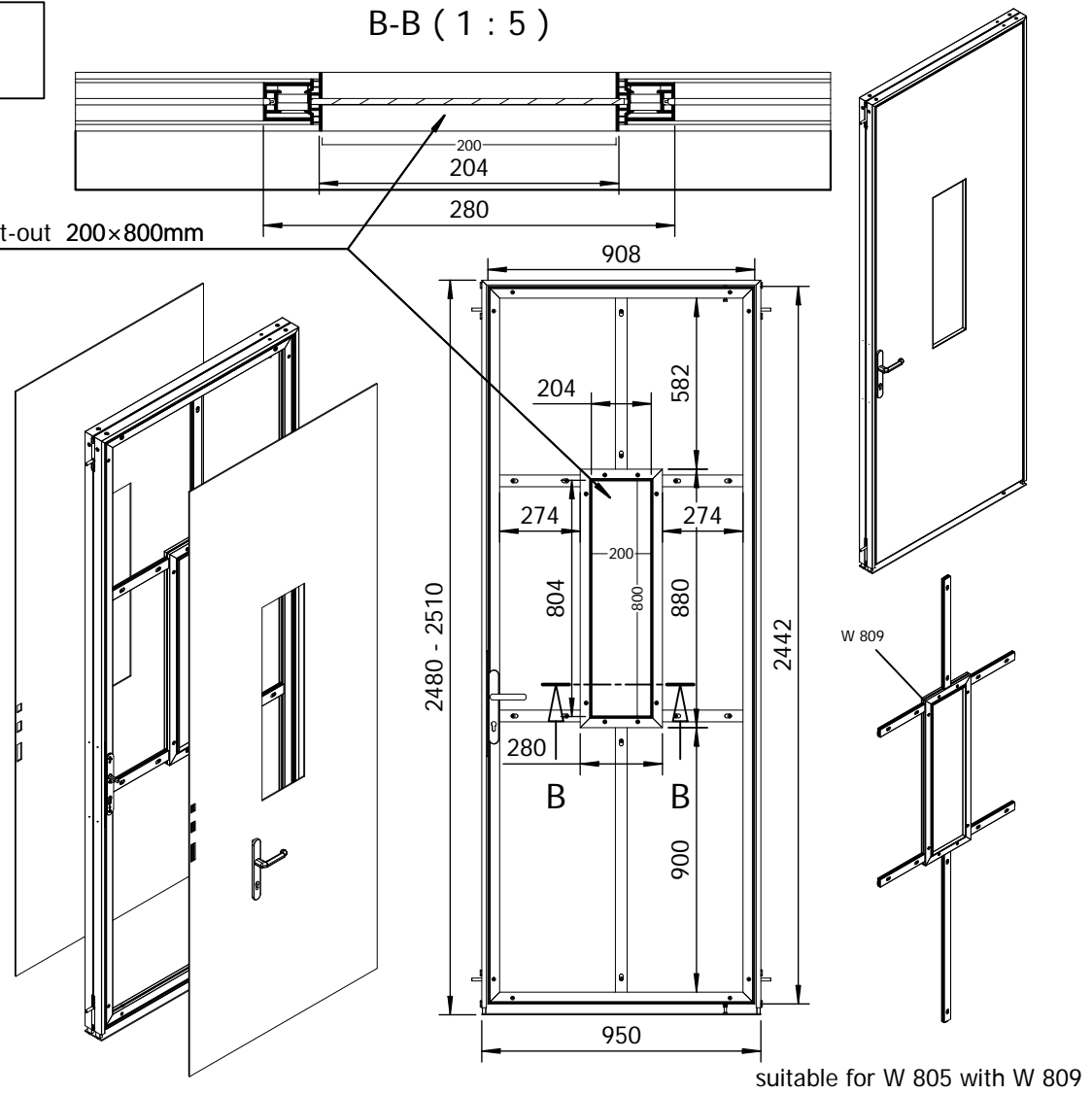
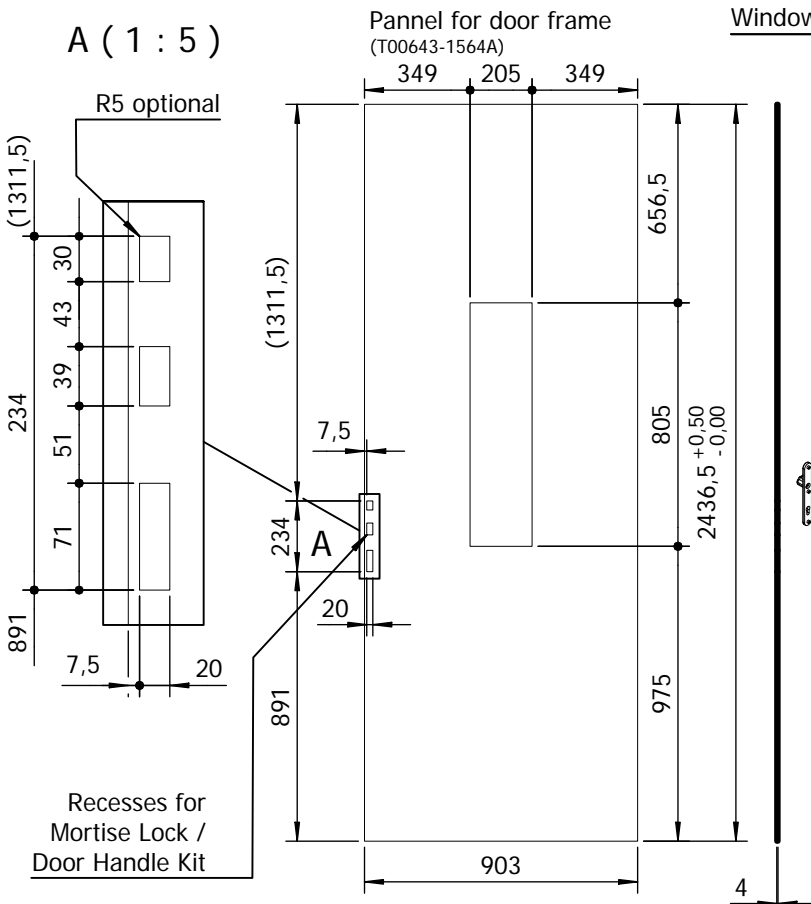

TI-MBOW-A03 E-000643-1500A-T00 A.1 Freigegeben 14.11.2024 ED

A (1 : 2.5) detail

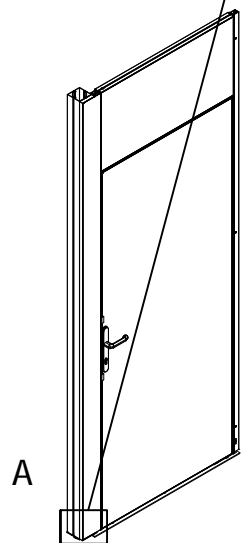
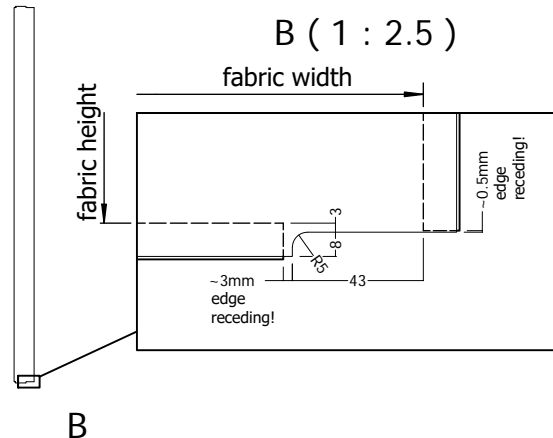
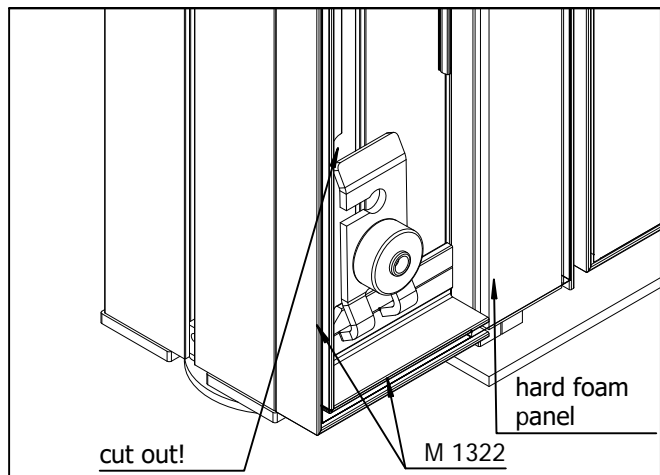

INFORMATION on fabric
extended fabric over upright M 1020

fabric width: = frame width (40 mm + 80 mm)

fabric height: = frame height/upright height

(Make sure to cut out corners!)

IMPORTANT:
We recommend to use only elastic fabrics and test them in advance
with the frames!

All dimensions in mm!
The drawing with dimensions remains basically valid!

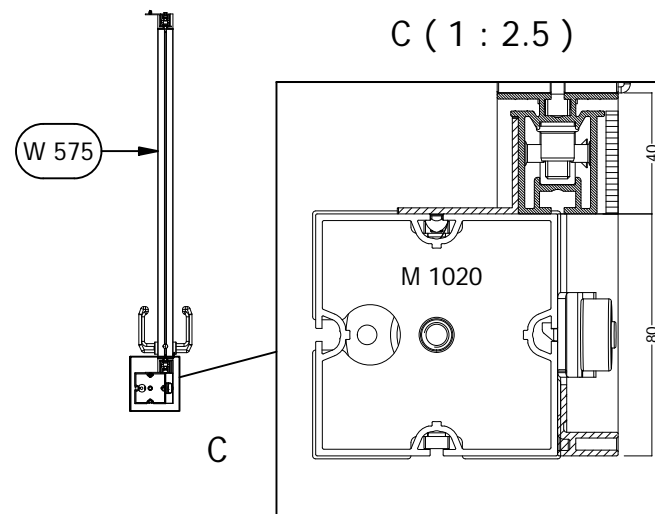

suitable for W 575

All dimensions
in mm!

Position of Cable Outlet in Frame

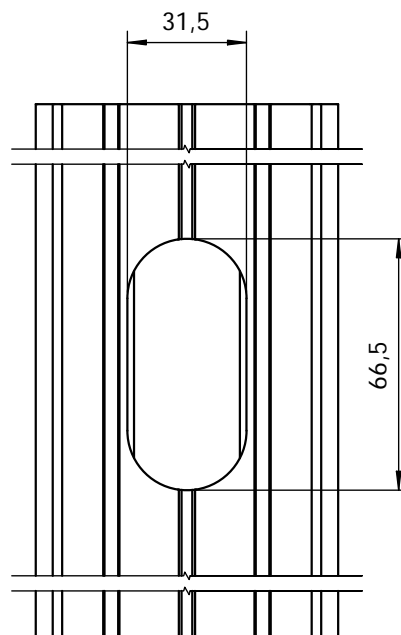
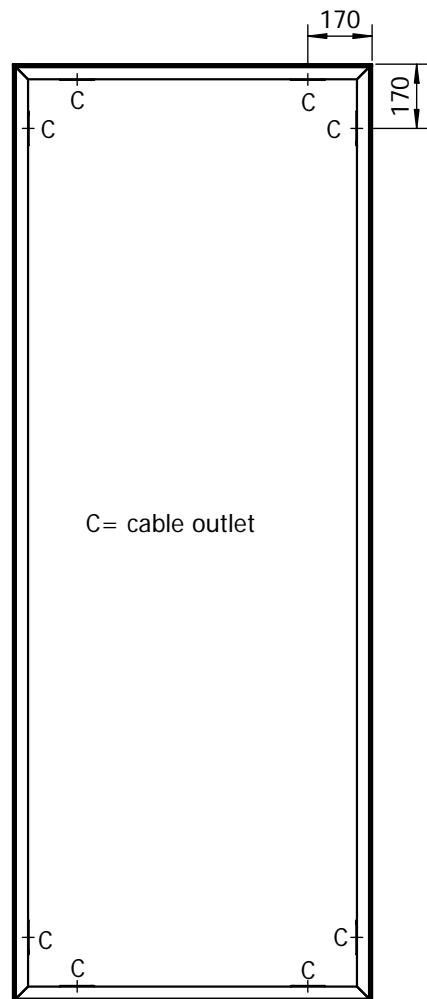

octawall pro cable outlet and cable protection

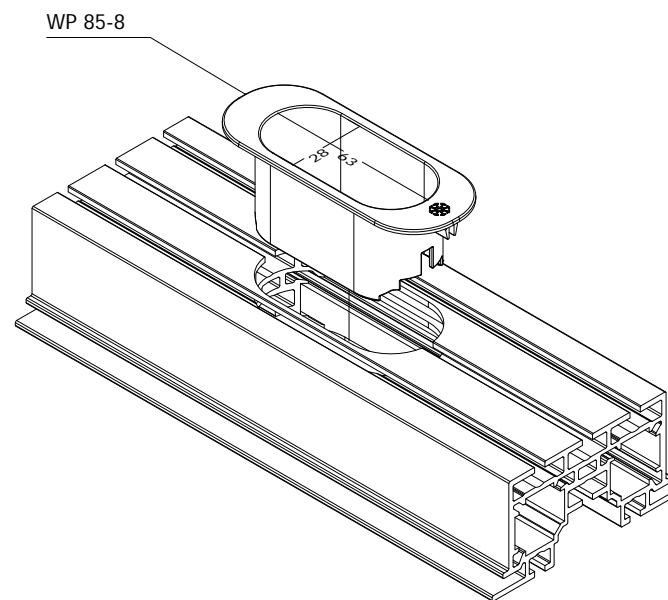

All dimensions in mm!
The drawing with dimensions basically remains valid!

Installation of Door W 575 with Door Mounting Set W 575-080

W 575 can be mounted DIN right and left.

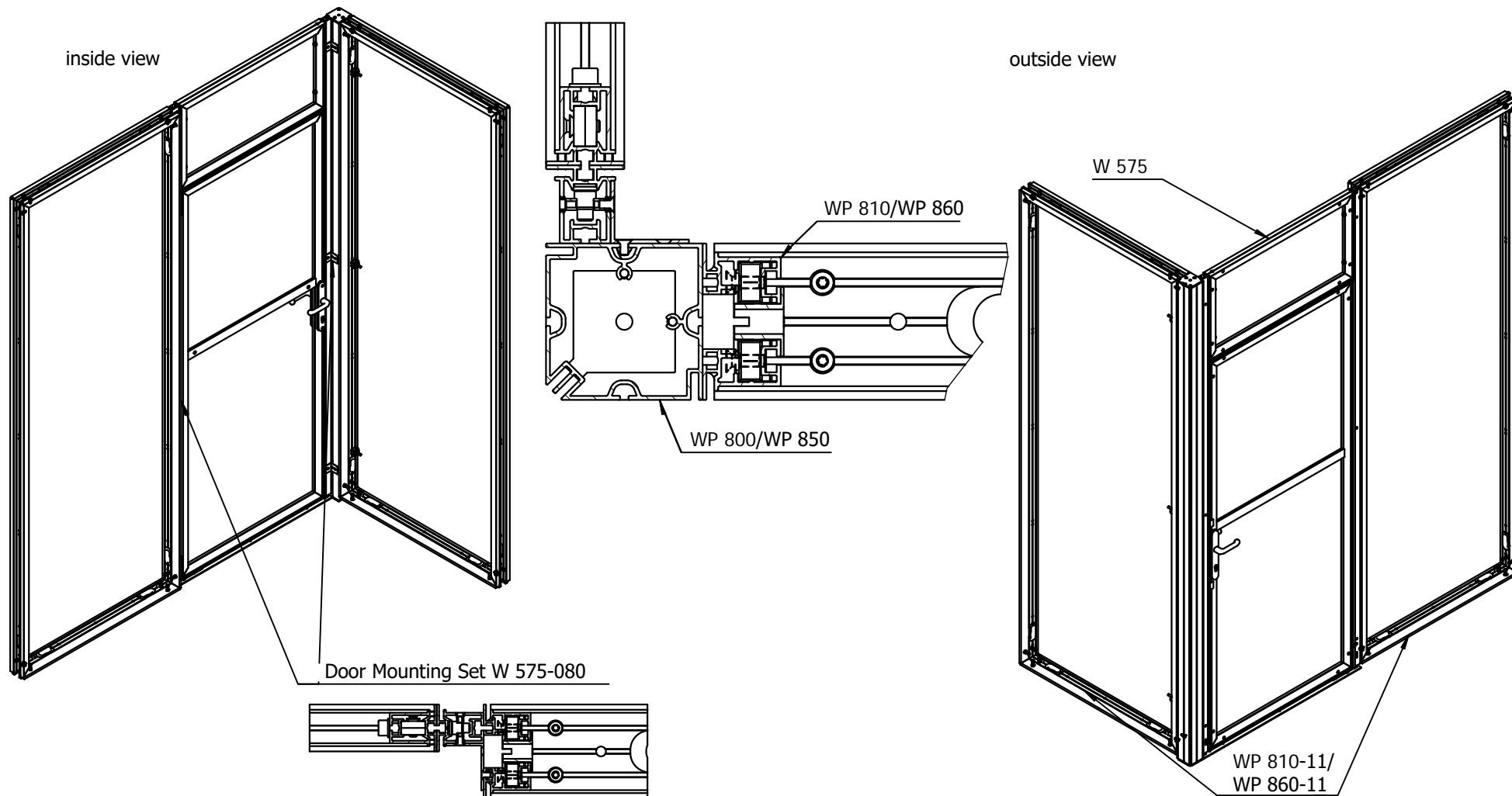

Installation of door W 575 with Door Mounting Sets W 575-080 is to be planned with adjustable feet in octawall pro frames WP 80-3.

All dimensions in mm!
The drawing with dimensions basically remains valid!

Installation of Door W 575 with Door Mounting Set W 575-080

W 575 can be mounted DIN right and left.

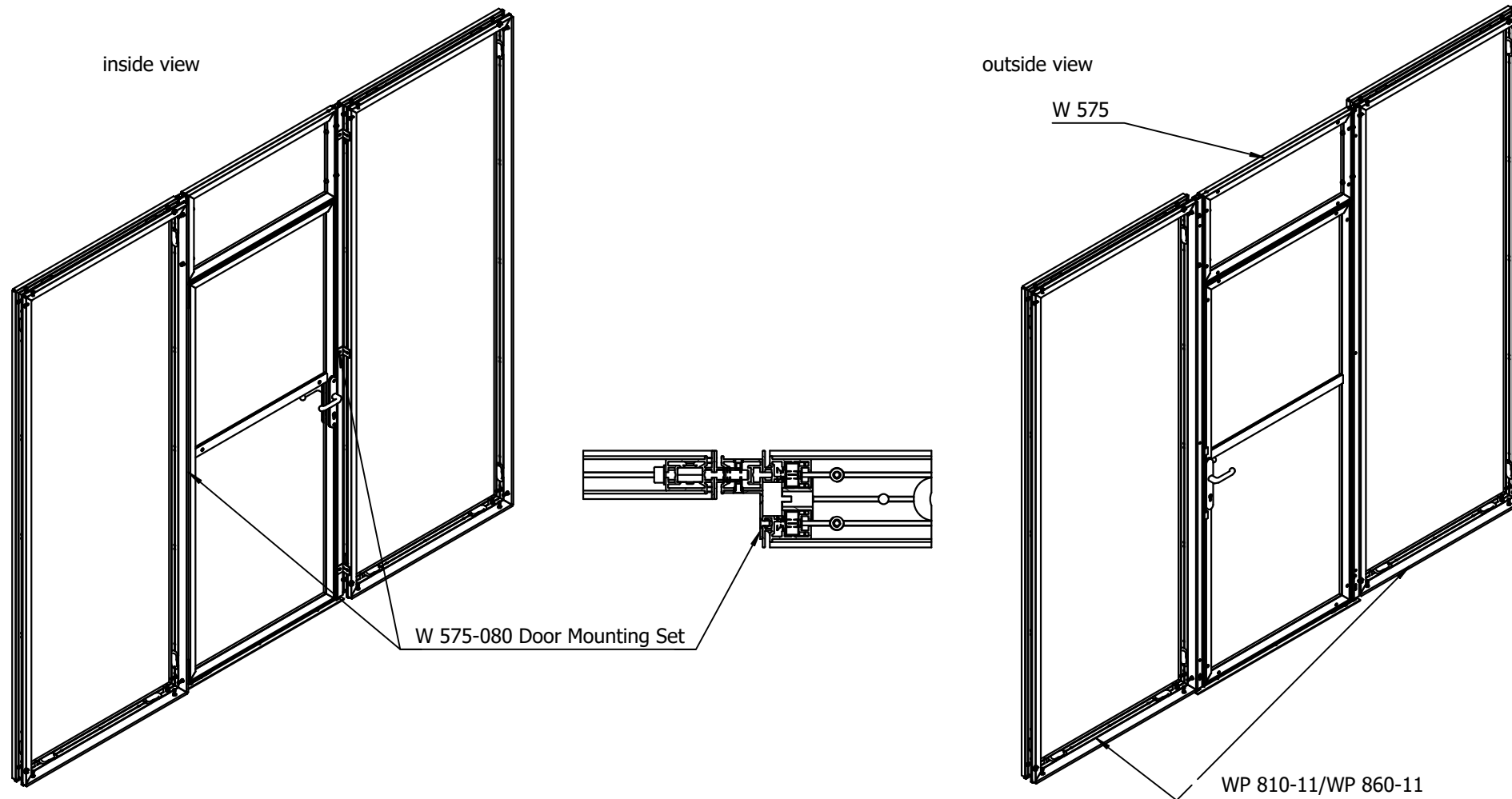

Installation of door W 575 with Door Mounting Set W 575-080 is to be planned with adjustable feet WP 80-3 in octawall pro frames.

All dimensions in mm!
The drawing with dimensions basically remains valid!

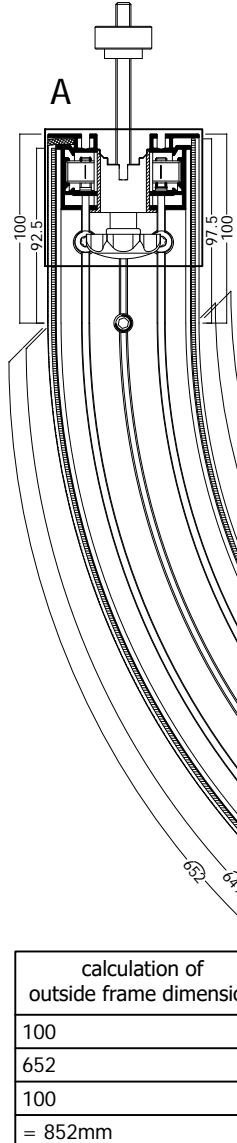

Fabric/Panel Dimension WP 860-C...

Outside fabric width: outside frame dimension = **852 mm**
 Outside fabric height: frame height = ____ mm

In the interior of the curved frame element, the fabric must be laminated onto the panel.

Outside panel width: outside frame dimension - 18 mm = **834 mm**
 Outside panel height: frame height - 15 mm = ____ mm

Inside panel width: inside frame dimension - 1 mm = **724 mm**
 Inside panel height: frame height - 5 mm = ____ mm
 (possibly covered with fabric)

Panel thickness: recommended **2 mm** (max. 3 mm)

frame height
2480mm
1500mm
1000mm
500mm
480mm

calculation of inside frame dimension
100
526
100
= 726mm

calculation of outside frame dimension
100
652
100
= 852mm

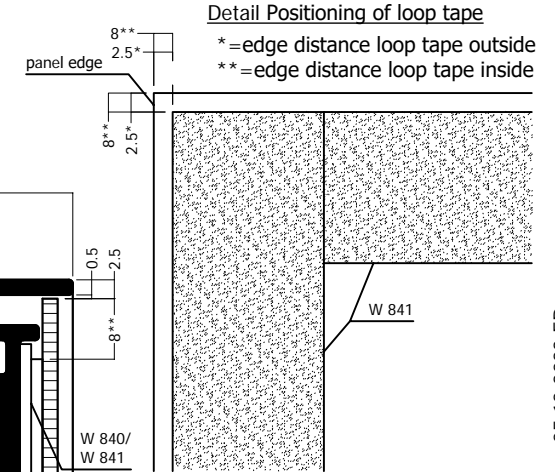
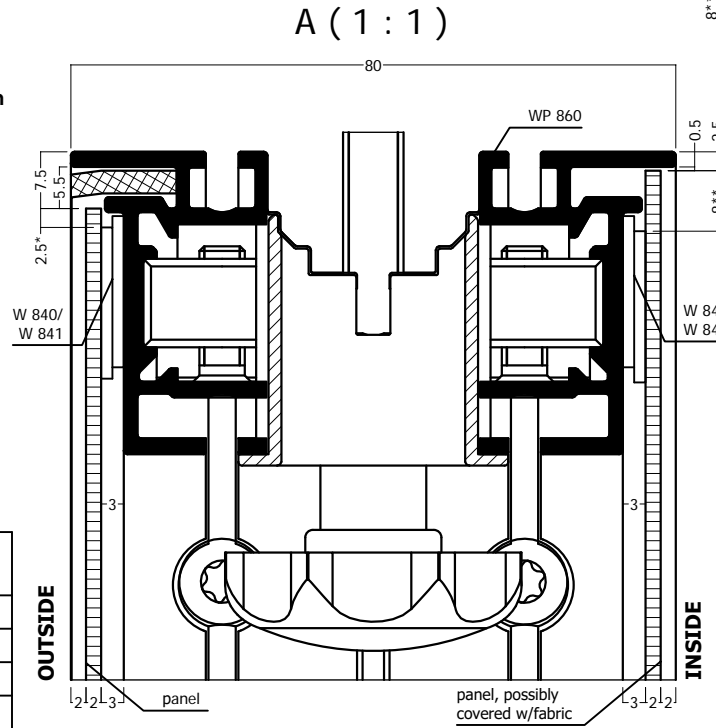

Backside view of panel

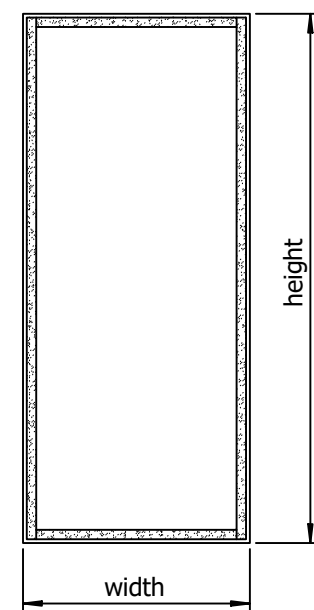

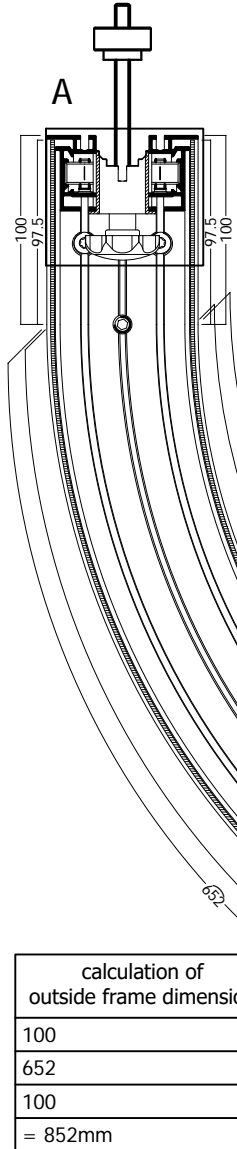

Panel dimension for WP 860-C...

Outside panel width: outside frame dimension - 8 mm = **844 mm**
 Outside panel width: outside frame dimension - 5 mm = ____ mm

Inside panel width: inside frame dimension - 2 mm = **724 mm**
 Inside panel height: frame height - 5 mm = ____ mm

Panel thickness: recommended **2 mm** (max. 3 mm)

frame height
2480mm
1500mm
1000mm
500mm
480mm

calculation of inside frame dimension
100
526
100
= 726mm

calculation of outside frame dimension
100
652
100
= 852mm

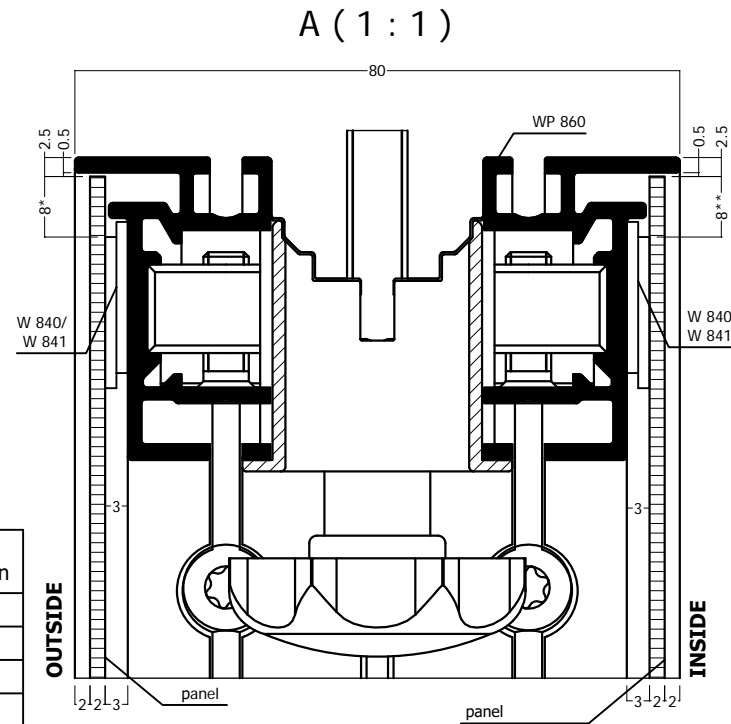

Detail Positioning of loop tape
 ** = edge distance loop tape

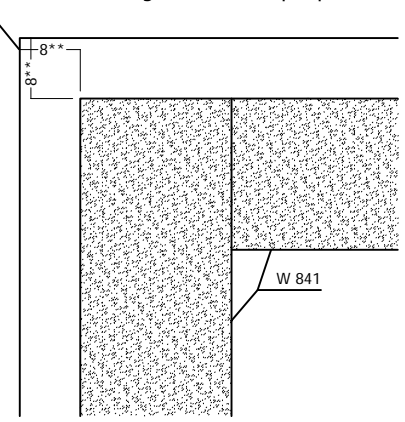

Backside view of panel

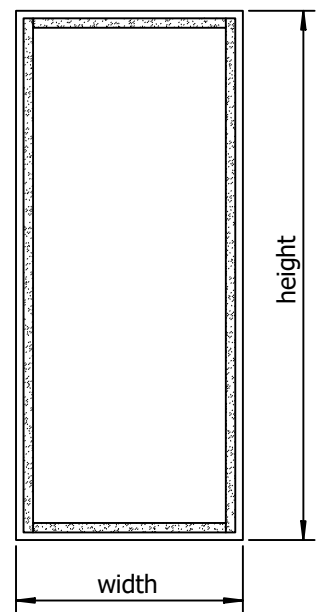

TIMBOWT941 E-000641-0692T-941 A Freigegeben 05.12.2023 ED

Loop Tape Requirements

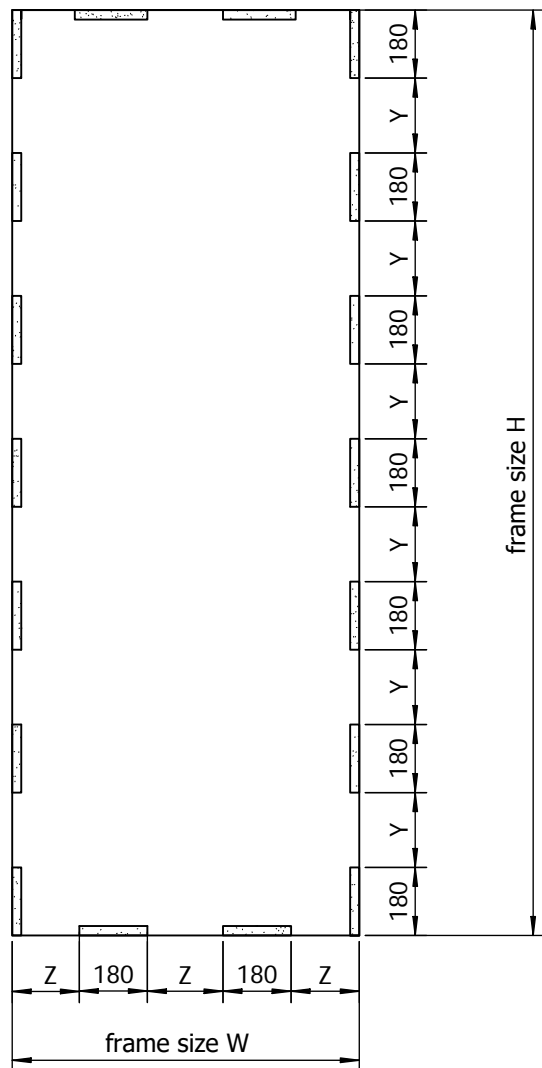

Panel Size

octawall pro panel

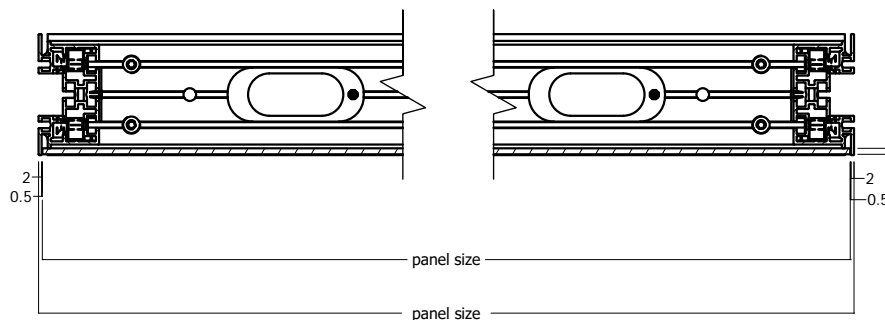

Width: frame size - 5 mm (1 mm gap calculated)
 Height: frame size - 6 mm (2 mm gap calculated)

eg. Loop Tape Requirements (mm)		
	H: 500	H: 950
W: 500	1440	2160
W: 1000	2160	2880
W: 1500	2880	3600

* The lengths indicated for the loop tape are also valid for similar frame sizes.

Loop tape requirements are calculated for a double-sided fitting of the frame with panels.

All dimensions in mm!
 The drawing with dimensions basically remains valid!

To be observed when mounting LED Modules

1. Due to the weight of the modules, the frames must be equipped with feet so that they can be perfectly leveled.
2. Use frames WP 810-1 - WP 810-6 / WP 860-1 - WP 860-6 to install LED modules to comply with their width of 500 mm.
3. The LED modules must be enclosed by frames. The frames must each be secured to the next frame with 2 WP 80-1 quick connectors. If this is not possible through the connecting holes in the frame, the M10 threaded hole for foot mounting can be used as well.

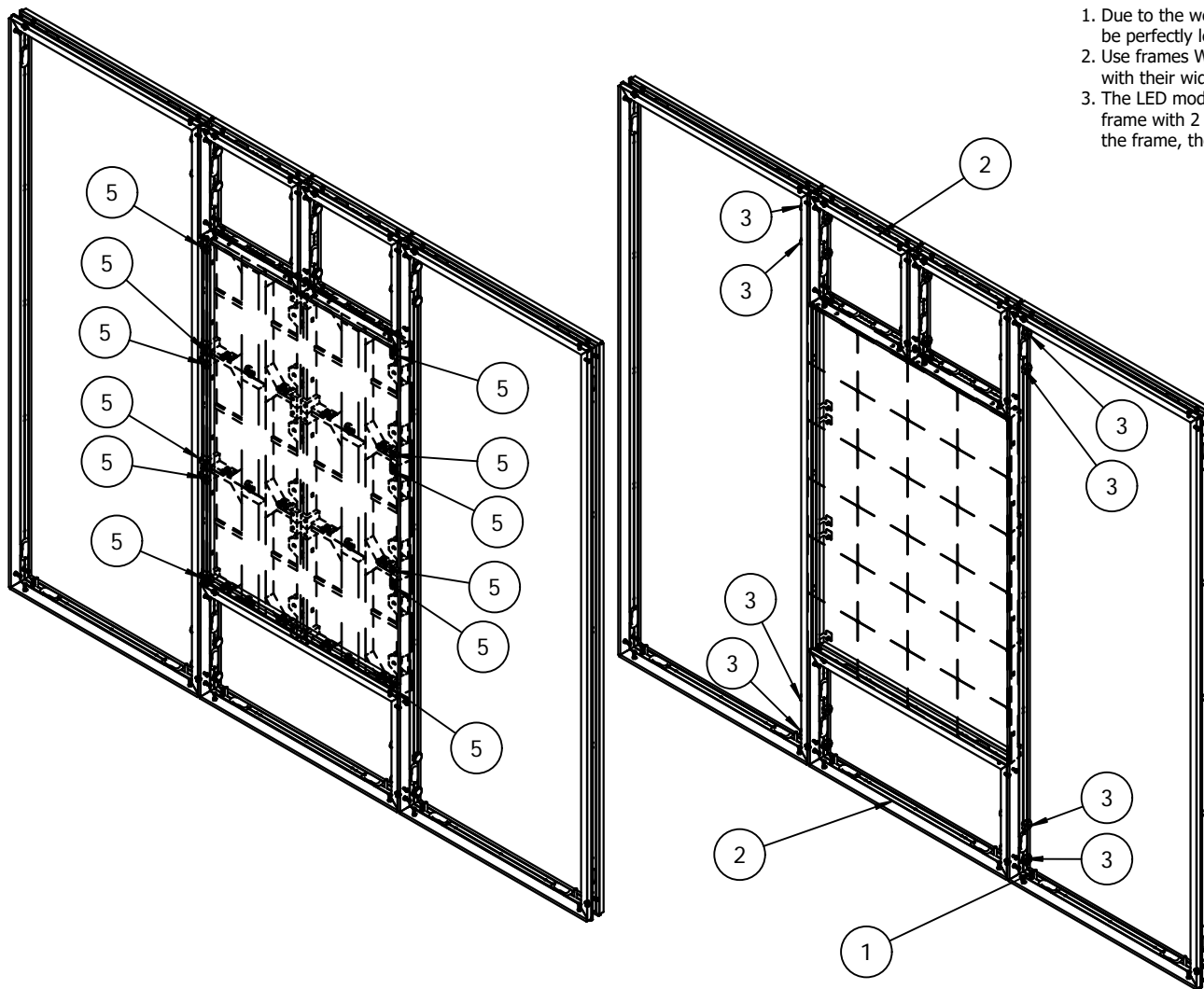

All dimensions in mm!
The drawing with dimensions basically remains valid!

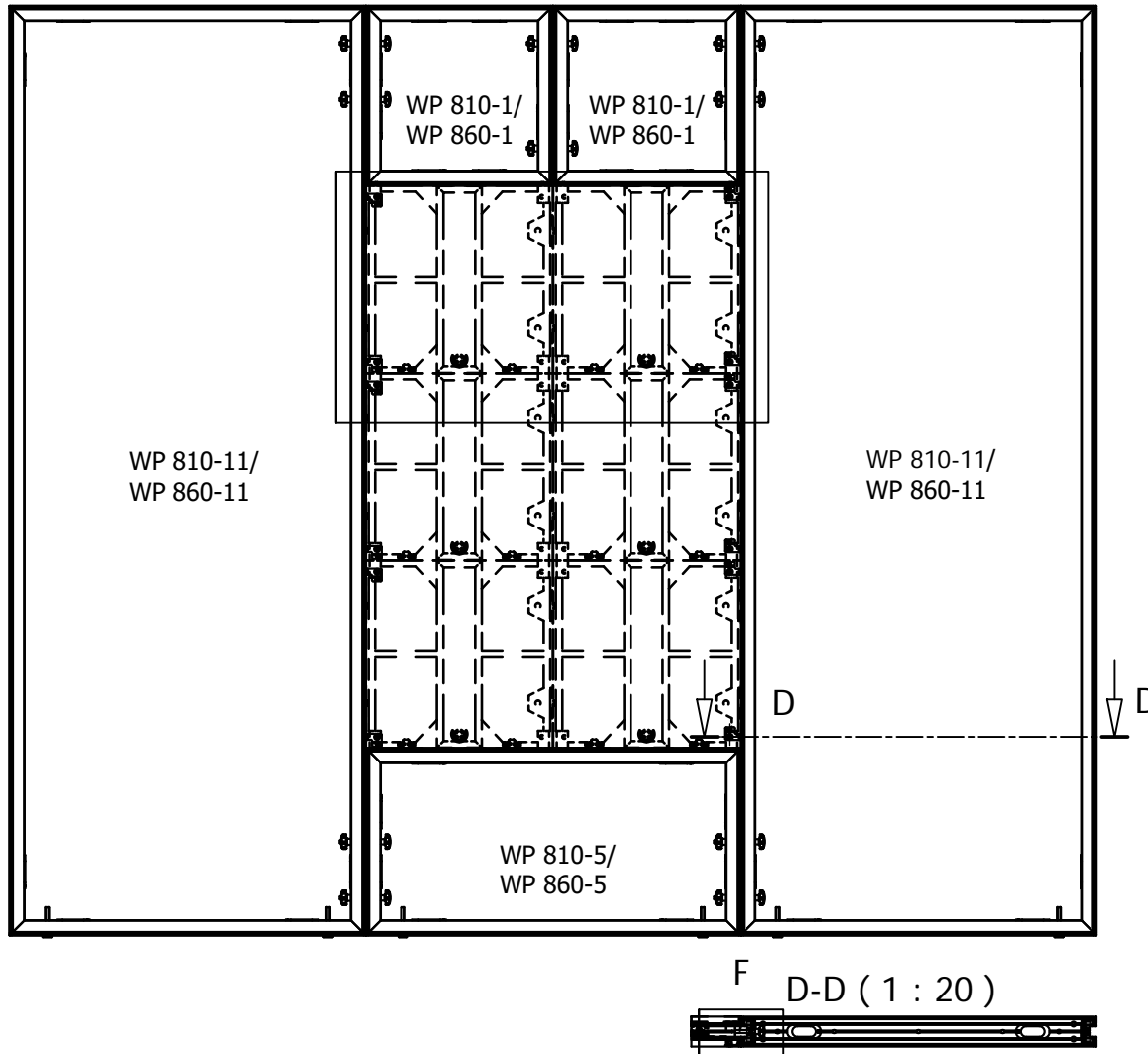

4. The LED modules of the top and bottom row must first be prepared for installation by unscrewing the locking pins

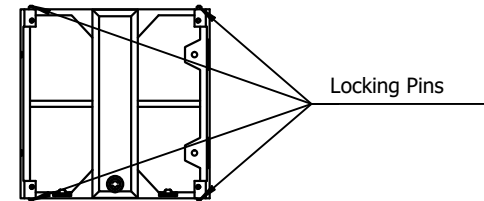

5. The LED modules tested by octanorm for octawall pro frames are installed with LED panel hooks WP 80-5 - WP 80-7. These LED panel hooks are attached to the vertical outer edges of the LED array in each M10 fixing hole of the LED modules. The LED panel hooks are inserted into the groove of the extrusion.

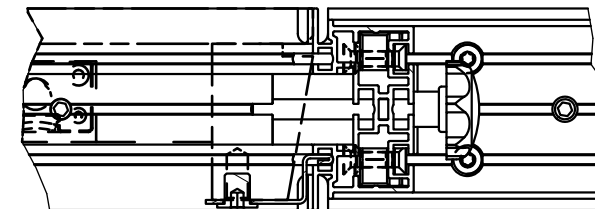
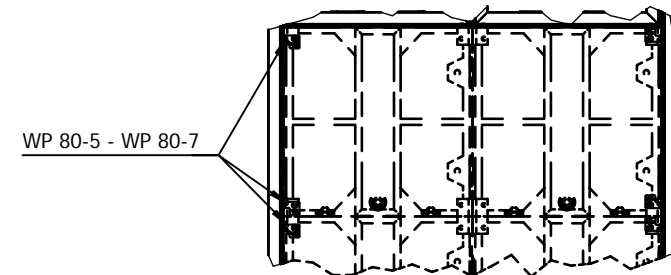

6. When wiring the modules, make sure that the cables do not protrude beyond the back of the frame system. The connections of the LED module unit must be routed through the cable protection WP 80-8. For the connection to the frame extrusion, the panel hooks are inserted into the groove of the extrusion.

All dimensions in mm!
The drawing with dimensions basically remains valid!

Front

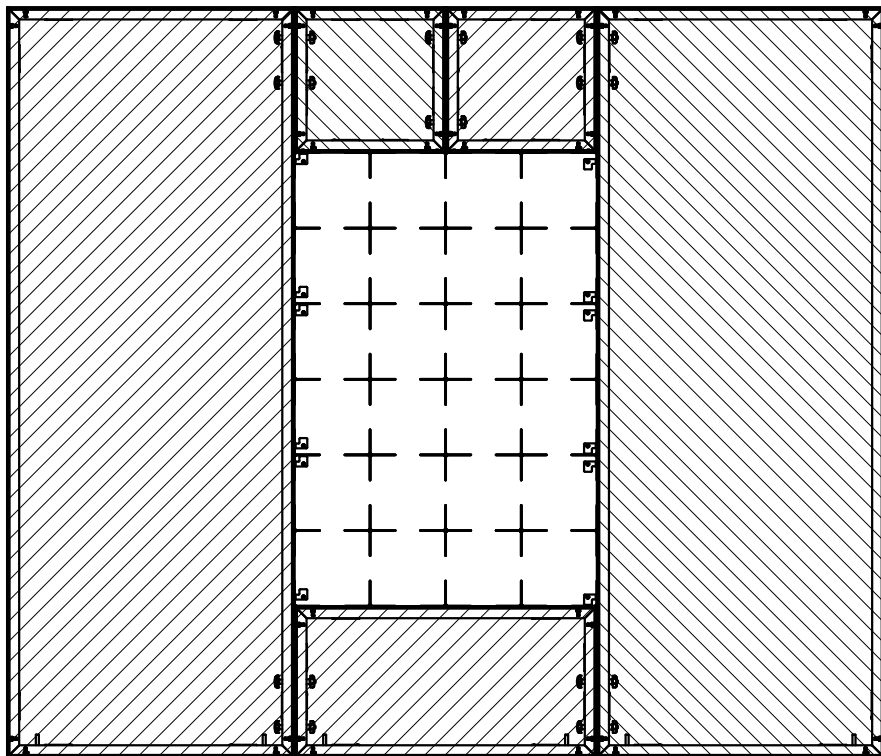

Back

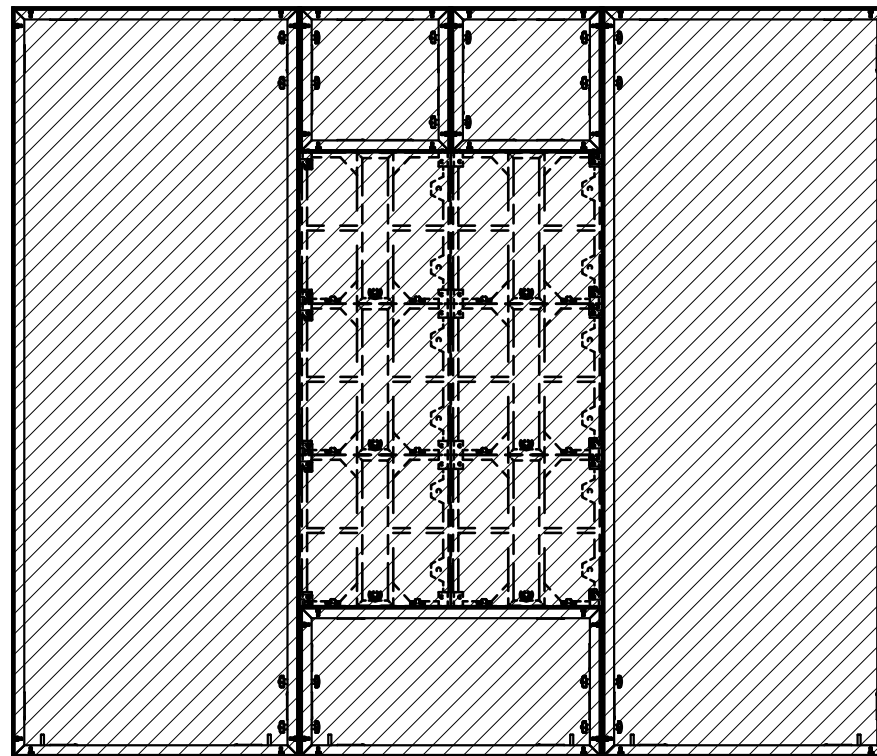

Fabric covering with LED module installation

The front can be covered with fabric frame by frame or clad with panels.

If the back is to be covered with fabric, a frame on each side of the LED module assembly must be included. This is the only way to cover the back of the LED module assembly.

All dimensions in mm!
The drawing with dimensions basically remains valid!

vertical fabric dim. = outside frame height horizontal fabric dim. = outside frame width + upright cover dim. (see drawing).

At the 90° and 135° uprights, the silicone edge is to be cut out horizontally so that it does not to overlap.

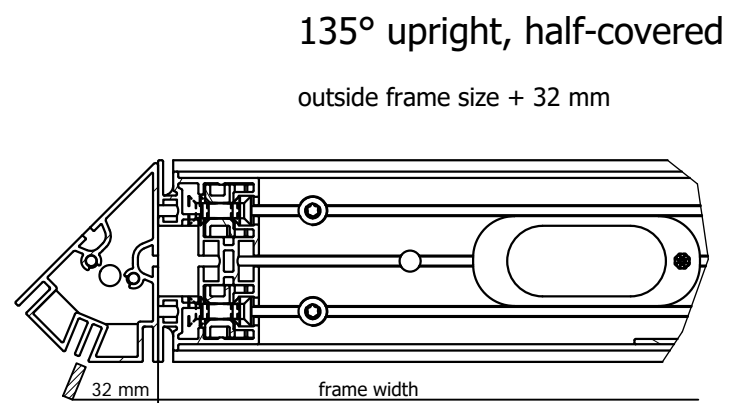
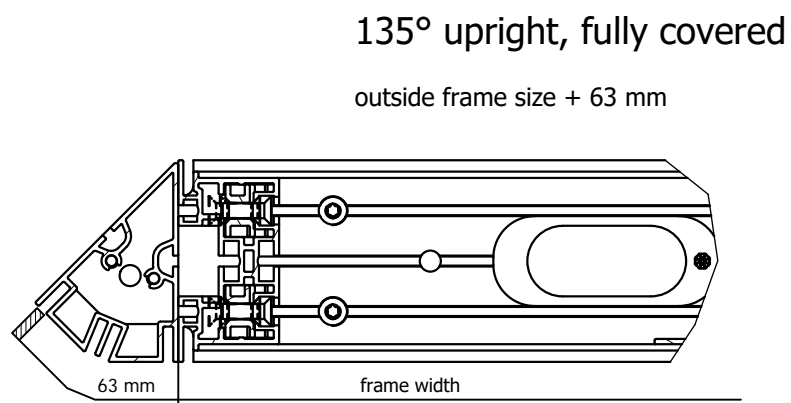
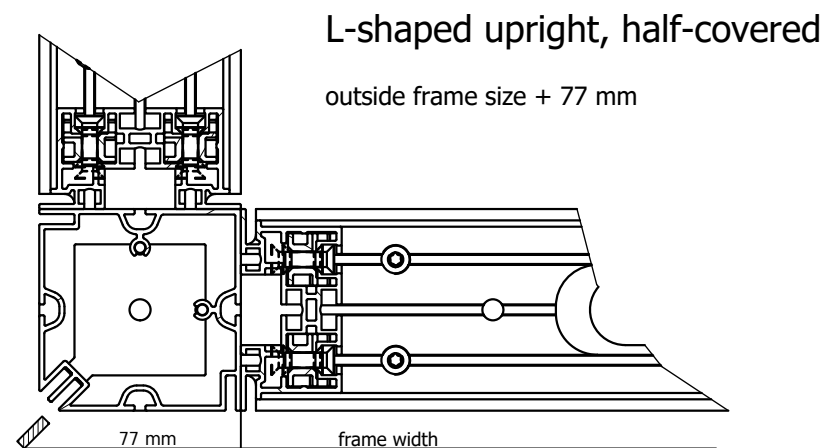
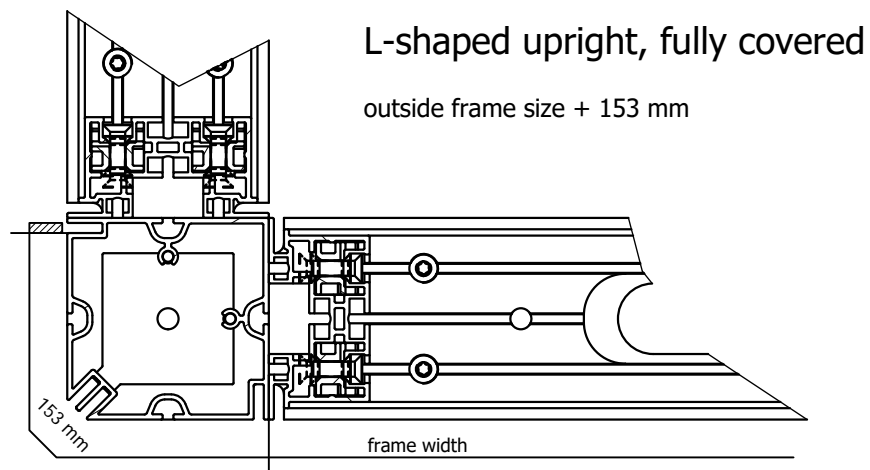

All dimensions in mm!
The drawing remains basically valid!

OCTAwall pro Definition Fabric Dimension for T-Connection WP 820

vertical fabric dim. = outside frame height horizontal fabric dim. = outside frame width

T-Connection Extrusion Fabric Dimensions

horizontal fabric dim. = outer frame edge to middle T-connection extrusion - 34 mm

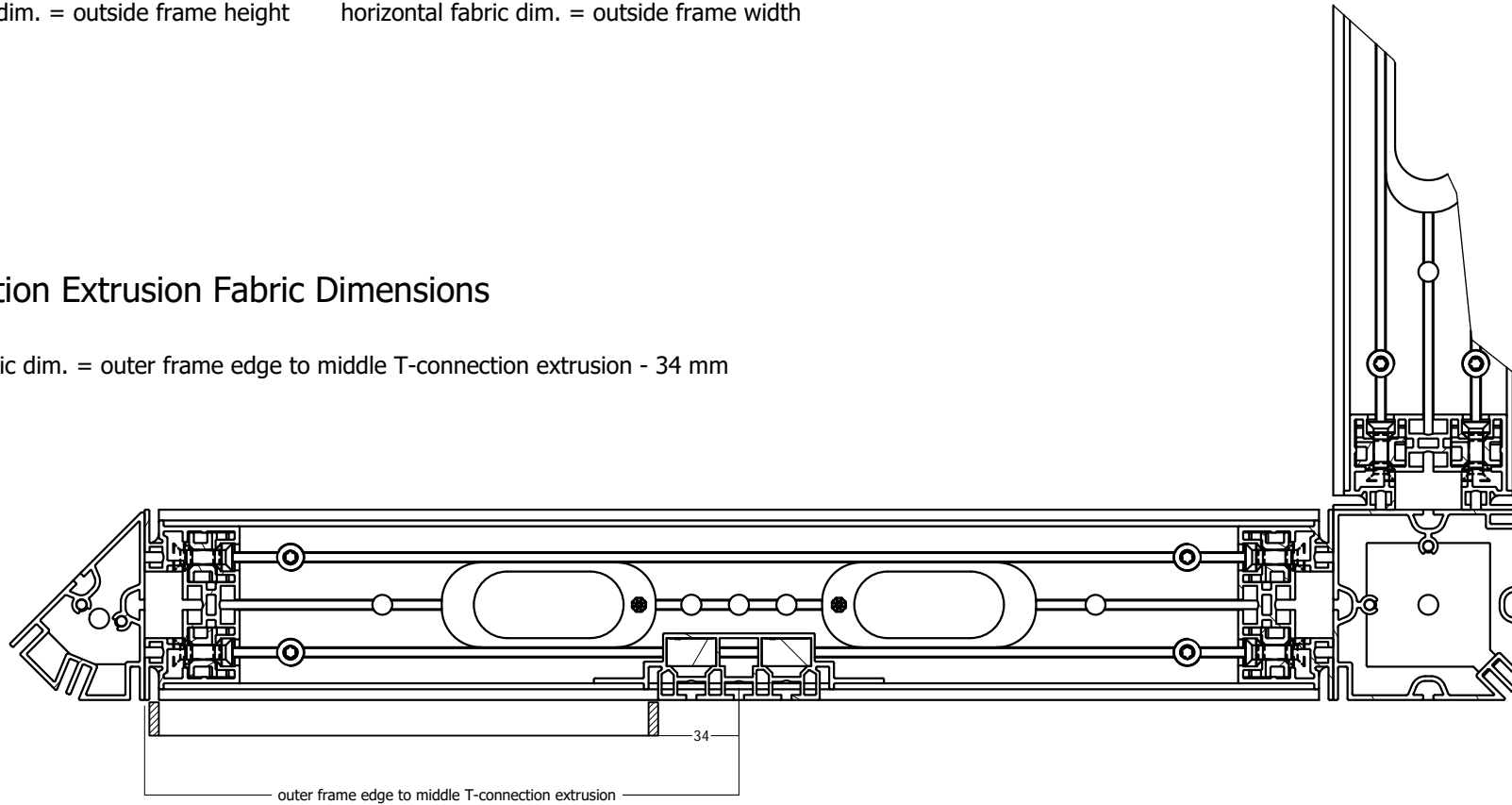

All dimensions in mm!
The drawing remains basically valid!

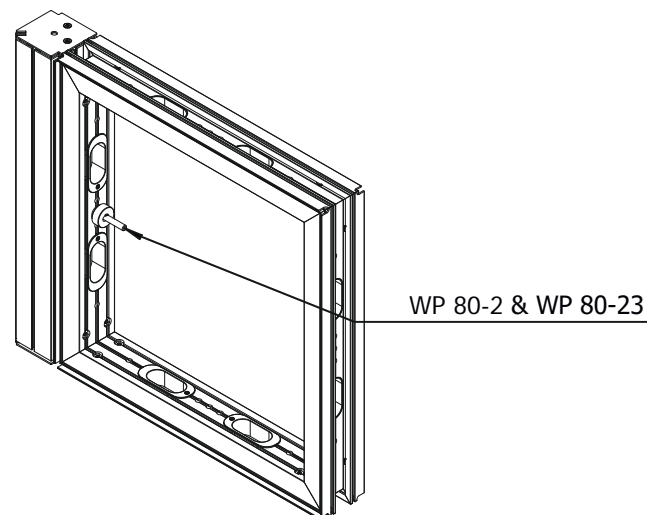
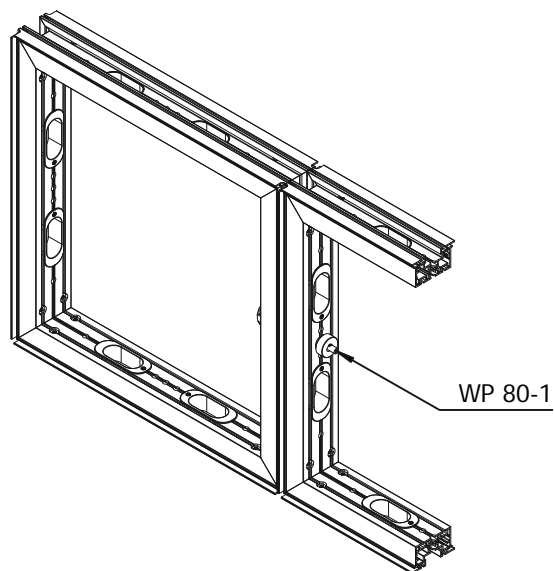

After a 3/4 turn of the quick-release nut, the connection is released. As bolted connections are known to loosen due to vibration, existing screw fittings should be checked carefully e.g. after longer truck transports.

All dimensions in mm!
The drawing with dimensions remain basically valid!

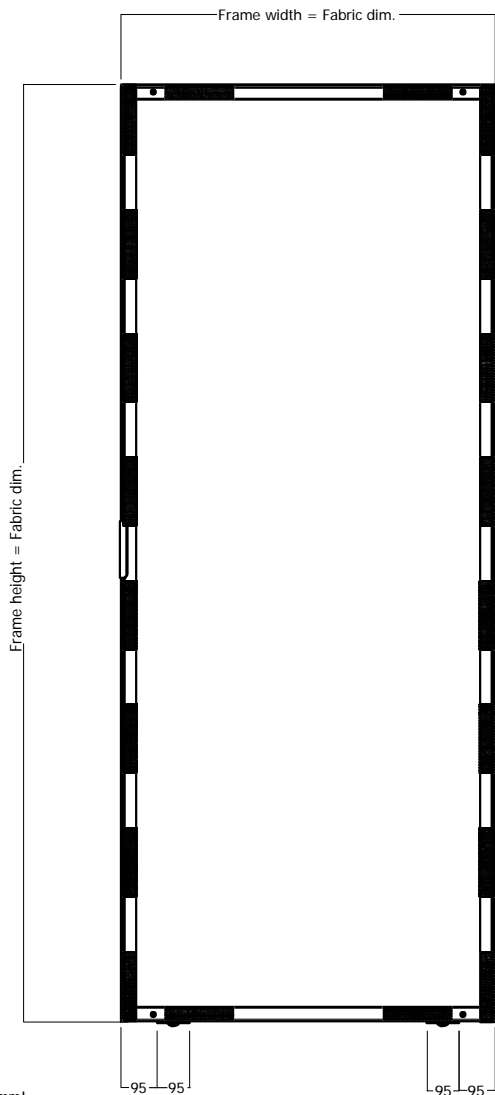

All dimensions in mm!
The drawing remains basically valid!

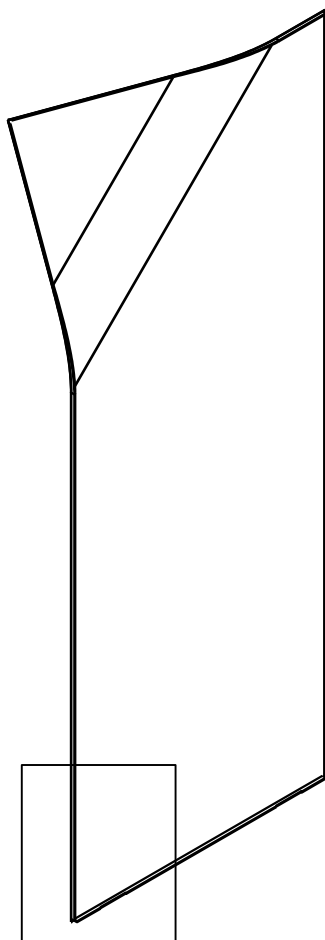

**A silicone edge of 12 x 3 mm must be used for the fabric.
It must be cut out at the positions of the rollers, see the drawing.**

Panel Dimensions

Width: frame width - 5 mm (calculated 1 mm air gap)
Height: frame height - 6 mm (calculated 2 mm air gap)

E.g.: loop tape requirements (mm)	
	H: 2480
W: 990	7400

* The indicated loop tape lengths are also valid for similar frame dimensions.

The "loop tape requirement" is calculated for double-sided paneling of the frame.

Fabric Dimensions

Width: frame width
Height: frame height

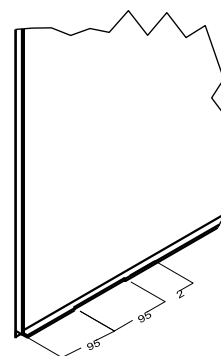

Installation of W 420 sliding door in an octawall pro wall (suitable for octawall pro frames from a width of 950 mm to opening side)

octawall pro

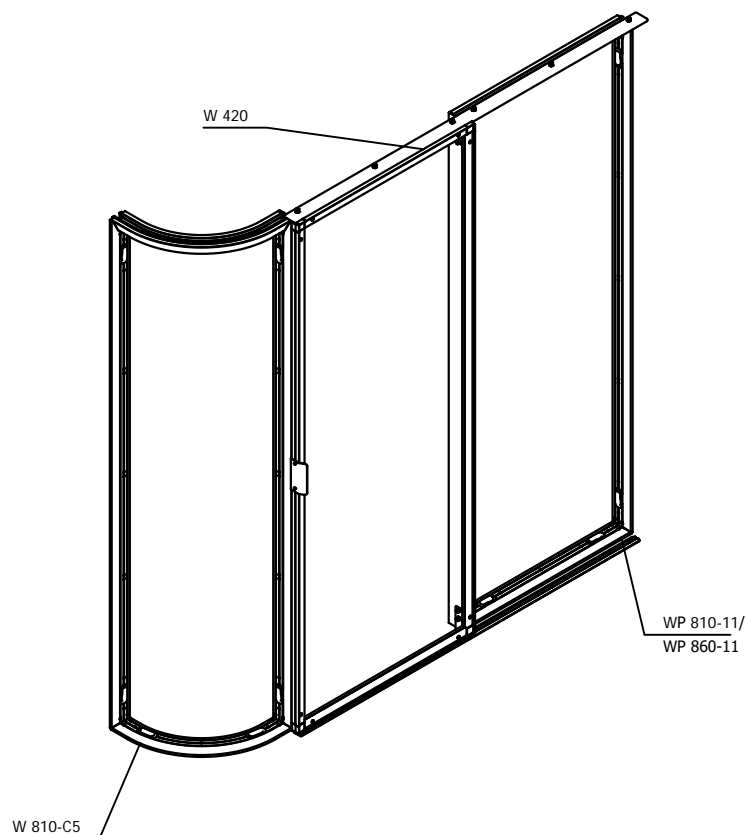

The W 420 sliding door is installed using OL 252 fixing sets. These are on the floor rail W 420-8, the ceiling rail W 420-9 and the guide rail W 420-7 and are mounted in the grooves of the surrounding frames.

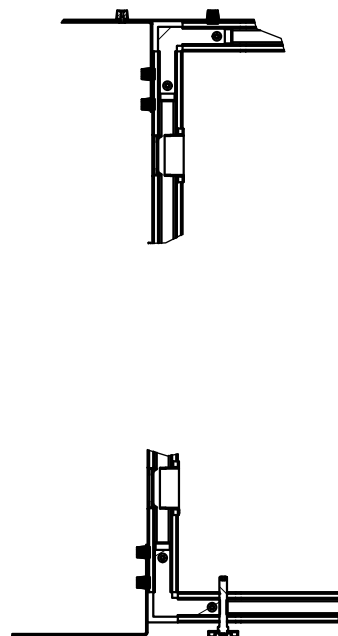

Installation of W 420 sliding door in an octawall 40 wall (suitable for octawall 40 frames from a width of 950 mm to opening side)

octawall 40

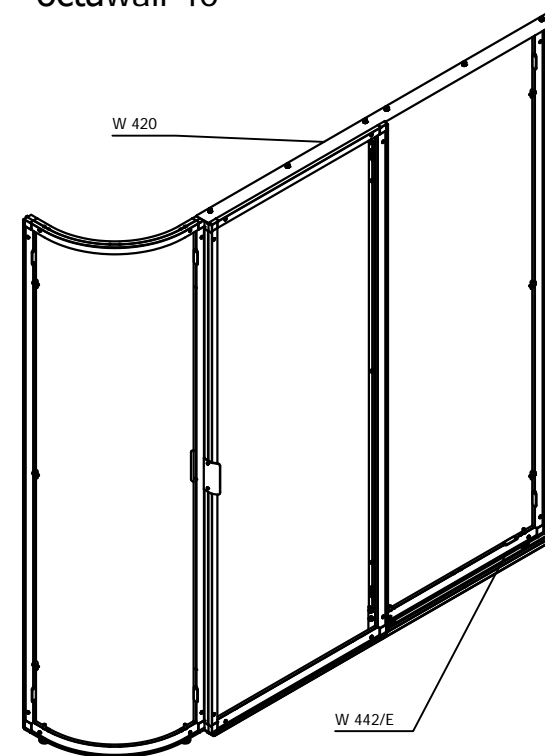

The W 420 sliding door can be used in 4 different ways: inside, outside, and opening to the right or left.

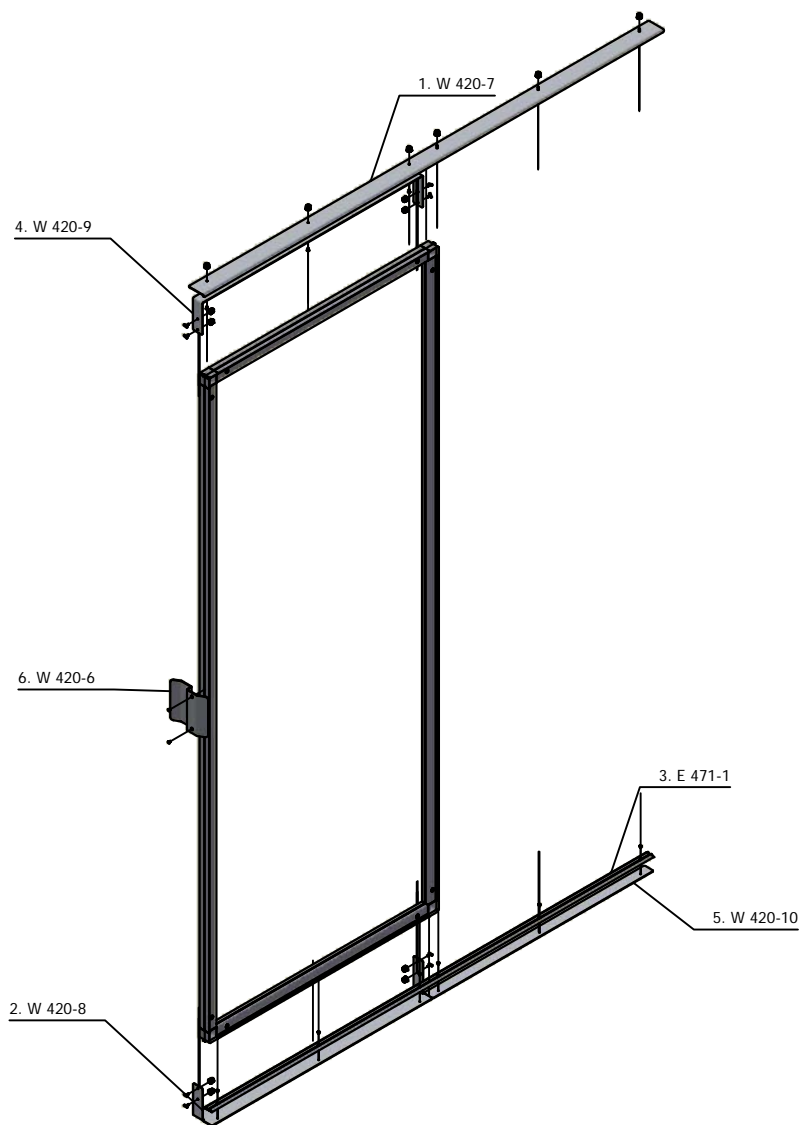

W 420 is a universal sliding door that can be installed in an octawall 40 wall. The door can be installed in 4 different positions, depending on requirements. For this purpose, the door's guide has a modular design. Due to this modular design, the door can be opened to the left or to the right and can be installed either in front of or behind the wall.

The guide consists of the following parts:

1. guide rail W 420-7
2. floor rail W 420-8
3. runner extrusion E 471-1
4. ceiling rail W 420-9
5. bottom plate W 420-10
6. sliding door handle W 420-6

With different arrangement of these parts, the sliding door can be installed in the following mounting variants:

Variant 1: Sliding door opening in front of the wall. Door stop on the right.

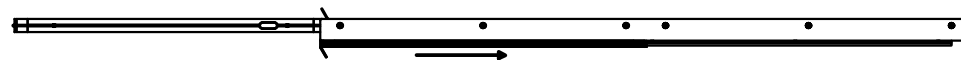

Variant 2: Sliding door opening in front of the wall. Door stop on the left.

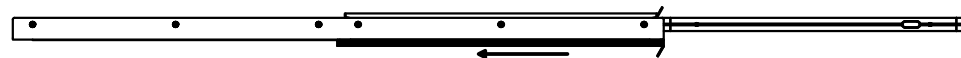

Variant 3: Sliding door opening behind the wall. Door stop on the left.

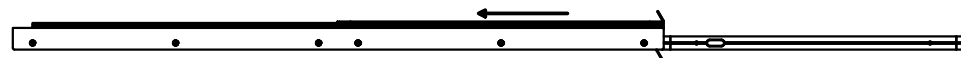

Variant 4: Sliding door opening behind the wall. Door stop on the right.

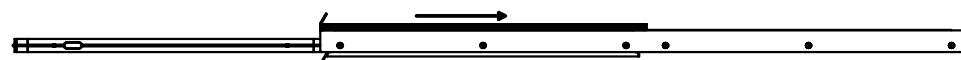

Variant 3: Sliding door opening behind the wall. Door stop on the left.

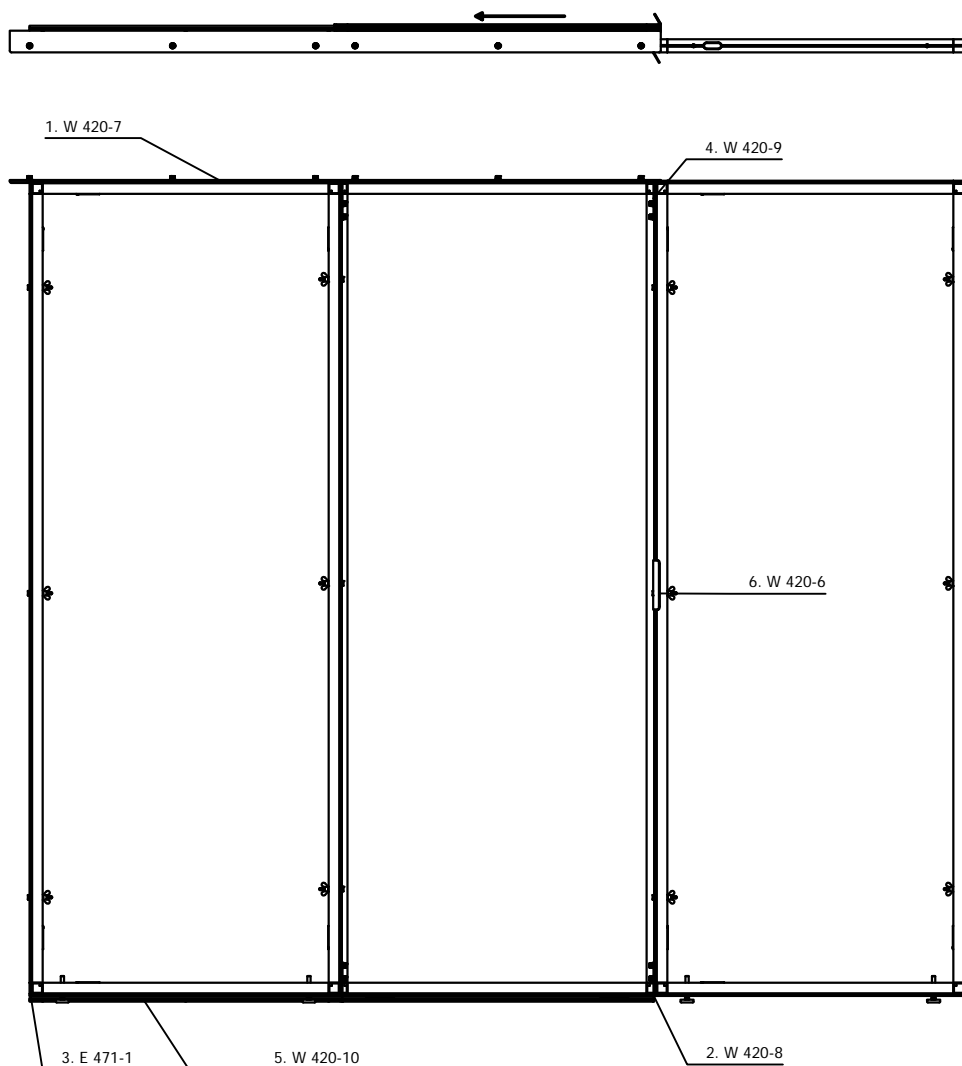

Installation as sliding door opening behind the wall. Door stop on the left.

The guide consists of the following parts:

1. guide rail W 420-7
2. floor rail W 420-8
3. runner extrusion E 471-1
4. ceiling rail W 420-9
5. bottom plate W 420-10
6. sliding door handle W 420-6

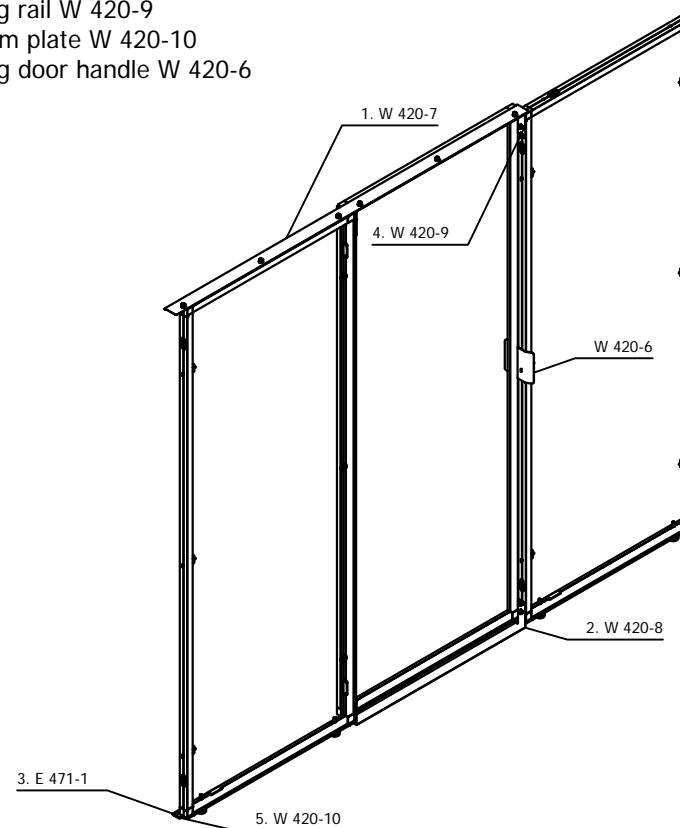

Variant 4: Sliding door opening behind the wall. Door stop on the right.

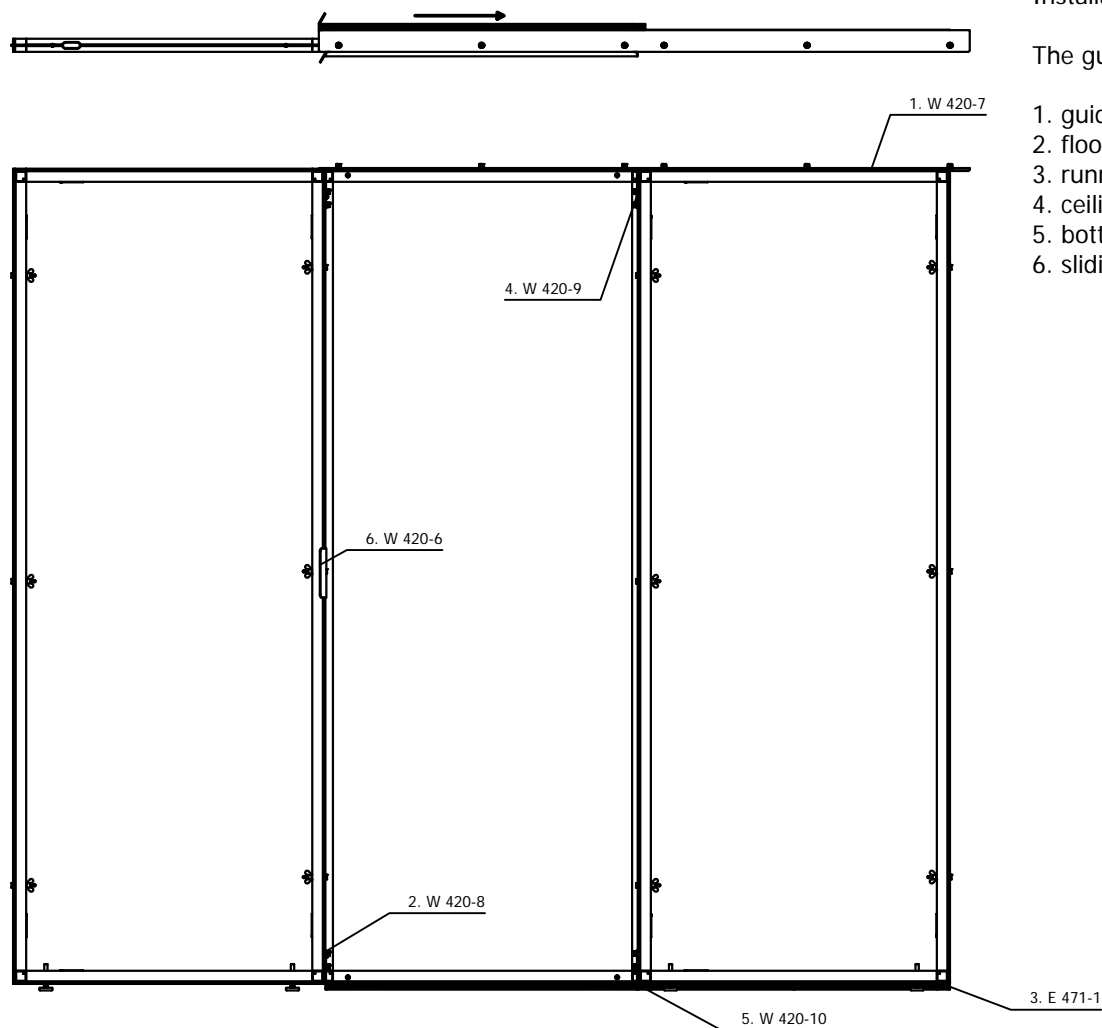

Installation as sliding door opening behind the wall. Door stop on the right.

The guide consists of the following parts:

1. guide rail W 420-7
2. floor rail W 420-8
3. runner extrusion E 471-1
4. ceiling rail W 420-9
5. bottom plate W 420-10
6. sliding door handle W 420-6

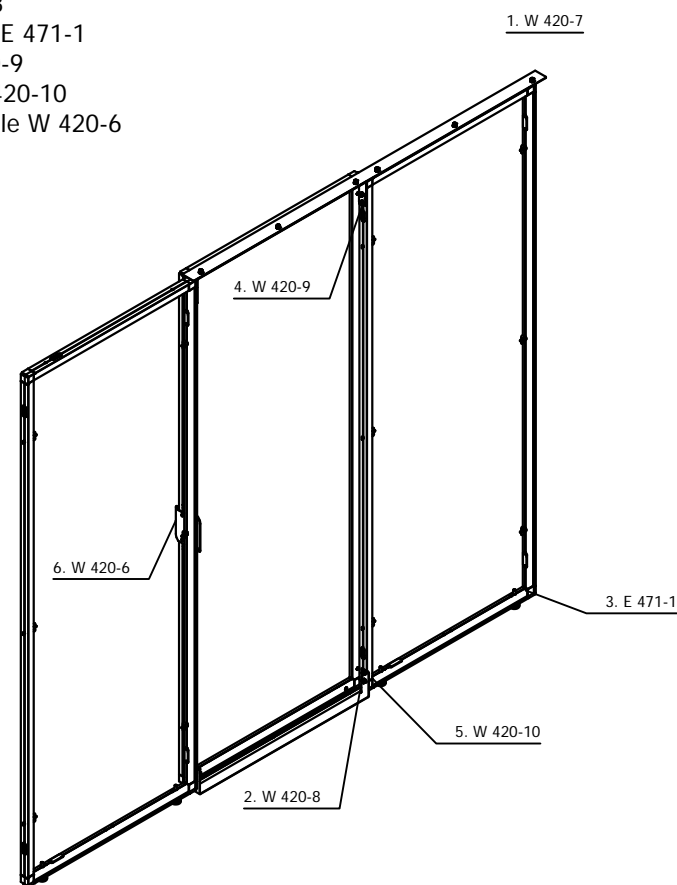

Variante 2: Sliding door opening in front of the wall. Door stop on the left.

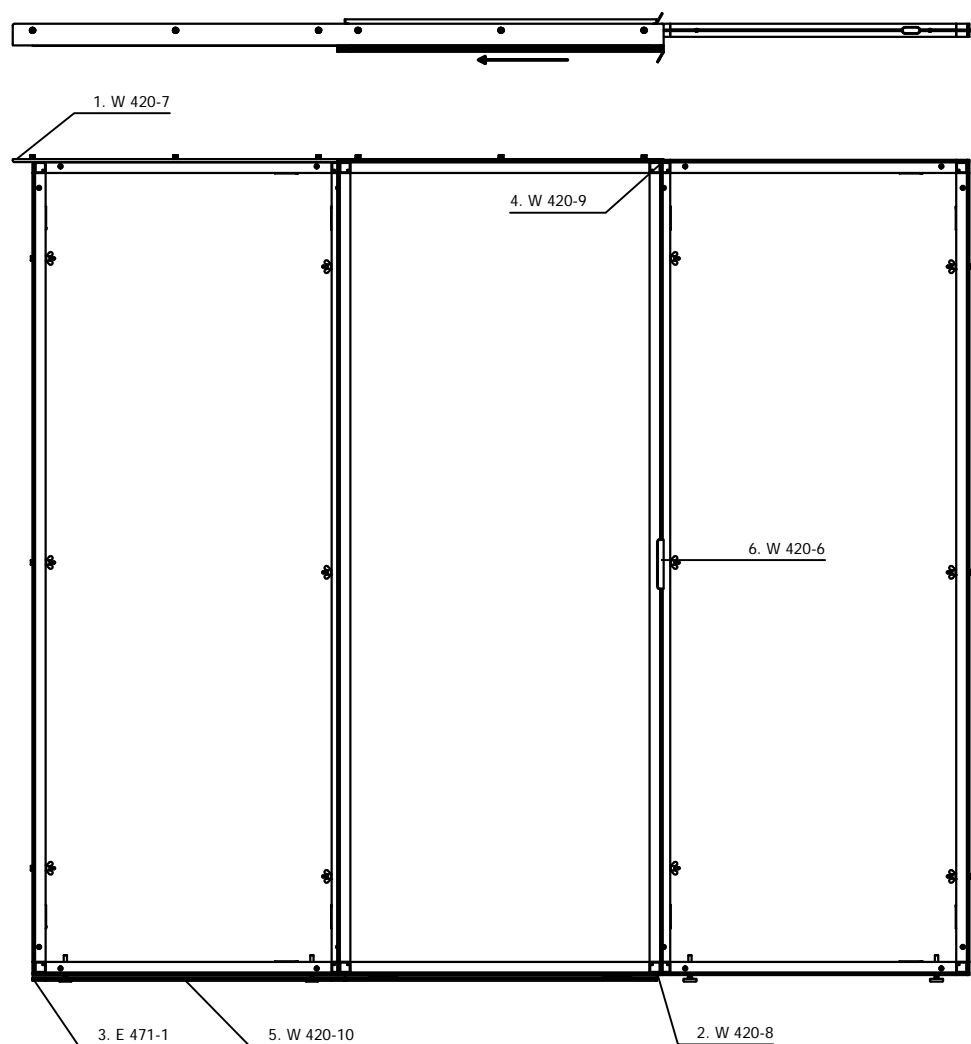

Installation as sliding door opening in front of the wall. Door stop on the left.

The guide consists of the following parts:

1. guide rail W 420-7
2. floor rail W 420-8
3. runner extrusion E 471-1
4. ceiling rail W 420-9
5. bottom plate W 420-10
6. sliding door handle W 420-6

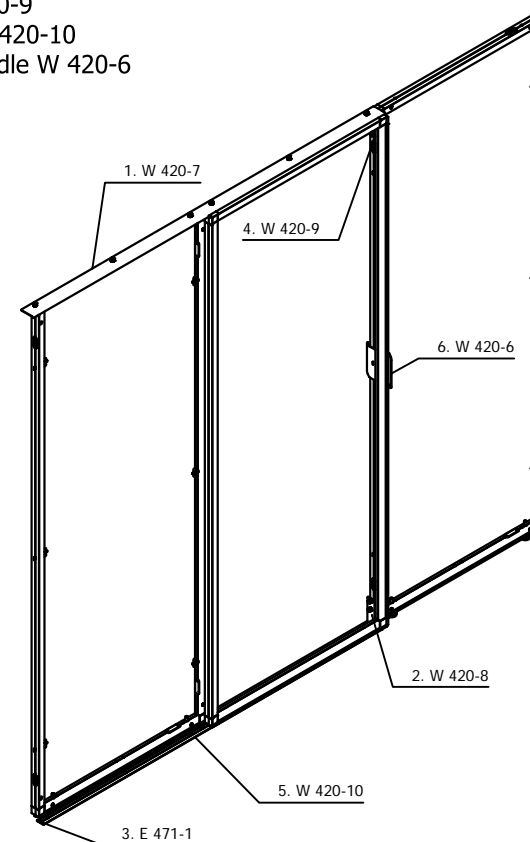

Variante 1: Sliding door opening in front of the wall. Door stop on the right.

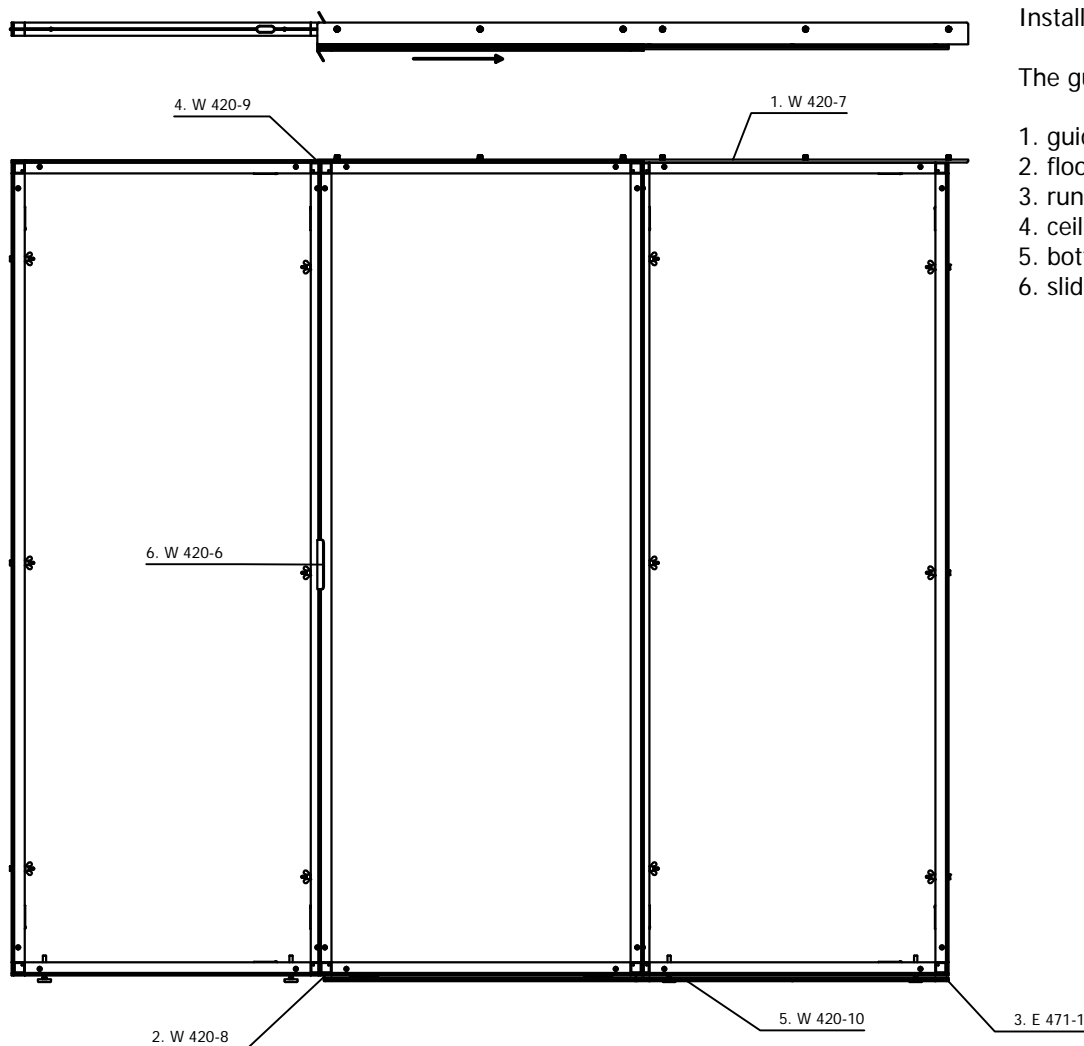

Installation as sliding door opening in front of the wall. Door stop on the right.

The guide consists of the following parts:

1. guide rail W 420-7
2. floor rail W 420-8
3. runner extrusion E 471-1
4. ceiling rail W 420-9
5. bottom plate W 420-10
6. sliding door handle W 420-6

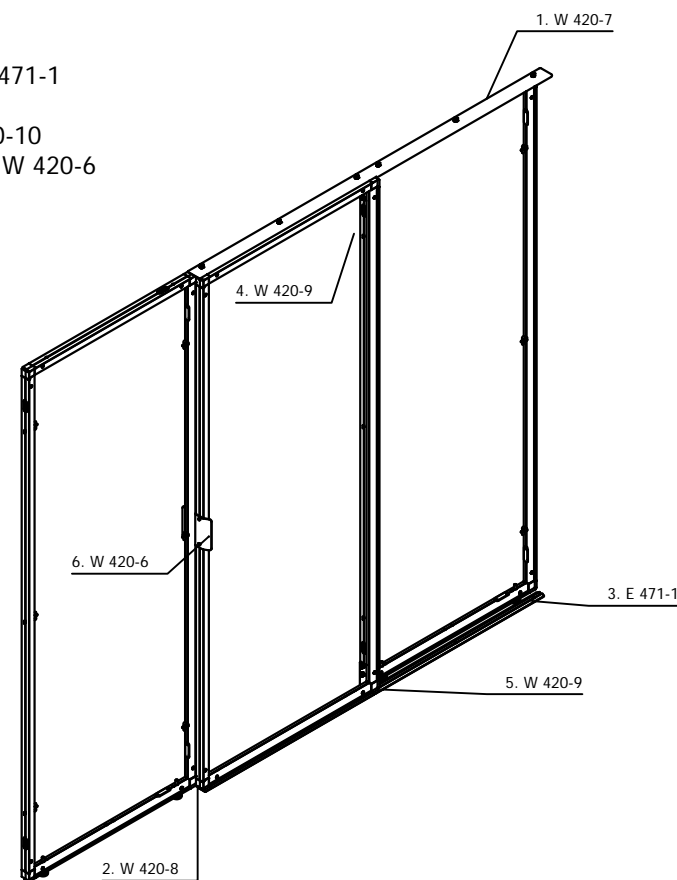

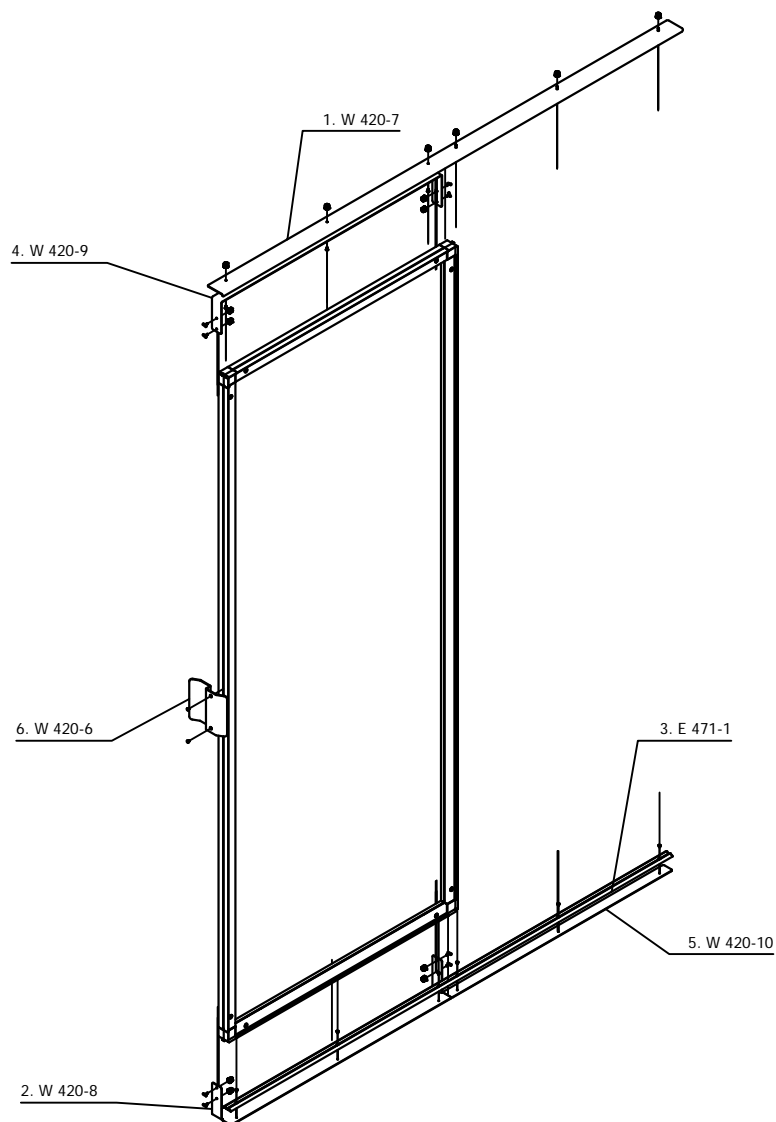

Mounting of the guide rail W 420-7 with ceiling rail W 420-9.

The guide rail W 420-7 is screwed to the ceiling rail W 420-9 with 3 screws DIN 7991 M4x8 and 3 knurled nuts OL 252.

The ceiling rail W 420-9 can be screwed to the guide rail W 420-7 in two different positions.

Position 1: for variants 2 and 4

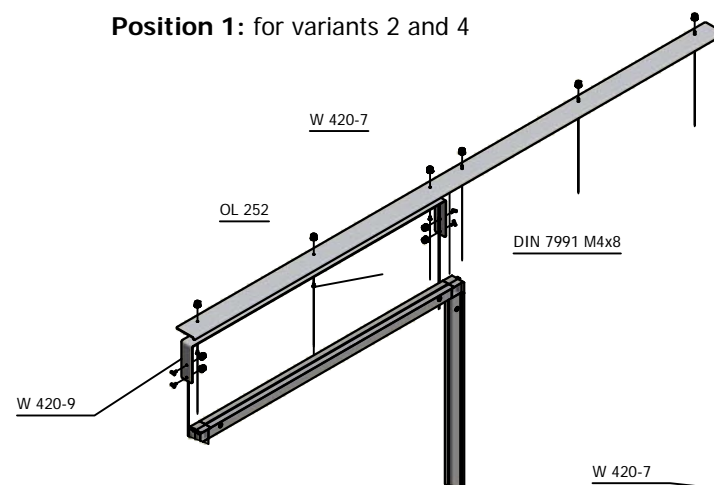

Position 2: for variants 1 and 3

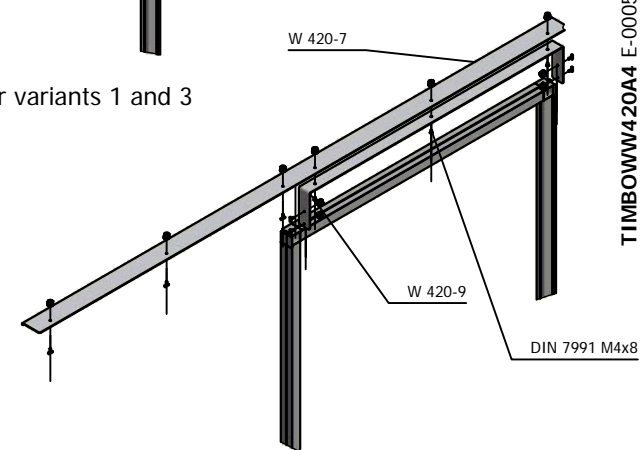

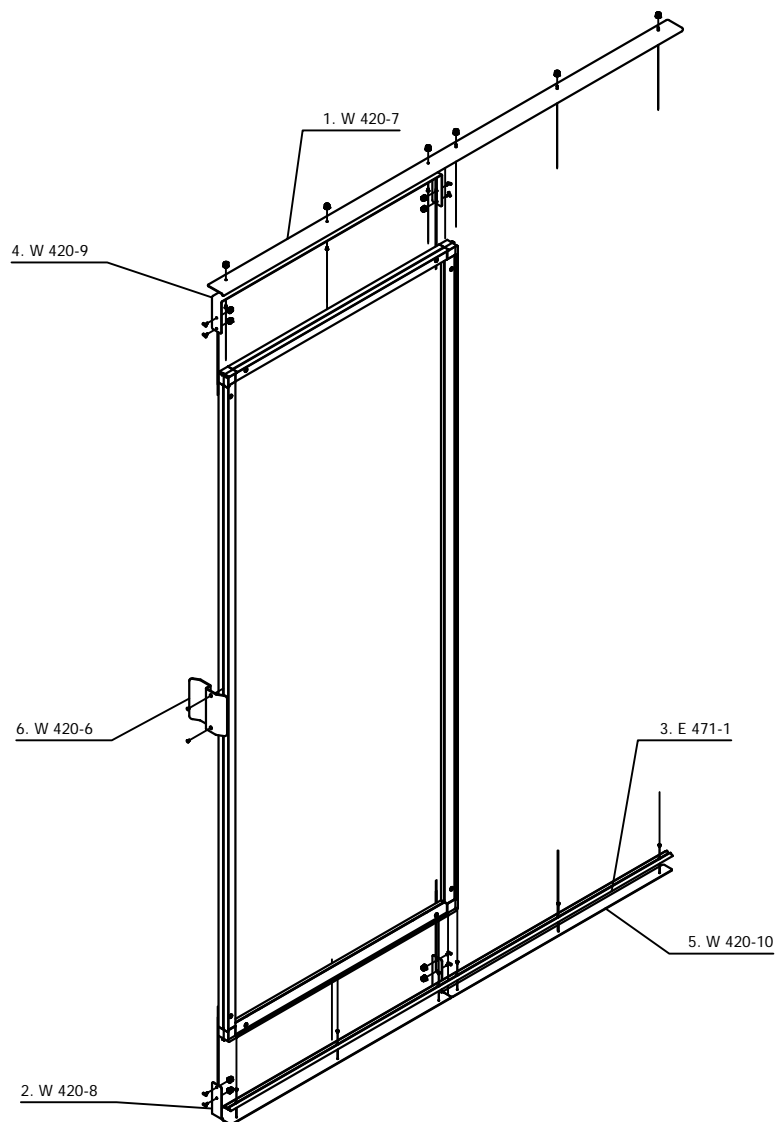

Mounting of bottom rail W 420-8 and bottom plate W 420-10 with runner extrusion E 471-1.

The bottom rail W 420-8 and the bottom plate W 420-10 are screwed to the E 471-1 runner extrusion with 6 DIN 7991 M4x6 screws.

The bottom rail W 420-8 and the bottom plate W 420-10 can be screwed to the E 471-1 runner profile in two different positions.

Position 1: for variants 2 and 4

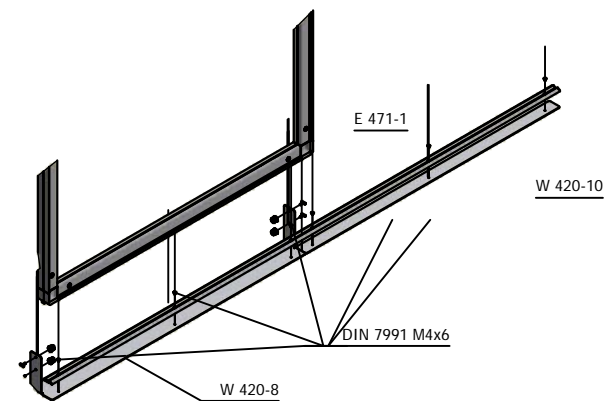

Position 2: for variants 1 and 3

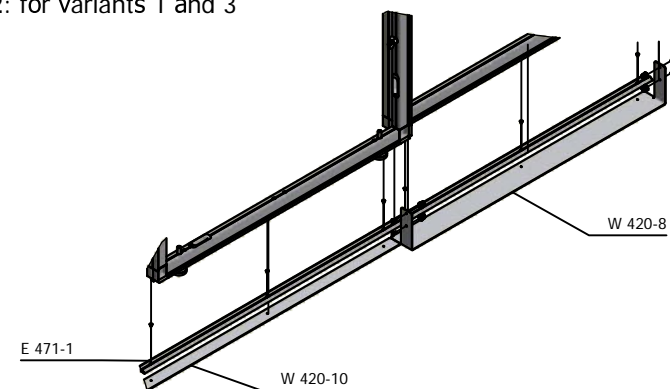

Temperature Resistance

- Temperature range from -10°C to +60°C
- The temperature at which the glue still adheres strongly depends on the surface, the humidity and the applied load

Application/Connection

- Use at room temperature 20°C (+/-5°C)
- Tape with glue and substrate must be at room temperature
- Press firmly together when gluing
- Maximum adherence after 48 hours at room temperature
- Under constant tension or pressure, the glue tends to displace slightly when used with certain fabrics
- The glue is not suitable for reuse

Surface

- Must be free of oil, dirt, dust, moisture, loose particles, monomeric plasticizers, silicones, flaking paint or coating
- Should not be too uneven, fragile, soft or unstable
- Should be suitable for the application of glue
- Should permit good bonding with adhesives, like most metals, wood, ceramics, stone, paper, cardboard, certain fabrics, various hard plastics and foams

Storage/Shelf Life

- In a dry, dark, dust-free and well ventilated room
- At a constant temperature of approx. 20°C (+/-5°C)
- Shelf life with correct storage: 12 months

User Tests/Warranty

- The above information is only for general guidance
- Based on their own tests, users should decide for themselves on the applicability of the fastening

General Instructions for Use

- Do not strain the self-adhesive tape within the first 24 hours after fastening
- Minimum recommended bonding temperature > 10°C
- Degrease the surface, e.g. with alcohol or spirit. The surface must be free of grease, moisture, dust, silicones, etc.
- Remove the protective paper and press the tape firmly in place. Pay particular attention to corners and edges!
- Bonding time: at least 1 hour at room temperature

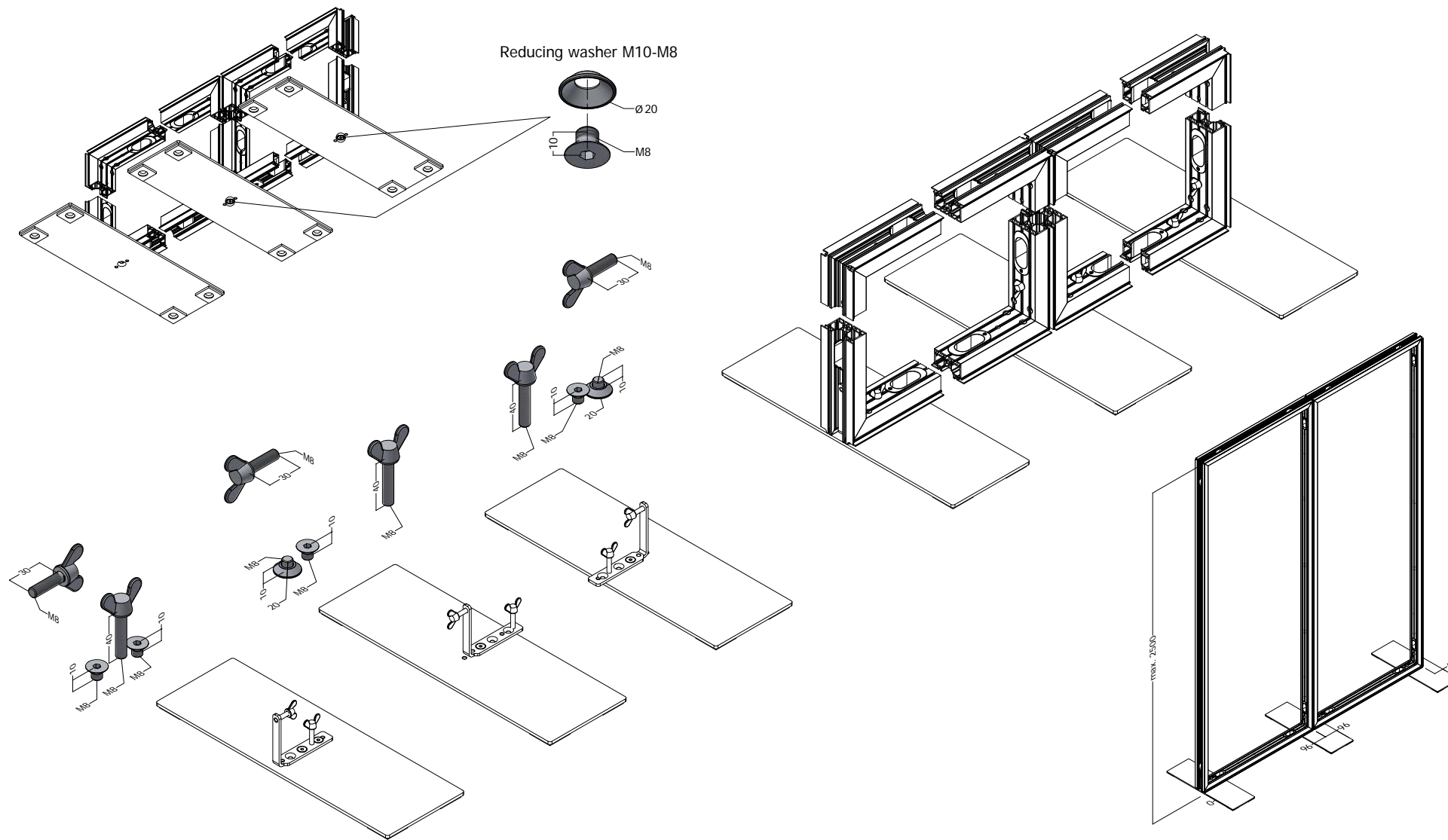

Wallwasher with holding arm, supply line and external converter

The Wallwasher M 1497 is characterized by full-surface illumination across the entire height. An area of 1000 mm width and 2500 mm height is illuminated uniformly and shadow-free with a light output of 3500 lumens - without any hotspots. 5700 K provide a neutral light color and 16 high-power LEDs with lens optics ensure homogeneous illumination.

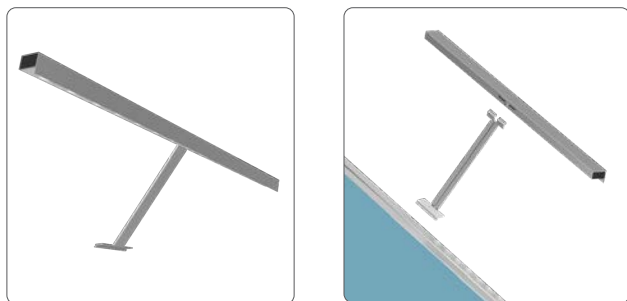

Installation is quite easy

The holding arm is swiveled into the system groove at the desired position. The wallwasher is designed in such a way that it can be integrated into any type of our **octawall** and **maxima** series from 40 - 120 mm. The only requirement is a system groove at the top of the extrusion. The supply cable is 1000 mm from converter to lamp, and 2500 mm from converter to 100-230V socket.

Space saving and secure packing

The light element and the holding arm are two separate components that are connected by simply hooking them into each other. This allows all components to be stored in one package to save space.

Cleaning and care instructions

Before cleaning, disconnect the lamp from the power supply. Do not use any corrosive or abrasive cleaning agents, but clean the lamp dry, e.g. with a microfiber cloth.

➤ Item N°:	M 1497
➤ Light Color:	5700 K
➤ Surface:	silver matt
➤ Dimmer:	dimmmable via external dimmer

2. Technical Data

➤ Manufacturer:	OCTANORM-Vertriebs-GmbH für Bauelemente Raiffeisenstraße 39 70794 Filderstadt T. +49 711 77007-30 www.octanorm.com
➤ Item:	Wallwasher
➤ Description:	Wallwasher with holding arm and external power supply unit (24V/36W) dimmmable via external dimmer (not included)
➤ Properties:	W 812 × H 263 × D 166 mm from center of groove
➤ Dimensions:	Aluminium, matt powder-coated
➤ Material Housing:	Plastic matt black
➤ Material Lateral Surface:	230V/50Hz, 5700 K/28 W
➤ Connection:	16 pcs
➤ Number of LEDs:	IP 20
➤ Housing Protection:	SKII
➤ Electrical Protection Class:	5700 K
➤ Light Color:	3600 lm/125lm/W
➤ Luminous Flux/lm per Watt:	Energy efficiency class A
➤ Efficiency:	100% direct beam, asymmetrisch wide beam
➤ Light Distribution:	RA > 90

Average rated life of the light source: L80 > 50.000 hours

1. Assembly of lamp head and holding arm

Insert the holding arm into the milled holes until you feel resistance. Then tilt the holding arm without working against any resistance, so that it engages in the millings. In this position, the lamp head can no longer detach from the holder. To detach the holder from the light head again, follow the steps in reverse order.

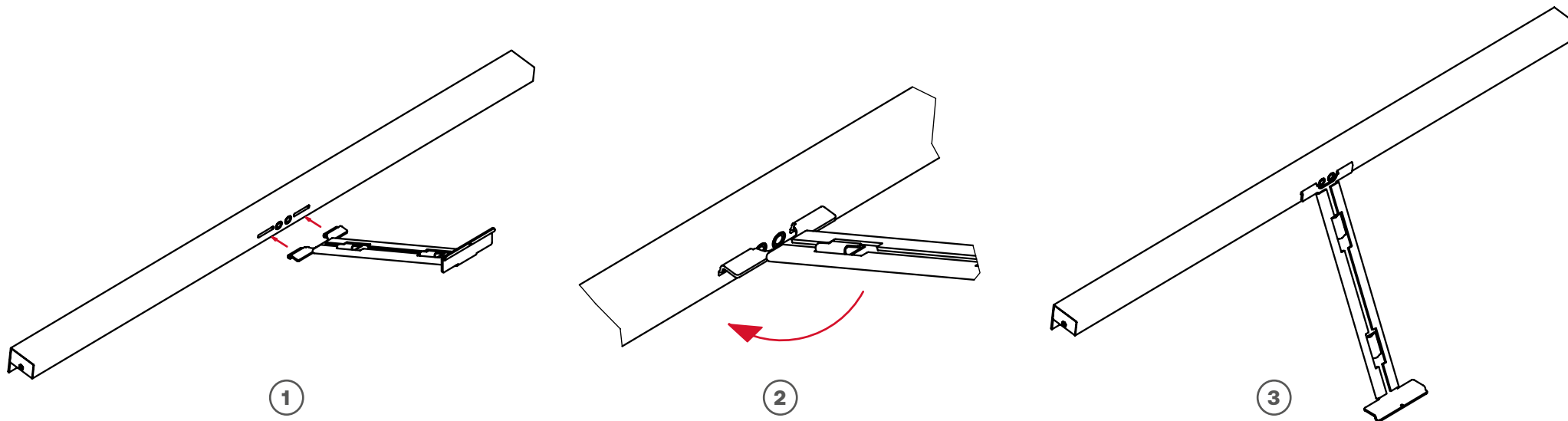

2. Installation of the lamp in the system groove

Swivel the lamp with the mounted arm into the extrusion groove. The holding arm is aligned so that it perfectly illuminates a height of 2.5 m. Be careful not to bend the arm.

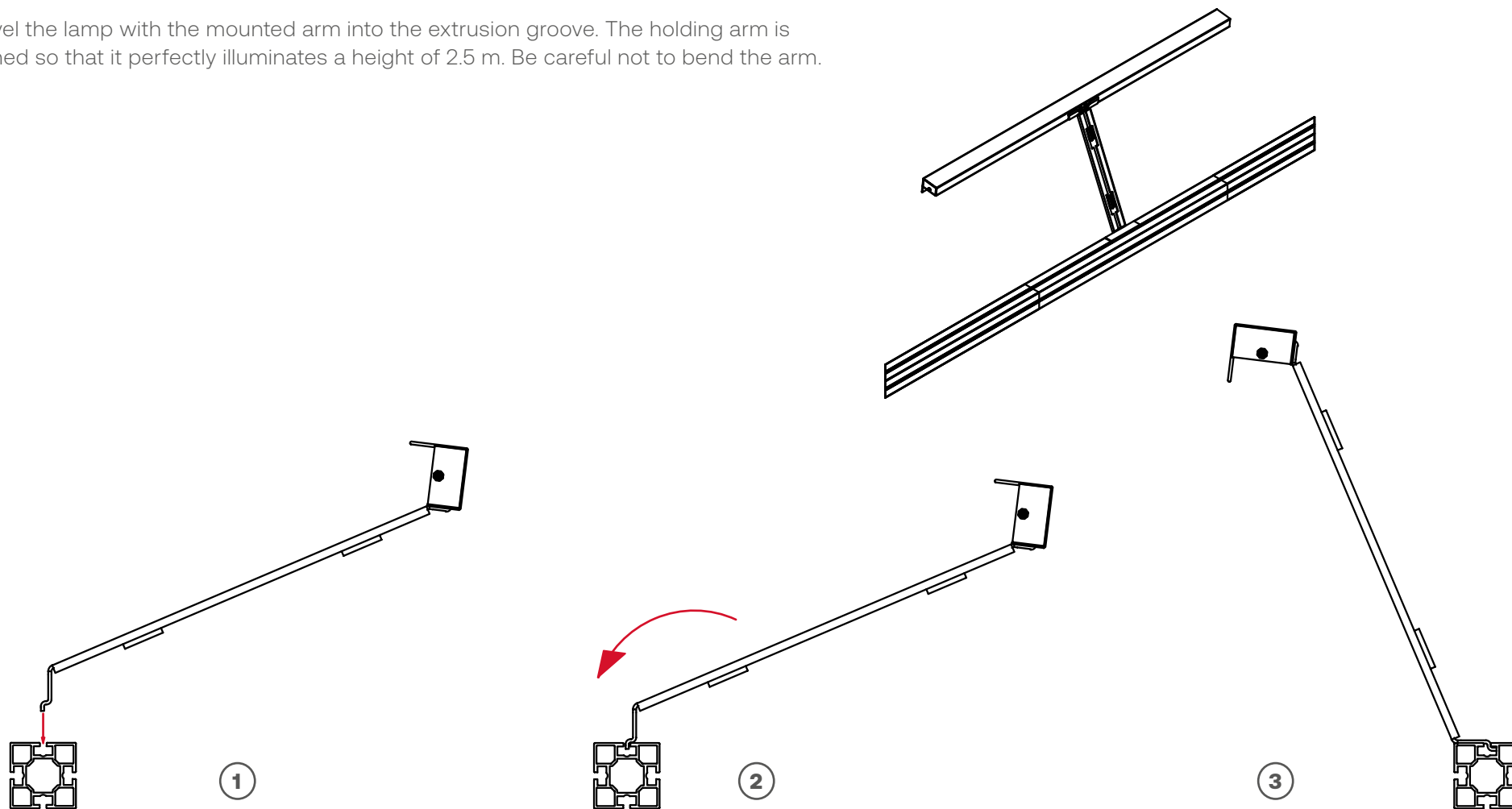

3. Wiring

A power supply unit is supplied together with the lamp for connection. The power supply cable is plugged into one of the sockets on the light head to supply the lamp with power. The remaining socket can be used with a forwarding cable if further wallwashers are to be connected in series. The remaining cable can be inserted into the retaining clips on the holding arm to take the strain off the cable all the way to the power supply.

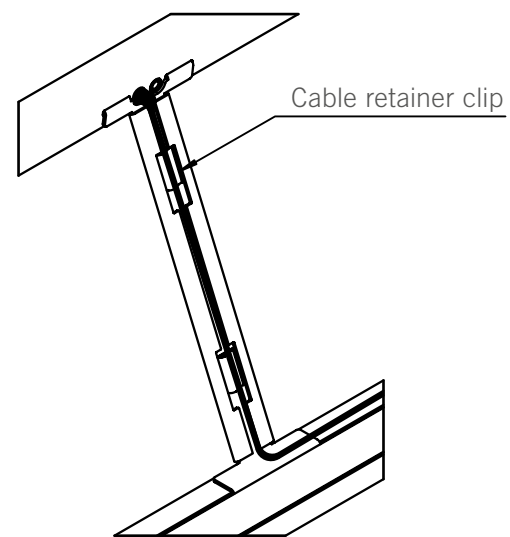
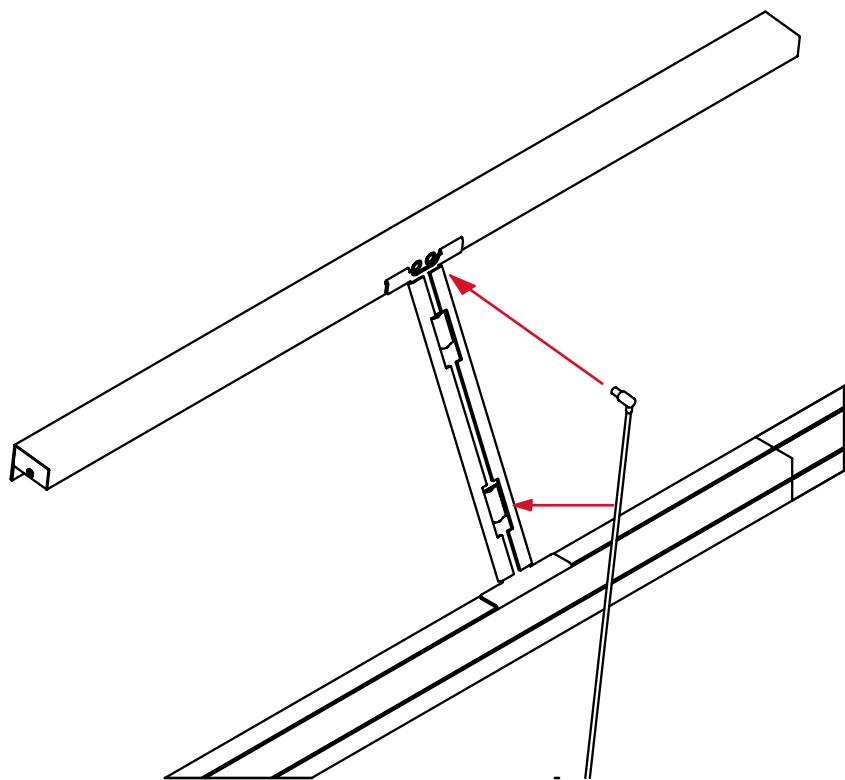

Wiring

Interconnect a maximum of 5 wallwashers per 160W power supply unit.

Connect a maximum of 3 wallwashers in series after a 160W power supply or a Y-splitter that is connected after a power supply.

Danger!

Never connect more than 5 wallwashers to one M1497-11 power supply unit and never more than 3 in series.

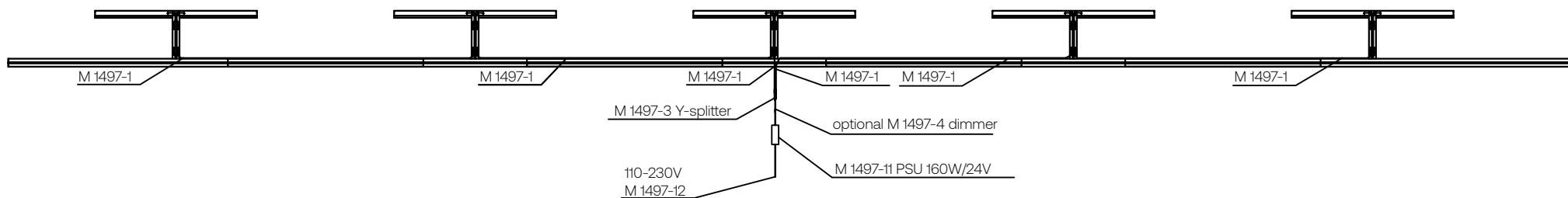

Used components:

6 × M 1497-1
connection cable

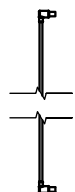

1 × M 1497-3
Y-splitter



1 × M 1497-12
power cord

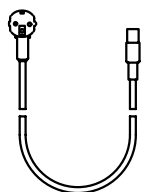

1 × M 1497-11
PSU 160W/24V



optional 1 × M 1497-4
dimmer



M 1497-H Wallwasher Hanging Lamp

TI-WW-3.0 1/4



- Item N°: M 1497-H
- Light Color: 5700 K
- Surface: black matt
- Dimmer: dimmable via external dimmer

Wwallwasher as hanging lamp, with supply live and external converter

The Wallwasher M 1497-H is characterized by full-surface illumination across the entire height. An area of 1000 mm width and 2500 mm height is illuminated uniformly and shadow-free with a light output of 7200 lumens - without any hotspots. 5700 K provide a neutral light color and 32 high-power LEDs with lens optics ensure homogeneous illumination.

- homogenous illumination of 1000 mm width and 2500 mm height
- luminous flux 7200 lm, > Cri 90
- height adjustable by Reutlinger stainless steel suspension set
- 5700 K ensure a neutral light colour
- energy-saving and durable LEDs
- with dimming option

➤ technical information

Technical Data

- Manufacturer: OCTANORM-Vertriebs-GmbH für Bauelemente
Raiffeisenstraße 39
70794 Filderstadt
Germany
T. +49 711 7700-30
www.octanorm.com
- Item: M 1497-H Wallwasher hanging lamp
- Description: Hanging lamp with power supply unit incl. DC distributor, 3 m extension cable with DC connector
dimmable via external dimmer (not included)
- Properties:
- Dimensions: L 818 × W 150 × H 36 mm
- Material Housing: Aluminium, black matt powder-coated
- Material Lateral Surface: Plastic black matt
- Suspension: 3,5 m wire rope with 2 × Reutlinger stainless steel suspension set for height adjustment
- Connection: 230V/50Hz, 5700 K/56 W
- Number of LEDs: 32 pcs
- Housing Protection: IP 20
- Electrical Protection Class: SKII
- Light Color: 5700 K
- Luminous Flux/lm per Watt: 7200 lm/128lm/W
- Efficiency: Energy efficiency class A
- Light Distribution: 100% direct beam, asymmetric wide beam RA > 90

Average rated life of the light source: L80 > 50.000 hours

Cleaning and care instructions

Before cleaning, disconnect the lamp from the power supply. Do not use any corrosive or abrasive cleaning agents, but clean the lamp dry, e.g. with a microfiber cloth.

Assembly and suspension of the lamp

Insert the wire ropes from above into the two wire rope holders until the loose ends emerge again through the side opening. Provide a suitable mounting option on the ceiling for suspension of the lamp. Use the wire rope eyelets to hang the lamp directly from the ceiling or from a beam. Level the lamp by adjusting the length of the wire ropes and/or the wire rope holders.

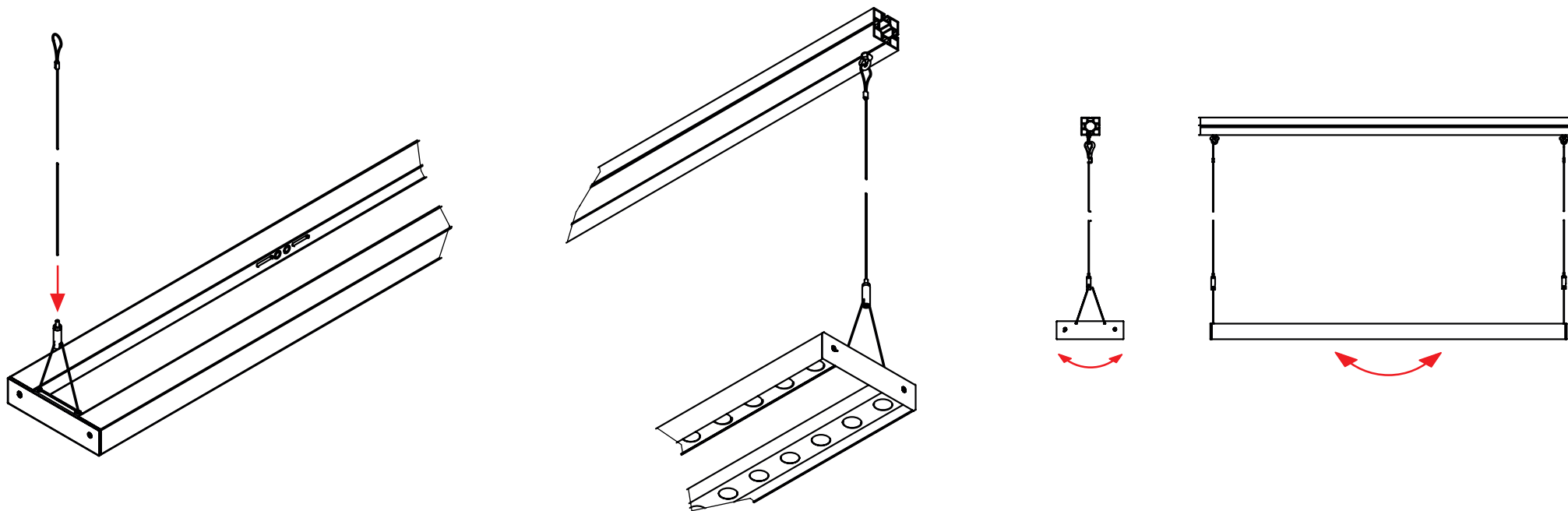

Cabling

The two plugs of the DC distribution cable are plugged into one of the two sockets on the lamp heads on each side. The other sockets on the lamp heads remain unused. The DC distributor cable is led upwards and plugged into the cable of the power supply unit.

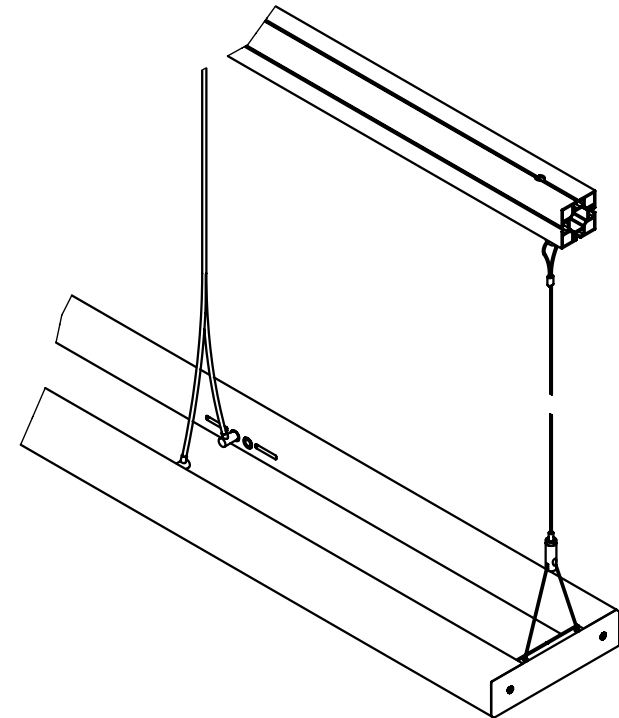
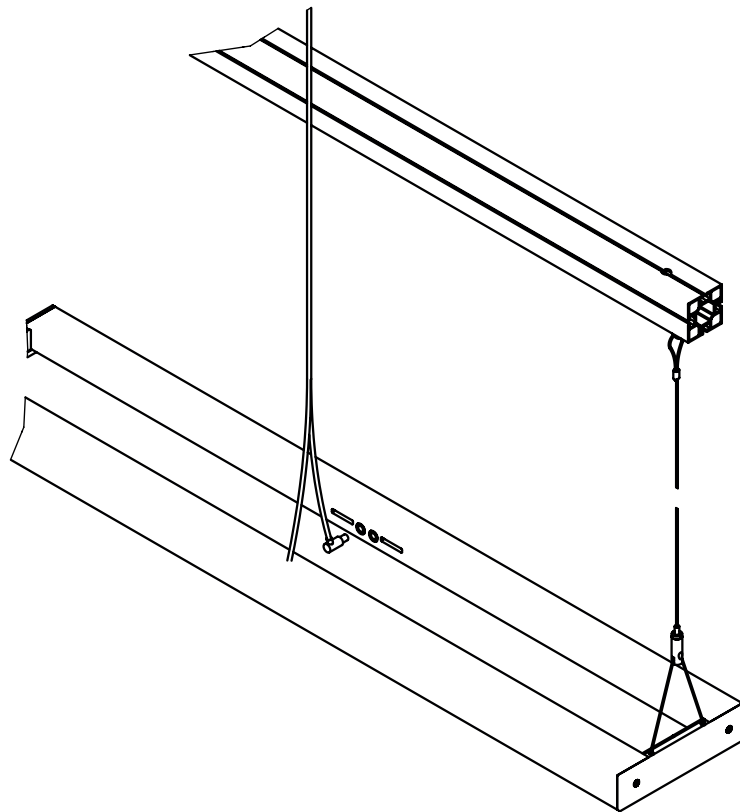

Wiring

Interconnect a maximum of 2 hanging lamps per 160W power supply unit.

Attention!

Never connect more than 2 hanging lamps to one M1497-11 power supply unit.

Always use a Y-splitter between power supply unit and hanging lamps.

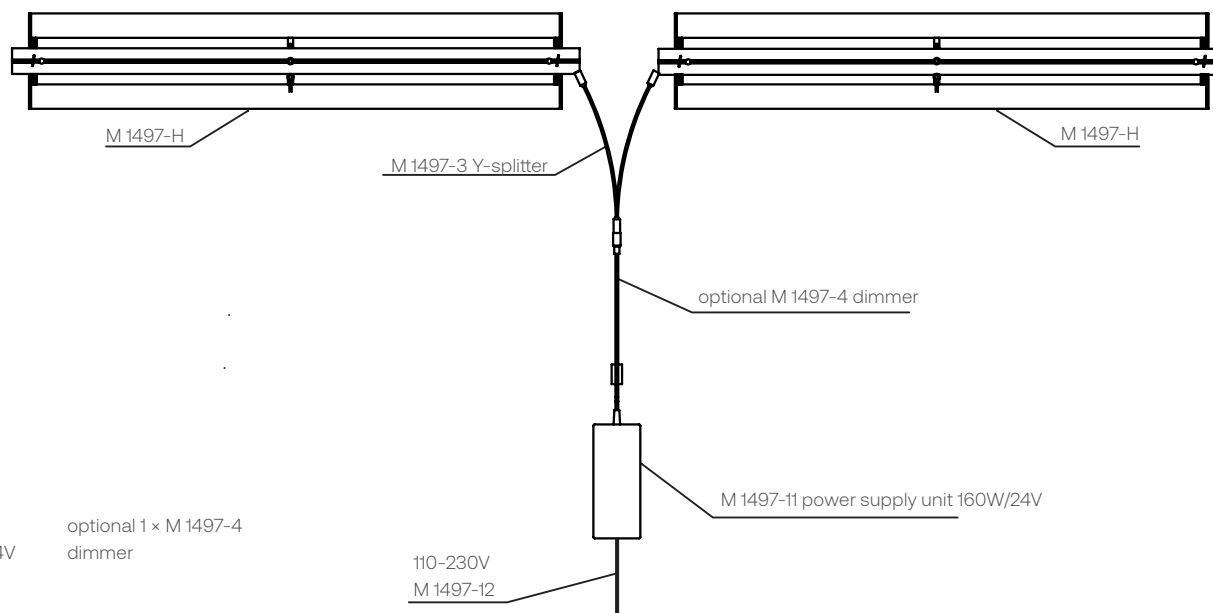

Used components:

1 x M 1497-3
Y-splitter



1 x M 1497-12
power cord

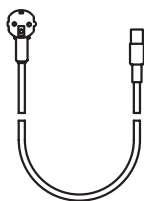

1 x M 1497-11
power supply unit 160W/24V



optional 1 x M 1497-4
dimmer



- Item N°: M 1497
- Light Color: 5700 K
- Surface: silver or black matt
- Dimmer: dimmable via external dimmer

Wallwasher with holding arm, supply line and external converter

The Wallwasher M 1497 is characterized by full-surface illumination across the entire height. An area of 1000 mm width and 2500 mm height is illuminated uniformly and shadow-free with a light output of 3500 lumens - without any hotspots. 5700 K provide a neutral light color and 16 high-power LEDs with lens optics ensure homogeneous illumination.

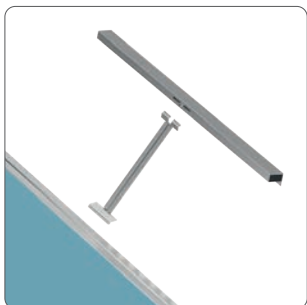

Installation is quite easy

The holding arm is swiveled into the system groove at the desired position. The wallwasher is designed in such a way that it can be integrated into any type of our octawall and maxima series from 40 - 120 mm. The only requirement is a system groove at the top of the extrusion. The supply cable is 1000 mm from converter to lamp, and 2500 mm from converter to 100-230V socket.

Space saving and secure packing

The light element and the holding arm are two separate components that are connected by simply hooking them into each other. This allows all components to be stored in one package to save space.

Technical Data

- Manufacturer: OCTANORM-Vertriebs-GmbH für Bauelemente
Raiffeisenstraße 39
70794 Filderstadt
T. +49 711 7700-30
www.octanorm.com
- Item: Wallwasher
- Description: Wallwasher with holding arm and external power supply unit (24V/36W)
- Properties: dimmable via external dimmer (not included)
- Dimensions: B 812 × H 263 × T 166 mm from center of groove
- Material Housing: Aluminium, matt powder-coated
- Material Lateral Surface: Plastic matt black
- Connection: 230V/50Hz, 5700 K/28 W
- Number of LEDs: 16 pcs
- Housing Protection: IP 20
- Electrical Protection Class: SKII
- Light Color: 5700 K
- Luminous Flux/lm per Watt: 3600 lm/125lm/W
- Efficiency: Energy efficiency class A
- Light Distribution: 100% direct beam, asymmetrisch wide beam
RA > 90

Average rated life of the light source: L80 > 50.000 hours

Cleaning and care instructions

Before cleaning, disconnect the lamp from the power supply. Do not use any corrosive or abrasive cleaning agents, but clean the lamp dry, e.g. with a micro-fiber cloth.

Assembly of lamp head and holding arm

Insert the holding arm into the milled holes until you feel resistance. Then tilt the holding arm without working against any resistance, so that it engages in the millings. In this position, the lamp head can no longer detach from the holder. To detach the holder from the light head again, follow the steps in reverse order.

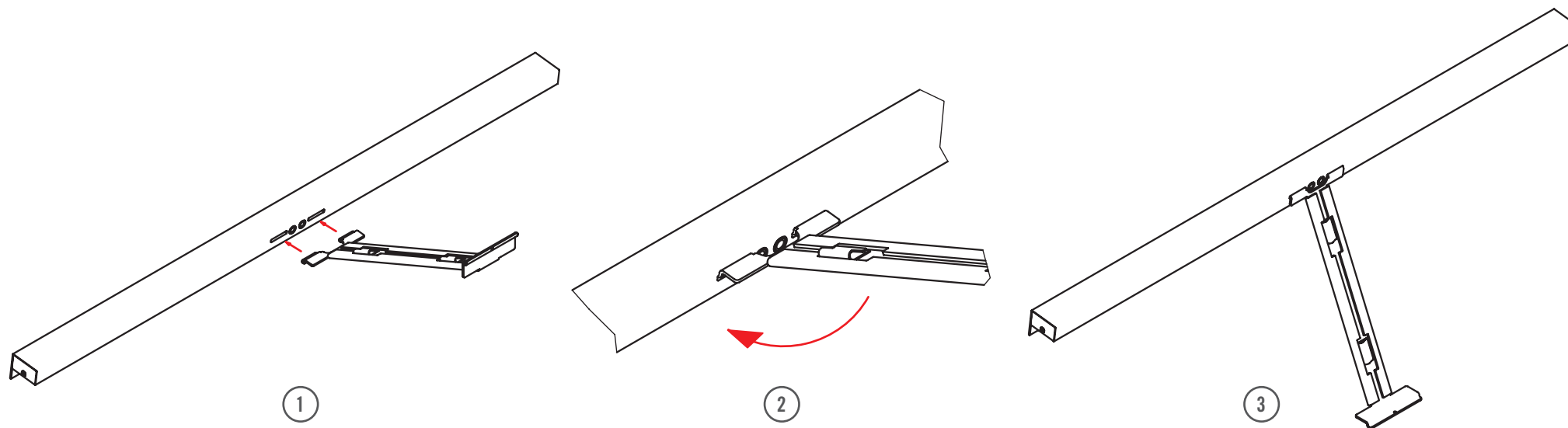

Installation of the lamp in the system groove

Swivel the lamp with the mounted arm into the extrusion groove. The holding arm is aligned so that it perfectly illuminates a height of 2.5 m. Be careful not to bend the arm.

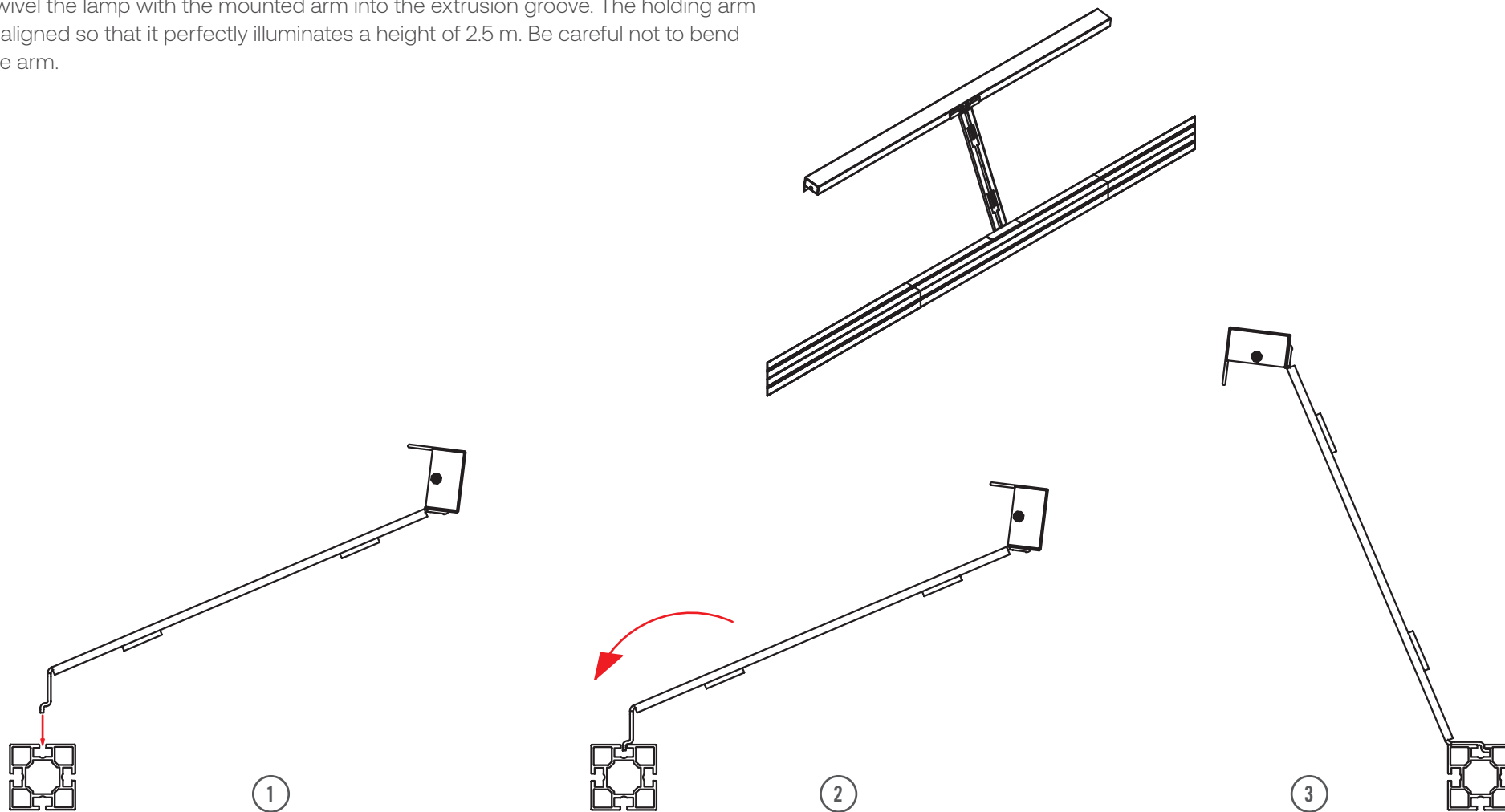

Wiring

A power supply unit is supplied together with the lamp for connection. The power supply cable is plugged into one of the sockets on the light head to supply the lamp with power. The remaining socket can be used with a forwarding cable if further wallwashers are to be connected in series. The remaining cable can be inserted into the retaining clips on the holding arm to take the strain off the cable all the way to the power supply.

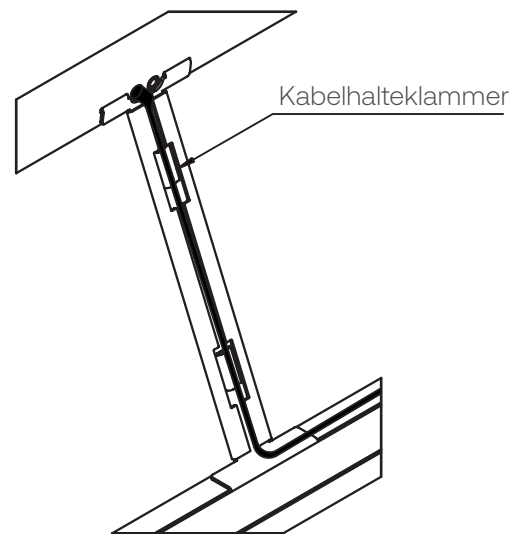
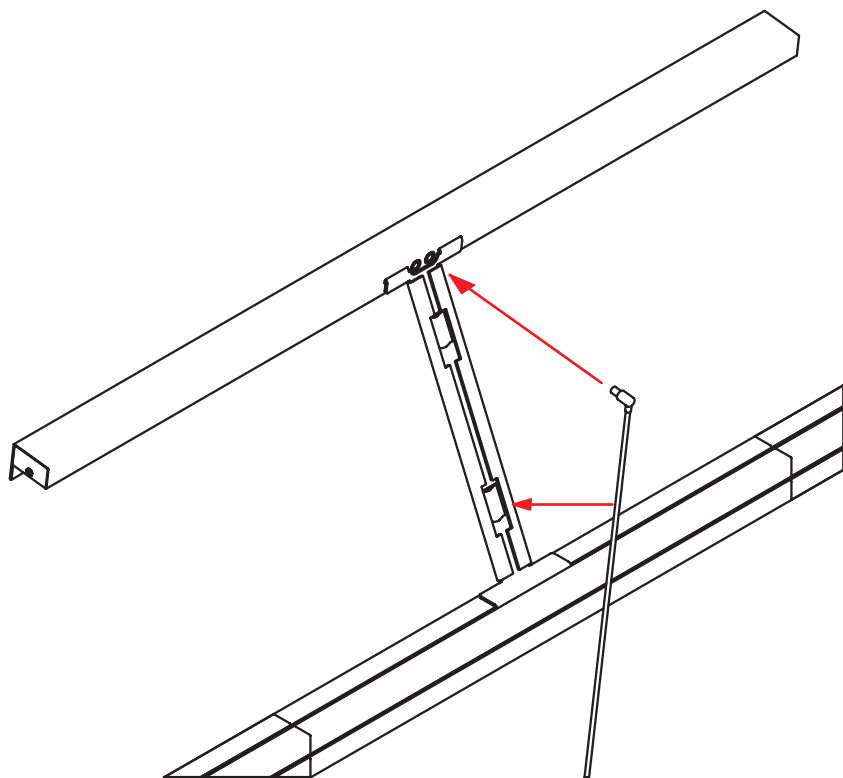

Wiring

Interconnect a maximum of 5 wallwashers per 160W power supply unit.
 Connect a maximum of 3 wallwashers in series after a 160W power supply or a Y-splitter that is connected after a power supply.

Attention!

Never connect more than 5 wallwashers to one M1497-11 power supply unit and never more than 3 in series.

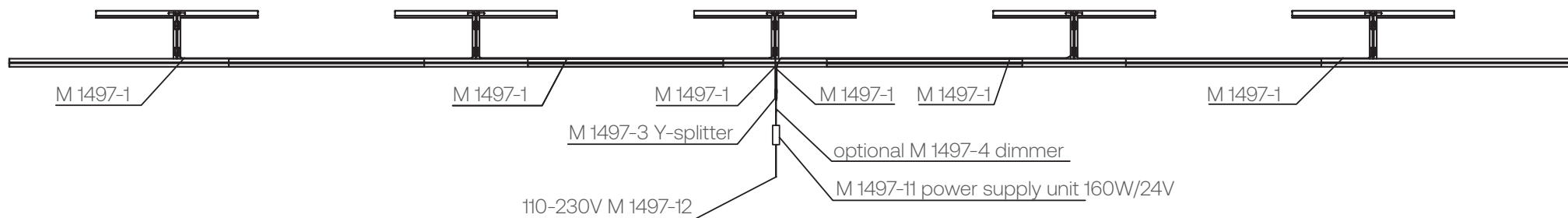

Used components:

6 × M 1497-1
connection cable

1 × M 1497-3
Y-splitter

1 × M 1497-12
power cord

1 × M 1497-11
power supply unit 160W/24V

optional 1 × M 1497-4
dimmer

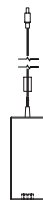
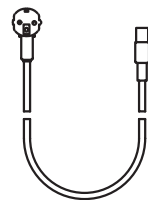



Mini wireless-sync-control led dimmer with touch remote

Controller adopts the most advanced PWM (Pulse Width Modulation) digital control technology, it is used for controlling constant voltage LED lamps. For instance, point source of light, flexible light strip, led modules, led strings and so on.

1. Product Features

- Designed for M 1497 wallwasher
- DC12-24V, output current: 1ch*6A(DIM)
- Adopts RF remote control, no need line-of-sight
- Wireless-sync-control in both static color and dynamic modes, unlimited by remote control distance
- Batch-operation is available for RF code matching/clearing between remote control and receivers
- Memory function, each time power-on reserve the mode which stop in the last power-off
- Perfect control effect, soft dim function
- Long-press the brightness and speed key can get the fast adjustment, convenient for operation
- Also adopts Button function for switch on/off and change color
- Warranty of this product is one year, exclude the artificial situation of damaged or overload working

2. Technical Parameters

Touch Remote Control

- Working temperature: -20 - 60°C
- Standby current: 8uA
- Standby power: 36uW
- Net weight: 65g
- RF distance: ≤20m
- Supply voltage: 4.5V (AAA 3pcs)
- Working current: 30mA
- Working power: 135mW
- External dimension: L 150 × W 40 × H 20 mm
- RF frequency: 433.92MHz

Controller

- Working temperature: -20 - 60°C
- Static power consumption: <1W
- Grayscale: infinitely variable
- External dimension: L 48 × W 26 × H 13 mm
- Net weight: 20g
- RF frequency: 2.4GHz
- Output color order settable: Yes, RGB/RGBW
- Output: DIM 1 CH
- PWM frequency: 1.95KHz
- Supply voltage: DC 12V-24V
- Speed stage: infinitely variable
- Packing size: L 100 × W 65 × H 40 mm
- Gross weight: 40g
- RF distance: ≤20m
- Memory function: Yes
- Output current: ≤6Am (total) DIM:1 × 6A
- Max. Output power: 12V: <72W, 24V: <144W

3. Dimension

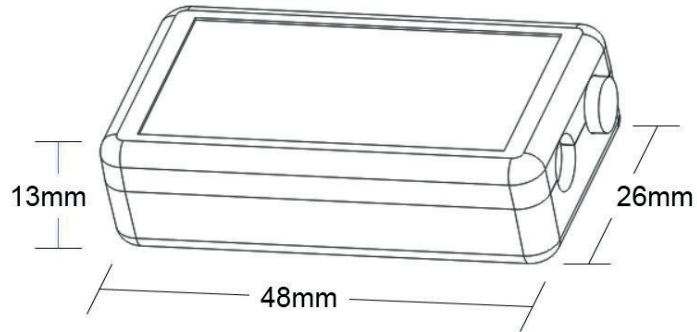

4. Interface Specifications

Input port: DC plug (2.1/5.5)



Output port: DC plug for DIM



Button



5. Direction for Use

Wireless-synchronization function

Receivers will transmit the control signals from the remote control and self-inspection the work statuses for each other, so multiple receivers in same zone will wireless-sync-work completely, not only static mode but also dynamic mode, to achieve wired-like operation experience.

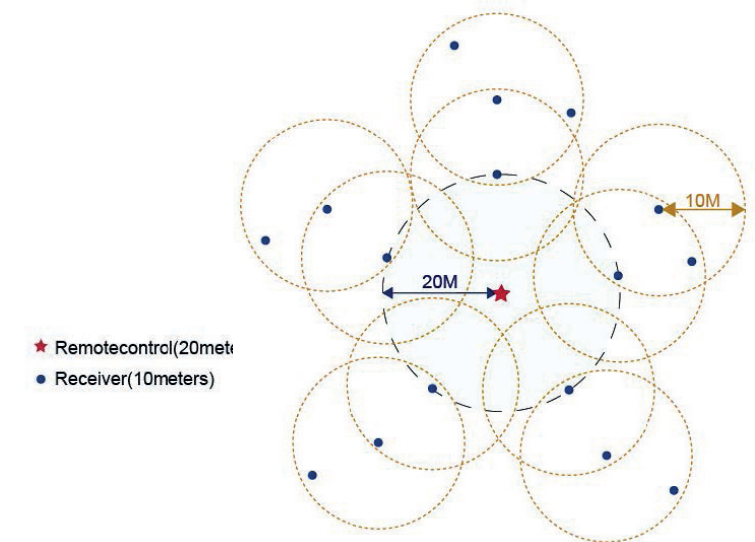

Button Control Function

- Short pressing to switch on/off the light in any time.
- Long-pressing during the controller in working state, the output light brightness, just release press when you get the correct brightness.

6. Touch Remote

Adopts RF full touch control, with one dimming ring and 5 function buttons.

Tips: Without any operation more than 20 seconds, the touch remote will enter the sleep state, please **shake** the remote to wake up it before the next using.



Name of key	Instruction	Remarks
Off	Off in any time	
On	On in any time	
Mode	The mode will go to next, when you touch the key each time	2 modes in total: fade or flash (speed is adjustable, brightness is unadjustable)
Speed/Brightness +	The speed/brightness will +1, when you touch the key each time	Speed for dynamic modes, brightness for static modes
Speed/Brightness -	The speed/brightness will -1, when you touch the key each time	Speed for dynamic modes, brightness for static modes
Dimming Ring	For brightness selection	

7. Typical Applications

Application Circuit 1: Single color (DC plug 2.1/5.5)

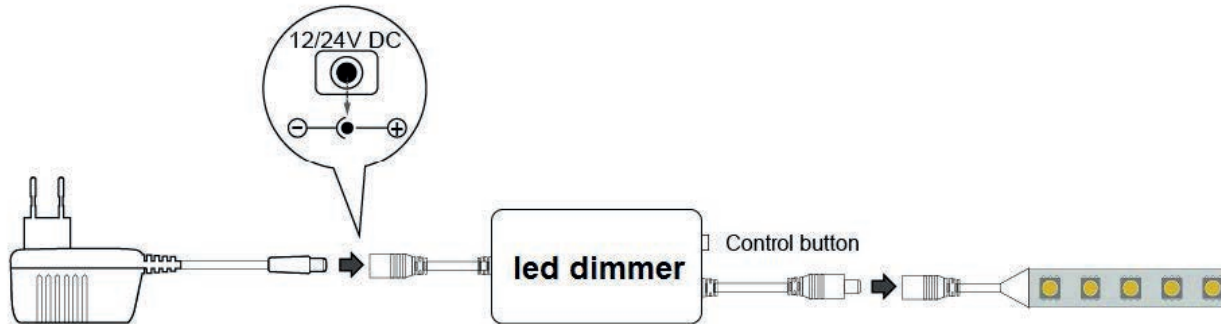

8. About RF Code

The biggest advantage of this system is that it can not only solve the cabling problem in engineering wirelessly, but also realize a wired-like operation experience. In order to facilitate the early testing and debugging of the project, the factory status of the receiver is normally unpaired and each remote controller has a unique code value. The user should perform the matching work of the remote controller and the receiver during the installation of the project to avoid the mutual influence of the radio frequency remote control technology during the later use.

Please pay attention to the following 3 points before operation:

- All equipment in the complete system after installation should have a unified and unique code value, so as to achieve the security and stability of the system.
- The receiver can only store one code value and cannot be overwritten. Before learning the new code value, it is necessary to clear the original code of the receiver; the remote controller can only save one code value but can be overwritten and can also restore the factory settings. In order to facilitate the later maintenance, the three components that may be involved in the system (including receivers, handheld remote controllers, and panel remote controllers) can realize mutual learning of code values.
- Since the receiver performs code value learning in the power-on state, batch-operation is available
(power-one the all receivers which will be in same zone, and operate the matching/clearing the RF code all of them at the same time). And in order to avoid confusion in the area, it is recommended that each area has an independent power switch so that the power of other areas can be easily cut off when the code is being operated.

1. Code pairing operation (means that the receiver will only be controlled by the value code remote controller)

2. Code clearing operation (means that the original code value of the receiver will be cleared and returned to the factory state. Then it can be controlled by any compatible remote control, and can learn to a new code)

Step	Operation	Instructions
1	Connecting the load to the receiver and power on it.	1.It is necessary to clear the code first, if the receiver was coded before. 2.Batch operation can be performed within the remote control range.
2	Press and hold "ON" on the remote control for 5 seconds, the indicator of the remote control will flash quickly, means it enters the pairing code transmission status.	Will automatically exit code transmission status after 60 seconds, or pressing any key to exit.
3	See the load light flashes 3 times and return to the initial state.	2 modes in total: fade or flash (speed is adjustable, brightness is unadjustable)

Step	Operation	Instructions
1	Connecting the load to the receiver and power on it.	1. The clearing operation should be finished within 1 minute after the receiver is powered on. If exceeds the time, can be powered on again. 2. Batch operation can be performed within the remote control range.
2	Press and hold the remote control "Off" for 5 seconds. The indicator of the remote control flashes quickly, means it enters the clearing code transmission status.	1. Will automatically exit code transmission status after 60 seconds, or pressing any key to exit. 2. If the original remote control is lost, the new remote control can be used for clearing operations.
3	See the load light flashes 3 times and return to the initial state.	Clearing coding is finished successfully.

3. Code learning operation between remote controls (used to unify system code values or copy a new remote controls)

Since each remote control has its own unique code at the time of delivery, when there are multiple remote controls in one system, one of them (for example, remote control A) must be selected as the system code value, and the code value of the rest remote controls (for example, remote control B) should be copied to the same one.

Step	Operation	Instructions
1	A remote control: Press and hold "ON" on the remote control for 5 seconds, the indicator of the remote control will flash quickly, means it enters the pairing code transmission status.	Will automatically exit code transmission status after 60 seconds, or pressing any key to exit.
2	B remote control: long press „mode key“ for 5 seconds, the remote indicator light changes from 100% light to off light, means entering the code value receiving state.	Will automatically exit the code value receiving state after 30 seconds, or exit after learning the code value successfully.
3	See the B remote control indicator light flash 3 times.	Code copying is finished and exit code value receiving status.

4. The remote controller restores the factory setting (it means that the remote control will be restored to the factory's unique code value)

Step	Operation	Instructions
1	Long press „mode“ for 20 seconds.	The remote indicator light dim down and flashes continuously until the 20th second and then back to 100% light. Means this step is finished.
2	Press „Off“ to confirm, the remote indicator light flashes 3 times	Restore factory settings successfully.

Attention!

1. In order to extend the life of the battery, the remote control will enter sleep mode without any operation for 10 seconds, please pressing any key to wake up it before using.
2. The signal of the touch ring/buttons is continuously transmitted for a maximum of 30 seconds, please release it and operate again if times out.



OCTANORM®-Vertriebs-GmbH

für Bauelemente
Raiffeisenstraße 39
70794 Filderstadt, Germany
T +49 711 77003 0
E info@octanorm.de

Adria

↗ octanormadria.com

Australia

↗ octanorm.com.au

Belgium

↗ octanorm.be

China

↗ octanorm.cn

Emirates

↗ octanormemirates.net

Espana

↗ octanorm.es

France

↗ octanorm.fr

Hellas

↗ octanorm.gr

Italia

↗ octanorm.com

Japan

↗ octanorm.co.jp

México

↗ octanorm.com.mx

Nigeria

↗ it-al.design

Nordic

↗ octanorm.se

North America

↗ octanormna.com

Polska

↗ octanorm.pl

South Africa

↗ octanorm.co.za

UK

↗ octanorm.uk

↗ octanorm.com